

Pushbutton Switch

A22

Install in 22-dia. or 25-dia. Panel Cutout

- Easy mounting and removal of Switch Unit.
- Increase wiring efficiency with three-row mounting of Switch Blocks.
- Finger protection mechanism on Switch Unit provided as a standard feature.
- Use 25-dia. ring to install in 25-dia. panel cutouts.
- Mounted using either open-type (fork-type) or closed-type (round-type) crimp terminals.
- Wide range of shapes and colors.
- IP65 oil resistance (non-lighted models)
IP65 (lighted models)
EN60947-5-1
- UL approved (File No. E41515)



Ordering Information

■ Model Number Legend (Completely Assembled)

Shipped as a set which includes the Pushbutton, Lamp (lighted type only), and Switch.

A22 ----

1 Lighted/Non-lighted

Code	Description
None	Non-lighted
L	Lighted

2 Flange Shape

Non-lighted	
Code	Description
F	Round/Flat
T	Round/Projection
G	Round/Full-guard
H	Round/Half-guard
C	Square/Projection
D	Square/Full-guard
S	Round/Mushroom (30-dia. head)
M	Round/Mushroom (40-dia. head)
Lighted	
T	Round/Projection
G	Round/Full-guard
H	Round/Half-guard
C	Square/Projection
D	Square/Full-guard

3 Illumination Color

Code	Description
R	Red
G	Green
Y	Yellow
W	White
A	Blue
B	Black (for non-lighted type only)

4 Light Source

Without Voltage Reduction Unit		
Code	Rated Voltage	
6D	LED	6 VDC
6A		6 VAC
12A		12 VAC/VDC
24A		24 VAC/VDC
5	Incandescent lamp	5 VAC/VDC
12		12 VAC/VDC
24		24 VAC/VDC
H1		100 VAC/VDC
With Voltage Reduction Unit		
T1	LED	110 VAC (See note 1)
T2		220 VAC (See note 2)

5 Contacts

Code	Description
10	SPST-NO
01	SPST-NC
11	SPST-NO + SPST-NC
20	DPST-NO
02	DPST-NC

Note: Refer to page 182 for contact ratings.

6 Switch Action

Code	Description
M	Momentary
A	Alternate

- Note:**
- Operational voltage: 95 to 115 VAC
 - Operational voltage: 190 to 230 VAC
 - The LED lamp (24 VAC/VDC) can be lit by directly applying 110 VAC/VDC (220 VAC/VDC) to the lamp terminal.
 - LED incorporates the 24-VAC/VDC type to the Voltage Reduction Unit models.

■ List of Models
Pushbutton Switch (Completely Assembled)
Non-lighted (Round Type)

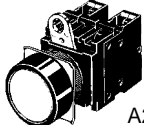
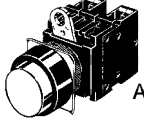
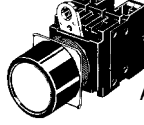
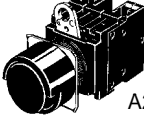
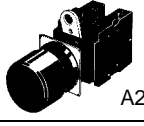
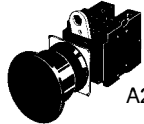
Appearance	Output	Momentary operation (self-resetting)	Alternate operation (self-holding)	Illumination color
Round/Flat type  A22-F	SPST-NO	A22-F□-10M	A22-F□-10A	Insert one of the following letters into the box □. R (red) Y (yellow) G (green) W (white) A (blue) B (black)
	SPST-NC	A22-F□-01M	A22-F□-01A	
	SPST-NO + SPST-NC	A22-F□-11M	A22-F□-11A	
	DPST-NO	A22-F□-20M	A22-F□-20A	
	DPST-NC	A22-F□-02M	A22-F□-02A	
Round/Projection type  A22-T	SPST-NO	A22-T□-10M	A22-T□-10A	
	SPST-NC	A22-T□-01M	A22-T□-01A	
	SPST-NO + SPST-NC	A22-T□-11M	A22-T□-11A	
	DPST-NO	A22-T□-20M	A22-T□-20A	
	DPST-NC	A22-T□-02M	A22-T□-02A	
Round/Full-guard type  A22-G	SPST-NO	A22-G□-10M	A22-G□-10A	
	SPST-NC	A22-G□-01M	A22-G□-01A	
	SPST-NO + SPST-NC	A22-G□-11M	A22-G□-11A	
	DPST-NO	A22-G□-20M	A22-G□-20A	
	DPST-NC	A22-G□-02M	A22-G□-02A	
Round/Half-guard type  A22-H	SPST-NO	A22-H□-10M	A22-H□-10A	Insert one of the following letters into the box □. R (red) Y (yellow) G (green) W (white) A (blue) B (black)
	SPST-NC	A22-H□-01M	A22-H□-01A	
	SPST-NO + SPST-NC	A22-H□-11M	A22-H□-11A	
	DPST-NO	A22-H□-20M	A22-H□-20A	
	DPST-NC	A22-H□-02M	A22-H□-02A	
Round/Small-size Mushroom type (30-dia. head)  A22-S	SPST-NO	A22-S□-10M	A22-S□-10A	
	SPST-NC	A22-S□-01M	A22-S□-01A	
	SPST-NO + SPST-NC	A22-S□-11M	A22-S□-11A	
	DPST-NO	A22-S□-20M	A22-S□-20A	
	DPST-NC	A22-S□-02M	A22-S□-02A	
Round/Medium-size Mushroom type (40-dia head)  A22-M	SPST-NO	A22-M□-10M	A22-M□-10A	
	SPST-NC	A22-M□-01M	A22-M□-01A	
	SPST-NO + SPST-NC	A22-M□-11M	A22-M□-11A	
	DPST-NO	A22-M□-20M	A22-M□-20A	
	DPST-NC	A22-M□-02M	A22-M□-02A	

Non-lighted (Square Type)

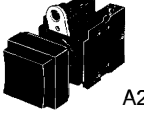
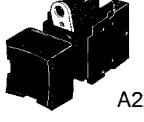
Appearance	Output	Momentary operation (self-reset)	Alternate operation (self-holding)	Illumination color
Square/Projection type  A22-C	SPST-NO	A22-C□-10M	A22-C□-10A	Insert one of the following letters into the box □. R (red) Y (yellow) G (green) W (white) A (blue) B (black)
	SPST-NC	A22-C□-01M	A22-C□-01A	
	SPST-NO + SPST-NC	A22-C□-11M	A22-C□-11A	
	DPST-NO	A22-C□-20M	A22-C□-20A	
	DPST-NC	A22-C□-02M	A22-C□-02A	
Square/Guard type  A22-D	SPST-NO	A22-D□-10M	A22-D□-10A	
	SPST-NC	A22-D□-01M	A22-D□-01A	
	SPST-NO + SPST-NC	A22-D□-11M	A22-D□-11A	
	DPST-NO	A22-D□-20M	A22-D□-20A	
	DPST-NC	A22-D□-02M	A22-D□-02A	

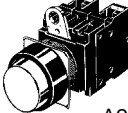
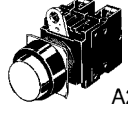
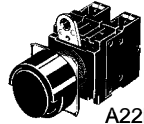

Lighted (Round Type)

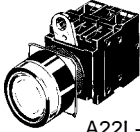
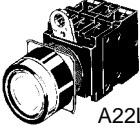
Appearance	Output	Lighting	Rated voltage	Momentary operation (self-resetting)	Alternate operation (self-holding)	Illumination color
Round/Projection type LED lighting (without Voltage Reduction Unit)  A22L-T	SPST-NO	LED	6 VDC	A22L-T□-6D-10M	A22L-T□-6D-10A	Insert one of the following letters into the box □. R (red) Y (yellow) G (green) W (white) A (blue)
			6 VAC	A22L-T□-6A-10M	A22L-T□-6A-10A	
			12 VAC/VDC	A22L-T□-12A-10M	A22L-T□-12A-10A	
			24 VAC/VDC	A22L-T□-24A-10M	A22L-T□-24A-10A	
	SPST-NC		6 VDC	A22L-T□-6D-01M	A22L-T□-6D-01A	
			6 VAC	A22L-T□-6A-01M	A22L-T□-6A-01A	
			12 VAC/VDC	A22L-T□-12A-01M	A22L-T□-12A-01A	
			24 VAC/VDC	A22L-T□-24A-01M	A22L-T□-24A-01A	
	SPST-NO + SPST-NC		6 VDC	A22L-T□-6D-11M	A22L-T□-6D-11A	
			6 VAC	A22L-T□-6A-11M	A22L-T□-6A-11A	
			12 VAC/VDC	A22L-T□-12A-11M	A22L-T□-12A-11A	
			24 VAC/VDC	A22L-T□-24A-11M	A22L-T□-24A-11A	
	DPST-NO		6 VDC	A22L-T□-6D-20M	A22L-T□-6D-20A	
			6 VAC	A22L-T□-6A-20M	A22L-T□-6A-20A	
			12 VAC/VDC	A22L-T□-12A-20M	A22L-T□-12A-20A	
			24 VAC/VDC	A22L-T□-24A-20M	A22L-T□-24A-20A	
DPST-NC	6 VDC	A22L-T□-6D-02M	A22L-T□-6D-02A			
	6 VAC	A22L-T□-6A-02M	A22L-T□-6A-02A			
	12 VAC/VDC	A22L-T□-12A-02M	A22L-T□-12A-02A			
	24 VAC/VDC	A22L-T□-24A-02M	A22L-T□-24A-02A			
Round/Projection type LED voltage-reduction lighting (with Voltage Reduction Unit)  A22L-T	SPST-NO	110 VAC	A22L-T□-T1-10M	A22L-T□-T1-10A	Insert one of the following letters into the box □. R (red) Y (yellow) G (green) W (white) A (blue)	
		220 VAC	A22L-T□-T2-10M	A22L-T□-T2-10A		
	SPST-NC	110 VAC	A22L-T□-T1-01M	A22L-T□-T1-01A		
		220 VAC	A22L-T□-T2-01M	A22L-T□-T2-01A		
	SPST-NO + SPST-NC	110 VAC	A22L-T□-T1-11M	A22L-T□-T1-11A		
		220 VAC	A22L-T□-T2-11M	A22L-T□-T2-11A		
	DPST-NO	110 VAC	A22L-T□-T1-20M	A22L-T□-T1-20A		
		220 VAC	A22L-T□-T2-20M	A22L-T□-T2-20A		
	DPST-NC	110 VAC	A22L-T□-T1-02M	A22L-T□-T1-02A		
		220 VAC	A22L-T□-T2-02M	A22L-T□-T2-02A		
	Round/Half-guard type LED lighting (without Voltage Reduction Unit)  A22L-H	SPST-NO	6 VDC	A22L-H□-6D-10M		A22L-H□-6D-10A
			6 VAC	A22L-H□-6A-10M		A22L-H□-6A-10A
12 VAC/VDC			A22L-H□-12A-10M	A22L-H□-12A-10A		
24 VAC/VDC			A22L-H□-24A-10M	A22L-H□-24A-10A		
SPST-NC		6 VDC	A22L-H□-6D-01M	A22L-H□-6D-01A		
		6 VAC	A22L-H□-6A-01M	A22L-H□-6A-01A		
		12 VAC/VDC	A22L-H□-12A-01M	A22L-H□-12A-01A		
		24 VAC/VDC	A22L-H□-24A-01M	A22L-H□-24A-01A		
SPST-NO + SPST-NC		6 VDC	A22L-H□-6D-11M	A22L-H□-6D-11A		
		6 VAC	A22L-H□-6A-11M	A22L-H□-6A-11A		
		12 VAC/VDC	A22L-H□-12A-11M	A22L-H□-12A-11A		
		24 VAC/VDC	A22L-H□-24A-11M	A22L-H□-24A-11A		
DPST-NO		6 VDC	A22L-H□-6D-20M	A22L-H□-6D-20A		
		6 VAC	A22L-H□-6A-20M	A22L-H□-6A-20A		
		12 VAC/VDC	A22L-H□-12A-20M	A22L-H□-12A-20A		
		24 VAC/VDC	A22L-H□-24A-20M	A22L-H□-24A-20A		
DPST-NC		6 VDC	A22L-H□-6D-02M	A22L-H□-6D-02A		
		6 VAC	A22L-H□-6A-02M	A22L-H□-6A-02A		
		12 VAC/VDC	A22L-H□-12A-02M	A22L-H□-12A-02A		
		24 VAC/VDC	A22L-H□-24A-02M	A22L-H□-24A-02A		

Appearance	Output	Lighting	Rated voltage	Momentary operation (self-resetting)	Alternate operation (self-holding)	Illumination color
Round/Half-guard type LED voltage-reduction lighting (with Voltage Reduction Unit)  A22L-H	SPST-NO	LED	110 VAC	A22L-H□-T1-10M	A22L-H□-T1-10A	Insert one of the following letters into the box □. R (red) Y (yellow) G (green) W (white) A (blue)
			220 VAC	A22L-H□-T2-10M	A22L-H□-T2-10A	
	SPST-NC		110 VAC	A22L-H□-T1-01M	A22L-H□-T1-01A	
			220 VAC	A22L-H□-T2-01M	A22L-H□-T2-01A	
	SPST-NO + SPST-NC		110 VAC	A22L-H□-T1-11M	A22L-H□-T1-11A	
			220 VAC	A22L-H□-T2-11M	A22L-H□-T2-11A	
	DPST-NO		110 VAC	A22L-H□-T1-20M	A22L-H□-T1-20A	
			220 VAC	A22L-H□-T2-20M	A22L-H□-T2-20A	
	DPST-NC		110 VAC	A22L-H□-T1-02M	A22L-H□-T1-02A	
			220 VAC	A22L-H□-T2-02M	A22L-H□-T2-02A	
Round/Full-guard type LED lighting (without Voltage Reduction Unit)  A22L-G	SPST-NO		6 VDC	A22L-G□-6D-10M	A22L-G□-6D-10A	
			6 VAC	A22L-G□-6A-10M	A22L-G□-6A-10A	
			12 VAC/VDC	A22L-G□-12A-10M	A22L-G□-12A-10A	
			24 VAC/VDC	A22L-G□-24A-10M	A22L-G□-24A-10A	
	SPST-NC		6 VDC	A22L-G□-6D-01M	A22L-G□-6D-01A	
			6 VAC	A22L-G□-6A-01M	A22L-G□-6A-01A	
			12 VAC/VDC	A22L-G□-12A-01M	A22L-G□-12A-01A	
			24 VAC/VDC	A22L-G□-24A-01M	A22L-G□-24A-01A	
	SPST-NO + SPST-NC		6 VDC	A22L-G□-6D-11M	A22L-G□-6D-11A	
			6 VAC	A22L-G□-6A-11M	A22L-G□-6A-11A	
		12 VAC/VDC	A22L-G□-12A-11M	A22L-G□-12A-11A		
		24 VAC/VDC	A22L-G□-24A-11M	A22L-G□-24A-11A		
	DPST-NO	6 VDC	A22L-G□-6D-20M	A22L-G□-6D-20A		
		6 VAC	A22L-G□-6A-20M	A22L-G□-6A-20A		
		12 VAC/VDC	A22L-G□-12A-20M	A22L-G□-12A-20A		
		24 VAC/VDC	A22L-G□-24A-20M	A22L-G□-24A-20A		
	DPST-NC	6 VDC	A22L-G□-6D-02M	A22L-G□-6D-02A		
		6 VAC	A22L-G□-6A-02M	A22L-G□-6A-02A		
		12 VAC/VDC	A22L-G□-12A-02M	A22L-G□-12A-02A		
		24 VAC/VDC	A22L-G□-24A-02M	A22L-G□-24A-02A		
Round/Full-guard type LED voltage-reduction lighting (with Voltage Reduction Unit)  A22L-G	SPST-NO	110 VAC	A22L-G□-T1-10M	A22L-G□-T1-10A		
		220 VAC	A22L-G□-T2-10M	A22L-G□-T2-10A		
	SPST-NC	110 VAC	A22L-G□-T1-01M	A22L-G□-T1-01A		
		220 VAC	A22L-G□-T2-01M	A22L-G□-T2-01A		
	SPST-NO + SPST-NC	110 VAC	A22L-G□-T1-11M	A22L-G□-T1-11A		
		220 VAC	A22L-G□-T2-11M	A22L-G□-T2-11A		
	DPST-NO	110 VAC	A22L-G□-T1-20M	A22L-G□-T1-20A		
		220 VAC	A22L-G□-T2-20M	A22L-G□-T2-20A		
	DPST-NC	110 VAC	A22L-G□-T1-02M	A22L-G□-T1-02A		
		220 VAC	A22L-G□-T2-02M	A22L-G□-T2-02A		

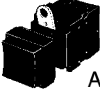
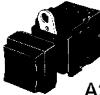
Lighted (Square Type)

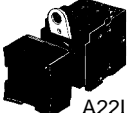
Appearance	Output	Lighting	Rated voltage	Momentary operation (self-resetting)	Alternate operation (self-holding)	Illumination color
Square/Projection type LED lighting (without Voltage Reduction Unit)  A22L-C	SPST-NO	LED	6 VDC	A22L-C□-6D-10M	A22L-C□-6D-10A	Insert one of the following letters into the box □. R (red) Y (yellow) G (green) W (white) A (blue)
			6 VAC	A22L-C□-6A-10M	A22L-C□-6A-10A	
			12 VAC/VDC	A22L-C□-12A-10M	A22L-C□-12A-10A	
			24 VAC/VDC	A22L-C□-24A-10M	A22L-C□-24A-10A	
	SPST-NC		6 VDC	A22L-C□-6D-01M	A22L-C□-6D-01A	
			6 VAC	A22L-C□-6A-01M	A22L-C□-6A-01A	
			12 VAC/VDC	A22L-C□-12A-01M	A22L-C□-12A-01A	
			24 VAC/VDC	A22L-C□-24A-01M	A22L-C□-24A-01A	
	SPST-NO + SPST-NC		6 VDC	A22L-C□-6D-11M	A22L-C□-6D-11A	
			6 VAC	A22L-C□-6A-11M	A22L-C□-6A-11A	
			12 VAC/VDC	A22L-C□-12A-11M	A22L-C□-12A-11A	
			24 VAC/VDC	A22L-C□-24A-11M	A22L-C□-24A-11A	
	DPST-NO		6 VDC	A22L-C□-6D-20M	A22L-C□-6D-20A	
			6 VAC	A22L-C□-6A-20M	A22L-C□-6A-20A	
			12 VAC/VDC	A22L-C□-12A-20M	A22L-C□-12A-20A	
			24 VAC/VDC	A22L-C□-24A-20M	A22L-C□-24A-20A	
	DPST-NC		6 VDC	A22L-C□-6D-02M	A22L-C□-6D-02A	
			6 VAC	A22L-C□-6A-02M	A22L-C□-6A-02A	
			12 VAC/VDC	A22L-C□-12A-02M	A22L-C□-12A-02A	
			24 VAC/VDC	A22L-C□-24A-02M	A22L-C□-24A-02A	
Square/Projection type LED voltage-reduction lighting (with Voltage Reduction Unit)  A22L-C	SPST-NO	110 VAC	A22L-C□-T1-10M	A22L-C□-T1-10A		
	SPST-NC	220 VAC	A22L-C□-T2-10M	A22L-C□-T2-10A		
		110 VAC	A22L-C□-T1-01M	A22L-C□-T1-01A		
	SPST-NO + SPST-NC	220 VAC	A22L-C□-T2-01M	A22L-C□-T2-01A		
		110 VAC	A22L-C□-T1-11M	A22L-C□-T1-11A		
	DPST-NO	220 VAC	A22L-C□-T2-11M	A22L-C□-T2-11A		
		110 VAC	A22L-C□-T1-20M	A22L-C□-T1-20A		
	DPST-NC	220 VAC	A22L-C□-T2-20M	A22L-C□-T2-20A		
		110 VAC	A22L-C□-T1-02M	A22L-C□-T1-02A		
			220 VAC	A22L-C□-T2-02M	A22L-C□-T2-02A	

Appearance	Output	Lighting	Rated voltage	Momentary operation (self-resetting)	Alternate operation (self-holding)	Illumination color
Square/Full-guard type LED lighting (without Voltage Reduction Unit)  A22L-D	SPST-NO	LED	6 VDC	A22L-D□-6D-10M	A22L-D□-6D-10A	Insert one of the following letters into the box □. R (red) Y (yellow) G (green) W (white) A (blue)
			6 VAC	A22L-D□-6A-10M	A22L-D□-6A-10A	
			12 VAC/VDC	A22L-D□-12A-10M	A22L-D□-12A-10A	
			24 VAC/VDC	A22L-D□-24A-10M	A22L-D□-24A-10A	
	SPST-NC		6 VDC	A22L-D□-6D-01M	A22L-D□-6D-01A	
			6 VAC	A22L-D□-6A-01M	A22L-D□-6A-01A	
			12 VAC/VDC	A22L-D□-12A-01M	A22L-D□-12A-01A	
			24 VAC/VDC	A22L-D□-24A-01M	A22L-D□-24A-01A	
	SPST-NO + SPST-NC		6 VDC	A22L-D□-6D-11M	A22L-D□-6D-11A	
			6 VAC	A22L-D□-6A-11M	A22L-D□-6A-11A	
			12 VAC/VDC	A22L-D□-12A-11M	A22L-D□-12A-11A	
			24 VAC/VDC	A22L-D□-24A-11M	A22L-D□-24A-11A	
	DPST-NO		6 VDC	A22L-D□-6D-20M	A22L-D□-6D-20A	
			6 VAC	A22L-D□-6A-20M	A22L-D□-6A-20A	
			12 VAC/VDC	A22L-D□-12A-20M	A22L-D□-12A-20A	
			24 VAC/VDC	A22L-D□-24A-20M	A22L-D□-24A-20A	
	DPST-NC		6 VDC	A22L-D□-6D-02M	A22L-D□-6D-02A	
			6 VAC	A22L-D□-6A-02M	A22L-D□-6A-02A	
			12 VAC/VDC	A22L-D□-12A-02M	A22L-D□-12A-02A	
			24 VAC/VDC	A22L-D□-24A-02M	A22L-D□-24A-02A	
Square/Full-guard type LED voltage-reduction lighting (with Voltage Reduction Unit)  A22L-D	SPST-NO	110 VAC	A22L-D□-T1-10M	A22L-D□-T1-10A		
	SPST-NC	220 VAC	A22L-D□-T2-10M	A22L-D□-T2-10A		
		110 VAC	A22L-D□-T1-01M	A22L-D□-T1-01A		
	SPST-NO + SPST-NC	220 VAC	A22L-D□-T2-01M	A22L-D□-T2-01A		
		110 VAC	A22L-D□-T1-11M	A22L-D□-T1-11A		
	DPST-NO	220 VAC	A22L-D□-T2-11M	A22L-D□-T2-11A		
		110 VAC	A22L-D□-T1-20M	A22L-D□-T1-20A		
	DPST-NC	220 VAC	A22L-D□-T2-20M	A22L-D□-T2-20A		
		110 VAC	A22L-D□-T1-02M	A22L-D□-T1-02A		
			220 VAC	A22L-D□-T2-02M	A22L-D□-T2-02A	

■ Model Number Legend (Subassembly)

The Pushbutton, Lamp, or Switch can be ordered separately. Use them in combination for models that are not available as assembled Units. These can also be used as inventory for maintenance parts.

Unit Combinations

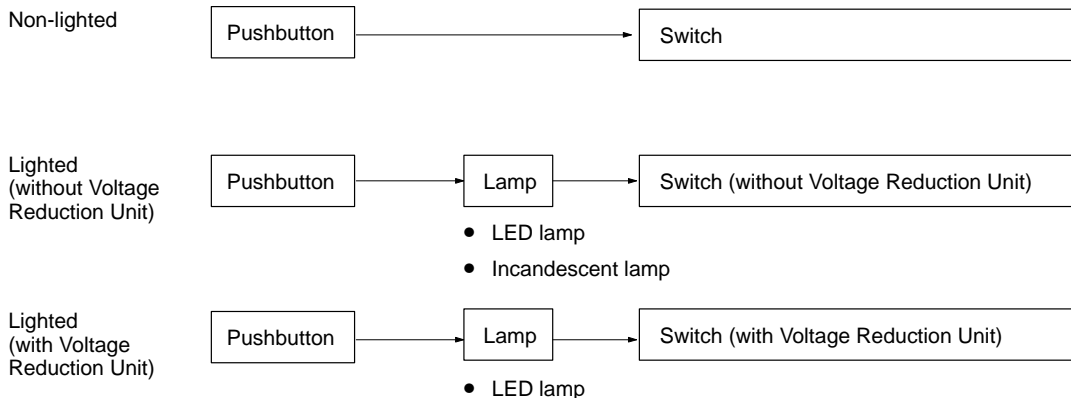

1. Pushbutton

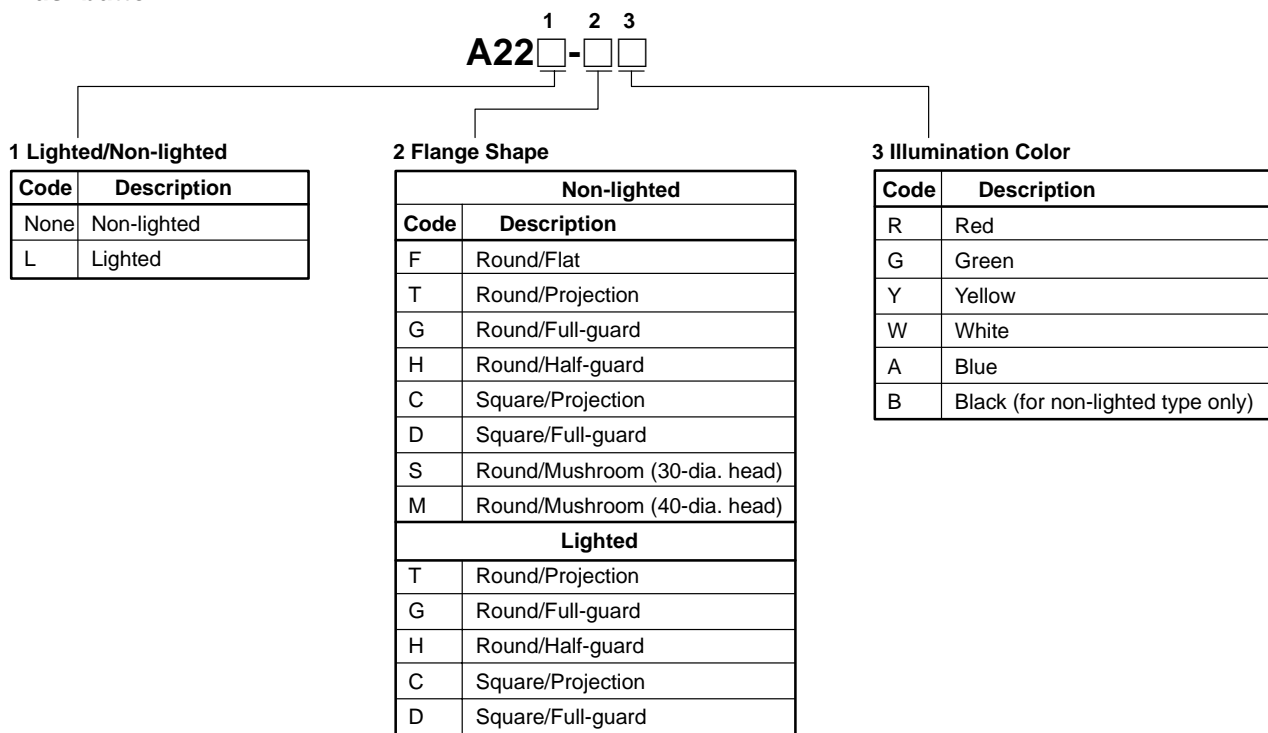

2. Lamp

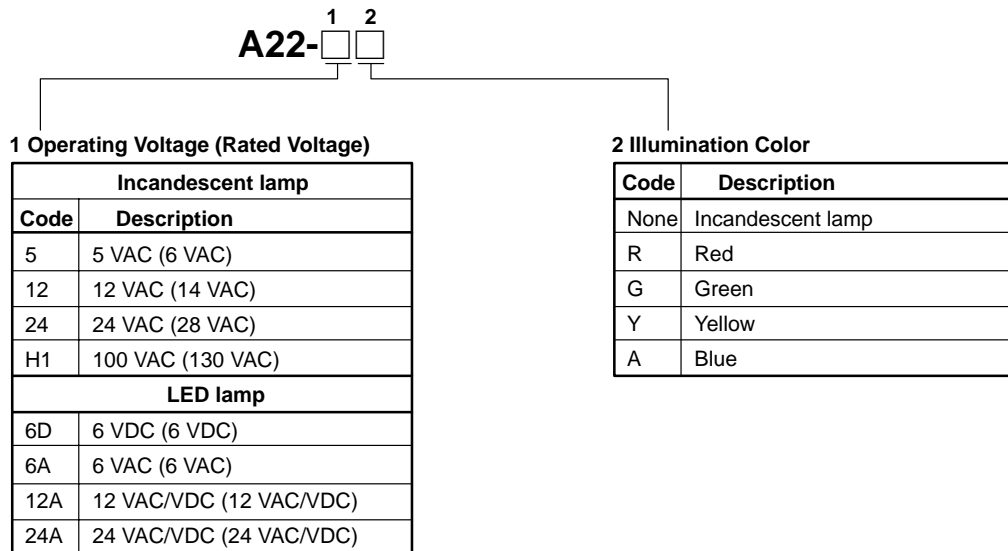

3. Switch (Standard Load)

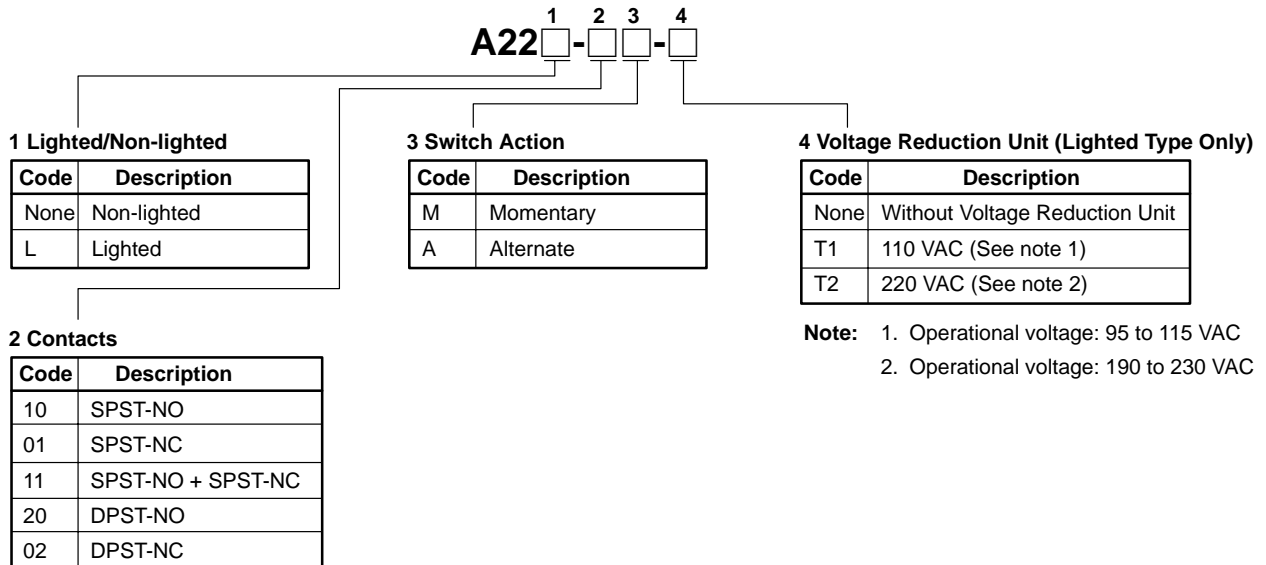









■ List of Models

Pushbutton Switches (Subassembly)



Pushbutton

Non-lighted



Color	IP65 oil-resistant models			
	Flat type 	Projection type 	Full-guard type 	Half-guard type 
Red	A22-FR	A22-TR	A22-GR	A22-HR
Green	A22-FG	A22-TG	A22-GG	A22-HG
Yellow	A22-FY	A22-TY	A22-GY	A22-HY
White	A22-FW	A22-TW	A22-GW	A22-HW
Blue	A22-FA	A22-TA	A22-GA	A22-HA
Black	A22-FB	A22-TB	A22-GB	A22-HB

Color	IP65 oil-resistant models			
	Square/Projection type 	Square/Full-guard type 	Round/Mushroom type (30-dia. head) 	Round/Mushroom type (40-dia. head) 
Red	A22-CR	A22-DR	A22-SR	A22-MR
Green	A22-CG	A22-DG	A22-SG	A22-MG
Yellow	A22-CY	A22-DY	A22-SY	A22-MY
White	A22-CW	A22-DW	A22-SW	A22-MW
Blue	A22-CA	A22-DA	A22-SA	A22-MA
Black	A22-CB	A22-DB	A22-SB	A22-MB

Lighted

Color	IP65		
	Projection type 	Full-guard type 	Half-guard type 
Red	A22L-TR	A22L-GR	A22L-HR
Green	A22L-TG	A22L-GG	A22L-HG
Yellow	A22L-TY	A22L-GY	A22L-HY
White	A22L-TW	A22L-GW	A22L-HW
Blue	A22L-TA	A22L-GA	A22L-HA

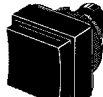
Note: Common to incandescent lamps and LED lamps.

Color	IP65	
	Square/Projection 	Square/Full-guard type 
Red	A22L-CR	A22L-DR
Green	A22L-CG	A22L-DG
Yellow	A22L-CY	A22L-DY
White	A22L-CW	A22L-DW
Blue	A22L-CA	A22L-DA

Lamp

LED Lamp

Appearance	Rated voltage		6 V	12 V	24 V	24 V Super-bright
	AC/DC	LED light	Model			
	DC	Red	A22-6DR	---	---	---
		Green	A22-6DG	---	---	---
		Yellow (See note 2.)	A22-6DY	---	---	---
		Blue	A22-6DA	---	---	---
	AC	Red	A22-6AR	---	---	---
		Green	A22-6AG	---	---	---
		Yellow (See note 2.)	A22-6AY	---	---	---
		Blue	A22-6AA	---	---	---
	AC and DC	Red	---	A22-12AR	A22-24AR	A22-24ASR
		Green	---	A22-12AG	A22-24AG	A22-24ASG
		Yellow (See note 2.)	---	A22-12AY	A22-24AY	A22-24ASY
		Blue	---	A22-12AA	A22-24AA	A22-24ASA

- Note:** 1. For voltage-reduction lighting, use the A22-24A□.
2. Used when the Pushbutton color is yellow or white.

Incandescent Lamp

Rated voltage	6 VAC/VDC	14 VAC/VDC	28 VAC/VDC	130 VAC/VDC
	A22-5	A22-12	A22-24	A22-H1

Switch (Standard Load)

Non-lighted

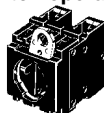
Switch operation	Contacts	Model
	SPST-NO	A22-10M
	SPST-NC	A22-01M
	SPST-NO + SPST-NC	A22-11M
	DPST-NO	A22-20M
	DPST-NC	A22-02M
Alternate	SPST-NO	A22-10A
	SPST-NC	A22-01A
	SPST-NO + SPST-NC	A22-11A
	DPST-NO	A22-20A
	DPST-NC	A22-02A

Lighted

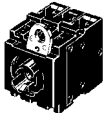
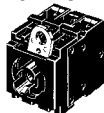
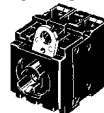
Switch operation	Contacts	Voltage reduction circuits		
		Without Voltage Reduction Unit 	With Voltage Reduction Unit	
			110 VAC 	220 VAC 
Momentary	SPST-NO	A22L-10M	A22L-10M-T1	A22L-10M-T2
	SPST-NC	A22L-01M	A22L-01M-T1	A22L-01M-T2
	SPST-NO + SPST-NC	A22L-11M	A22L-11M-T1	A22L-11M-T2
	DPST-NO	A22L-20M	A22L-20M-T1	A22L-20M-T2
	DPST-NC	A22L-02M	A22L-02M-T1	A22L-02M-T2
Alternate	SPST-NO	A22L-10A	A22L-10A-T1	A22L-10A-T2
	SPST-NC	A22L-01A	A22L-01A-T1	A22L-01A-T2
	SPST-NO + SPST-NC	A22L-11A	A22L-11A-T1	A22L-11A-T2
	DPST-NO	A22L-20A	A22L-20A-T1	A22L-20A-T2
	DPST-NC	A22L-02A	A22L-02A-T1	A22L-02A-T2

- Note:** 1. The above diagrams show the DPST-NO contact models as representative examples.
2. For voltage-reduction lighting, use the A22-24A□.

Nomenclature

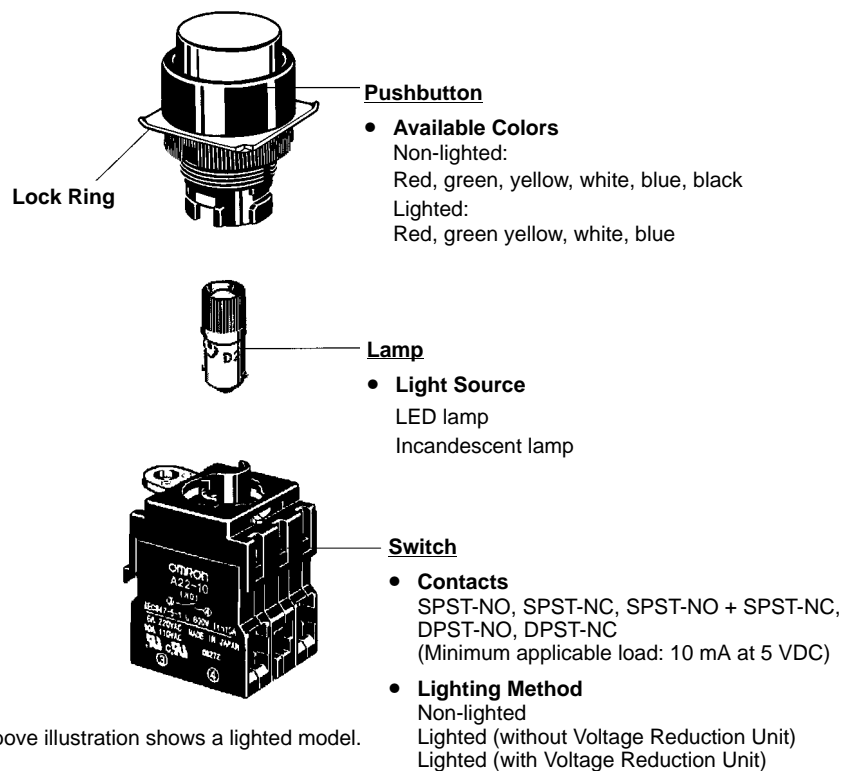

Refer to pages 182 onwards for specifications, accessories, installation, and precautions.

Dimensions

Note: 1. All units are in millimeters unless otherwise indicated.
 2. The following illustrations are for momentary operation.

■ Lighted/Non-lighted Pushbutton Switches

**Flat Type
A22-F**

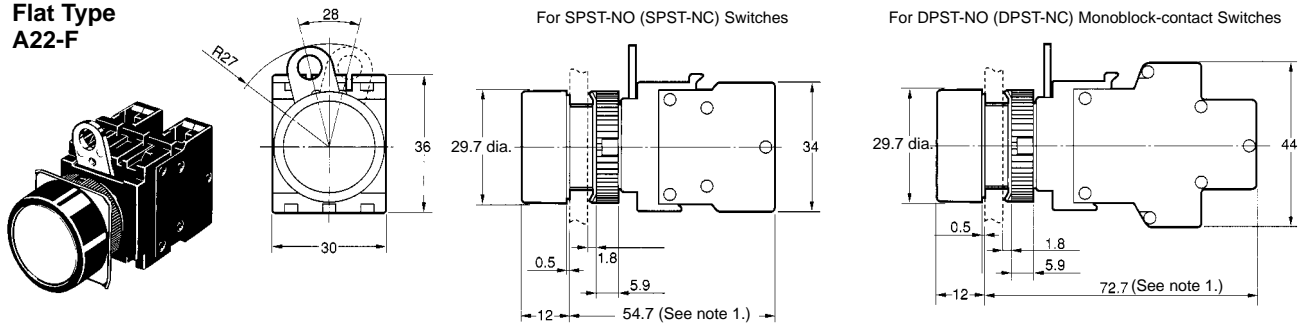

**Round/Half-guard Type
A22-H, A22L-H**

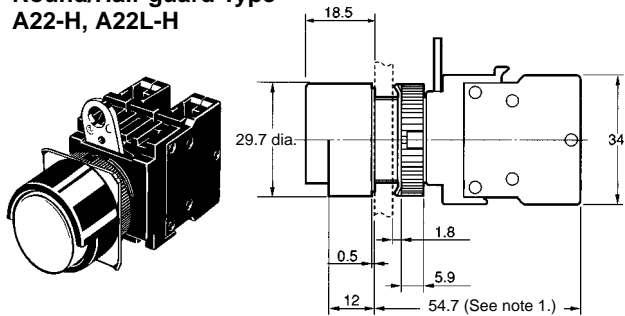

**Round/Projection Type
A22-T, A22L-T**

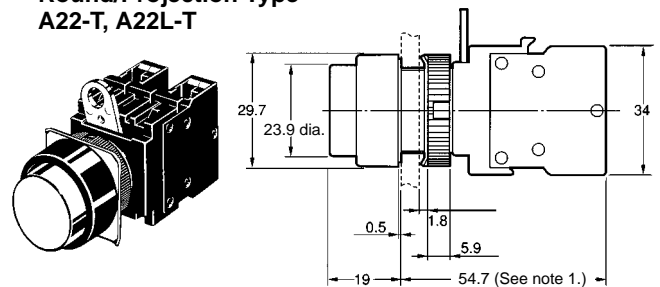

**Round/Full-guard Type
A22-G, A22L-G**

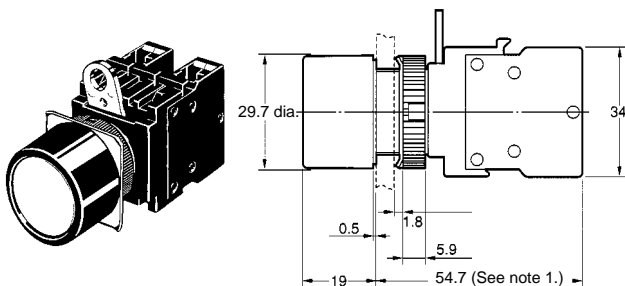

**40-dia. Mushroom Type
A22-M**

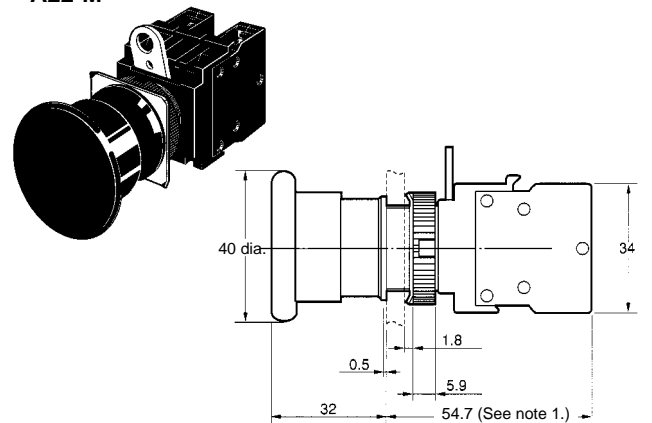

**Square/Projection Type
A22-C, A22L-C**

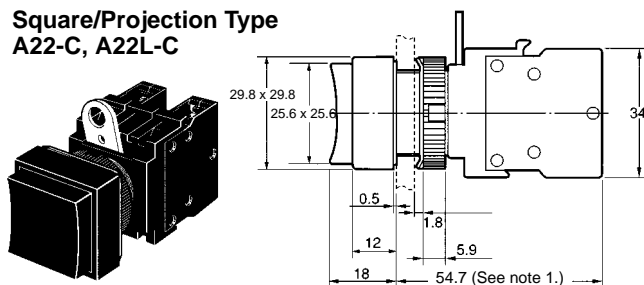

**Square/Full-guard Type
A22-D, A22L-D**

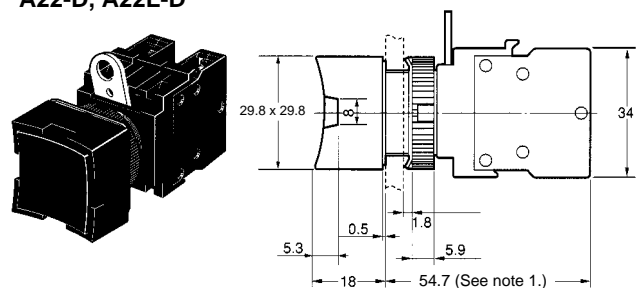

Note: 1. Alternate operation models are 9.3 mm longer.
 2. Lighted models have the same dimensions as shown above, whether they are with or without Voltage Reduction Units.

■ Terminal Arrangement

Terminal Arrangement (Bottom View)

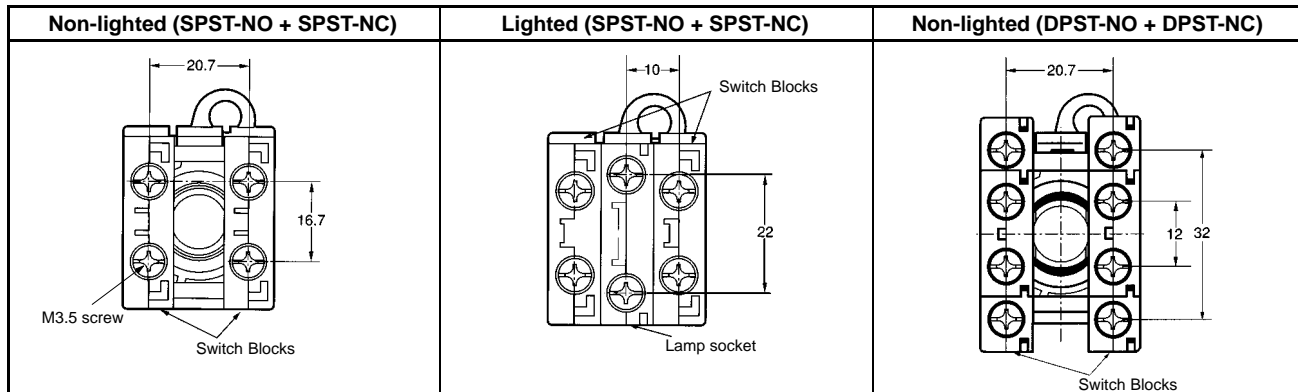

Terminal Connection

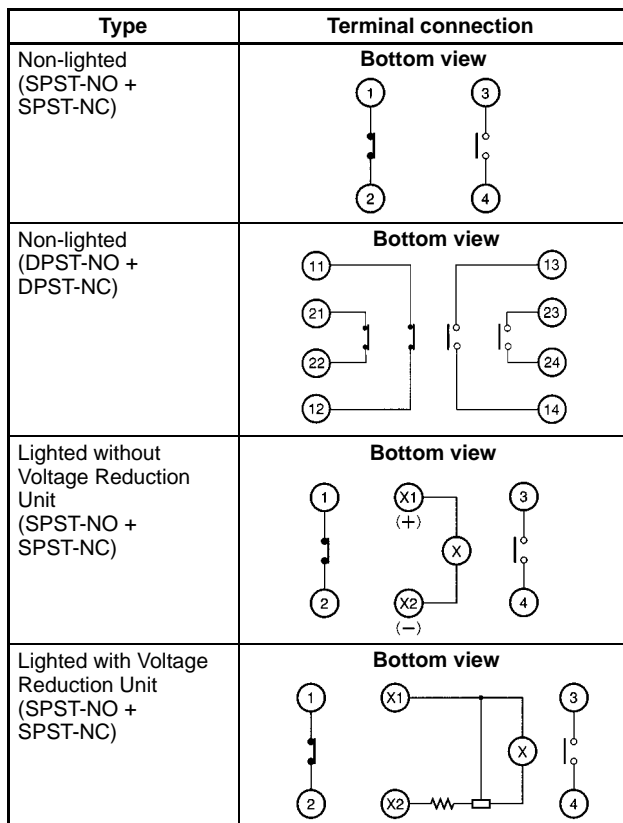

Panel Cutout Dimensions

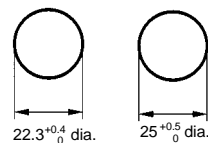

- Note:**
1. When applying coating such as paint to the panel, the dimensions should be those after the application of coating. Lock ring is provided as a standard item.
 2. Recommended panel thickness: 1 to 5 mm.
 3. Use an A22Z-R25 Ring when mounting to a panel with 25-mm holes.

ALL DIMENSIONS SHOWN ARE IN MILLIMETERS.
 To convert millimeters into inches, multiply by 0.03937. To convert grams into ounces, multiply by 0.03527.