

EVF044

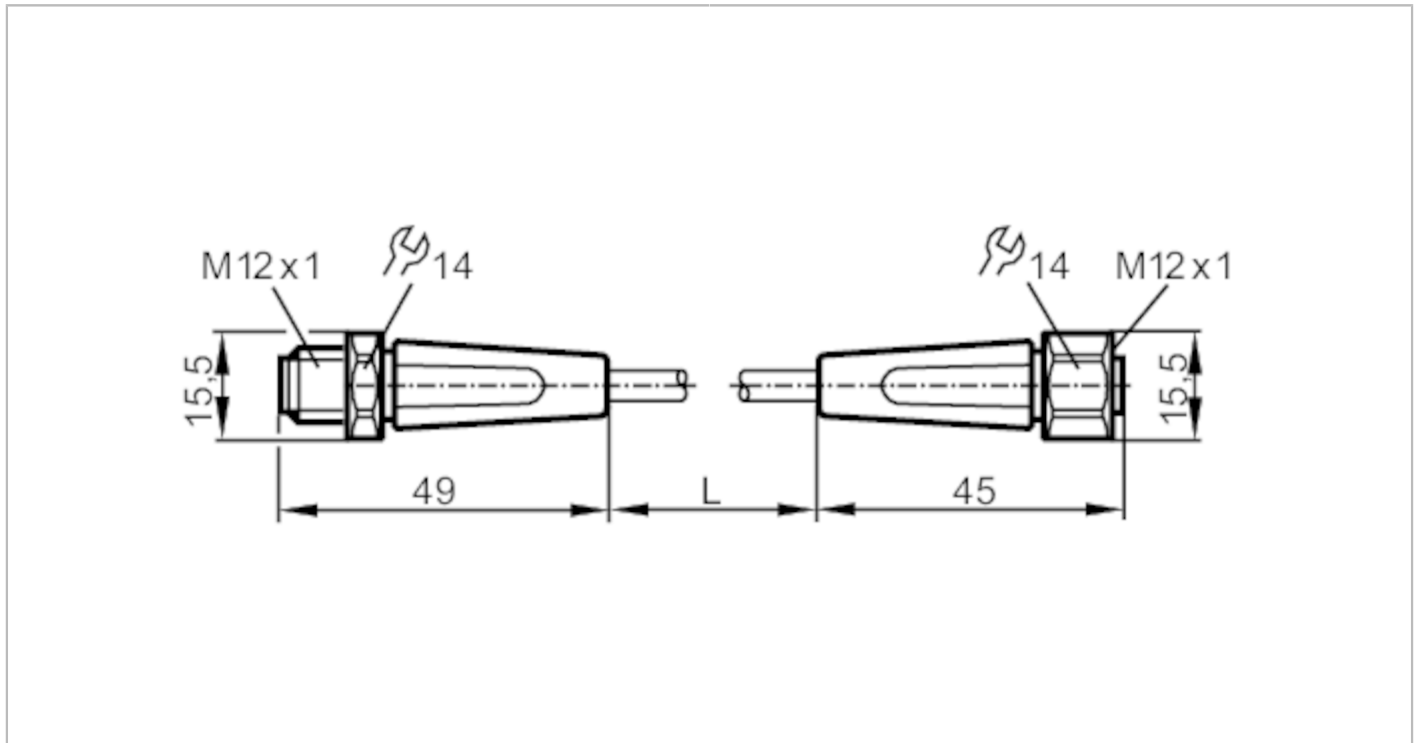

Connection cable

VDOGH040VAS0005P04STGH040VAS



Application		
Application	sanitary and wet areas in the food industry	
Free from silicone	yes	
Electrical data		
Operating voltage [V]	< 250 AC / < 300 DC	
Protection class	II	
Max. current load total [A]	4; (cULus: 3)	
Operating conditions		
Ambient temperature [°C]	-25...100	
Note on ambient temperature	cULus: ...65 °C	
Ambient temperature (moving) [°C]	0...100	
Note on ambient temperature (moving)	cULus: ...65 °C	
Protection	IP 65; IP 67; IP 68; IP 69K	
Mechanical data		
Weight [g]	175.2	
Material	PP Halogen-free; sealing: EPDM	
Material nut	stainless steel (1.4404 / 316L) / stainless steel (1.4404 / 316L)	
Drag chain suitability	Bending radius for flexible applications	min. 10 x cable diameter
	Travel speed	max. 3.3 m/s for a horizontal travel length of 5 m and max. acceleration of 5 m/s ²
	Bending cycles	> 1 Mio.
	Torsional strain	± 180 °/m
Drag chain suitability	yes	

EVF044



Connection cable

VDOGH040VAS0005P04STGH040VAS

Remarks

Pack quantity

1 pcs.

Electrical connection - plug

Connector: 1 x M12, straight; Moulded body: PP, Halogen-free; Locking: stainless steel (1.4404 / 316L); Contacts: gold-plated; Tightening torque: 0.6...1.2 Nm



Electrical connection

Cable: 5 m, MPPE, Halogen-free, grey, Ø 4.9 mm; 4 x 0.34 mm² (42 x Ø 0.1 mm)

Connection

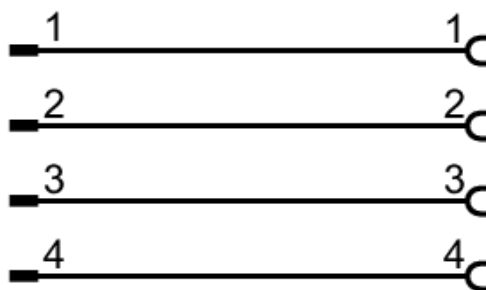

Electrical connection - Socket

Connector: 1 x M12, straight; Moulded body: PP, Halogen-free; Locking: stainless steel (1.4404 / 316L); Contacts: gold-plated; Tightening torque: 0.6...1.5 Nm

