

REAL TIME CLOCK MODULE (SPI-Bus)
Built-in 32.768 kHz-DTCXO, High Stability

RX-4803 SA/LC

- Built in frequency adjusted 32.768 kHz crystal unit and DTCXO.
- 1/100s resolution Time register
- Interface Type : 4-wire serial interface
- Interface voltage range : 1.6 V to 5.5 V
- Temp. compensated voltage range : 2.2 V to 5.5 V
- Clock supply voltage range : 1.6 V to 5.5 V
- Selectable clock output (32.768 kHz, 1024 Hz, 1 Hz)
- The various functions include full calendar, alarm, timer, EVIN input. Epson is prepared Linux driver for this product.
http://www5.epsondevice.com/en/quartz/tech/linux_for_rtc/index.html
- The registered trademark Linux® is used pursuant to a sublicense from LMI(Linux Mark Institute)



Product Number (Please contact us)
 RX-4803SA: X1B000132xxxx00
 RX-4803LC: X1B000122xxxx00

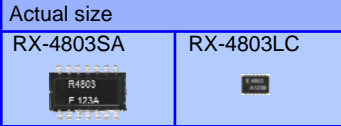
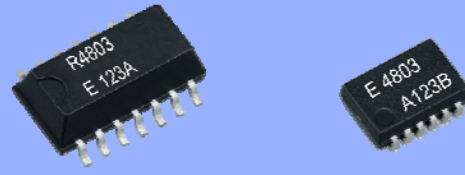

Block diagram

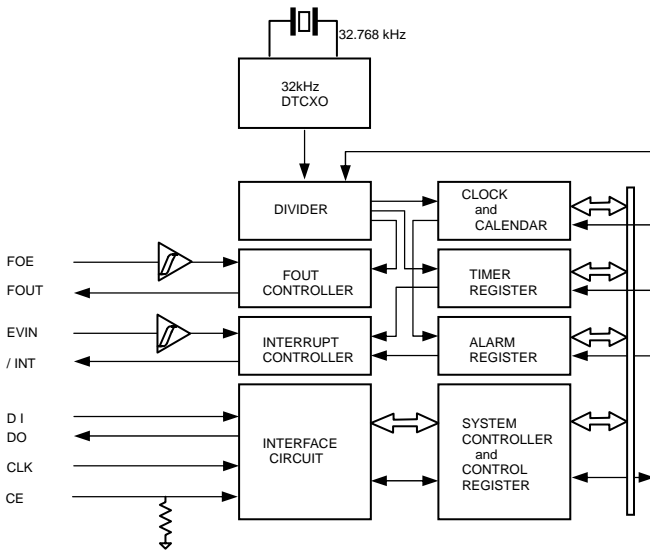

Overview

- **High Stability**
 - UA $\pm 3.4 \times 10^{-6}$ / -40 °C to +85 °C (Equivalent to 9 seconds of month deviation)
 - UB $\pm 5.0 \times 10^{-6}$ / -40 °C to +85 °C (Equivalent to 13 seconds of month deviation)
 - UC $\pm 5.0 \times 10^{-6}$ / -30 °C to +70 °C
 - AA $(+5 \pm 5.0) \times 10^{-6}$ / +25 °C
- **High Resolution:** 1/100s Time register with capture buffer
- **32.768 kHz frequency output function**
 - FOUT pin output (C-MOS output), CL=30 pF
 - Output selectable: 32.768 kHz, 1024 Hz, 1 Hz
- **The various interrupt**
 - Timer Function can be set between 1/ 4096 second and 4095 minutes.
 - Alarm Function can be set to day of week, day, hour, or minute.
 - EVIN input.
- **Time synchronize function with 1PPS signal input**
- **Register compatibility:** upper compatible with RX-4801.

*It is possible to use it by the terminal connection as 32.768 kHz-DTCXO.

Pin Function

Signal Name	I / O	Function
CE	input	The chip enable input pin.
CLK	input	The shift clock input pin for serial data transfer.
FOUT	Output	The pin outputs the reference clock signal. (CMOS output)
TEST	input	Use by the manufacture for testing. (Do not connect externally. RX-4803SA only.)
VDD	-	Connected to a positive power supply
FOE	input	The input pin for the FOUT output control.
EVIN	input	External event input.
/INT	Output	Interrupt output (N-ch. open drain).
GND	-	Connected to a ground
T2(VPP)	-	Use by the manufacture for testing. (Do not connect externally.)
DO	Output	The data output pin for serial data transfer.
DI	input	The data input pin for serial data transfer.

Terminal connection / External dimensions

(Unit:mm)

RX - 4803 SA

SOP - 14 pin

RX - 4803 LC

VSQJ - 12pin

The metal case inside of the molding compound may be exposed on the top or bottom of this product. This purely cosmetic and does not have any effect on quality, reliability or electrical specs.

***Stop using the glue**
 Any glue must never use it after soldering LC-package to a circuit board. This product has glass on the back side of a package. When glue invasions between circuit board side and glass side, then glass cracks by thermal expansion of glue. In this case a crystal oscillation stops. Consider glue abolition or glue do not touch to LC-package

Specifications (characteristics)

* Refer to application manual for details.

■ Electrical Characteristics

Item	Symbol	Conditions	Min.	Typ.	Max.	Unit	
Interface voltage	VDD	Interface voltage	1.6	3.0	5.5	V	
Temp. compensated Voltage	VTEM	Temp. compensated voltage	2.2	3.0	5.5	V	
Clock supply voltage	VCLK	-	1.6	3.0	5.5	V	
Operating temperature	TOPR	No condensation	-40	+25	+85	°C	
Stability	$\Delta f / f$	UA	Ta = -40 °C to +85 °C	± 3.4 *1		$\times 10^{-6}$	
		UB	Ta = -40 °C to +85 °C	± 5.0 *2			
		UC	Ta = -30 °C to +70 °C	± 5.0 *3			
		AA	Ta = +25 °C	5 ± 5.0 *3			
Current consumption (1)	I _{DD1}	Backup Mode FOE = GND, /INT = VDD FOUT output : OFF	VDD = 5V	-	0.75	3.4	μ A
Current consumption (2)	I _{DD2}		VDD = 3V	-	0.75	2.1	μ A

*1) Equivalent to 9 seconds of month deviation. *2) Equivalent to 13 seconds of month deviation.
 *3) Equivalent to 13 seconds of month deviation. (excluding offset)

■ 32.768 kHz-DTCXO Frequency temperature characteristics (Example)

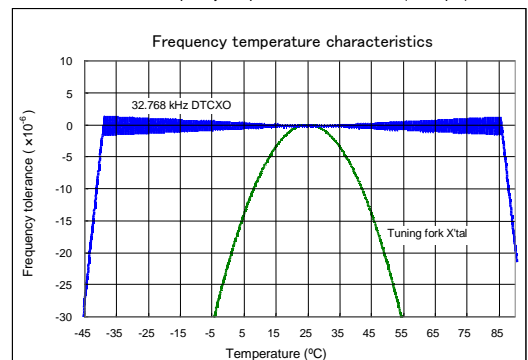

PROMOTION OF ENVIRONMENTAL MANAGEMENT SYSTEM CONFORMING TO INTERNATIONAL STANDARDS

At Seiko Epson, all environmental initiatives operate under the Plan-Do-Check-Action (PDCA) cycle designed to achieve continuous improvements. The environmental management system (EMS) operates under the ISO 14001 environmental management standard.

All of our major manufacturing and non-manufacturing sites, in Japan and overseas, completed the acquisition of ISO 14001 certification.

ISO 14000 is an international standard for environmental management that was established by the International Standards Organization in 1996 against the background of growing concern regarding global warming, destruction of the ozone layer, and global deforestation.





WORKING FOR HIGH QUALITY

In order provide high quality and reliable products and services than meet customer needs,

Seiko Epson made early efforts towards obtaining ISO9000 series certification and has acquired ISO9001 for all business establishments in Japan and abroad. We have also acquired ISO/TS 16949 certification that is requested strongly by major automotive manufacturers as standard.

ISO/TS16949 is the international standard that added the sector-specific supplemental requirements for automotive industry based on ISO9001.

► Explanation of the mark that are using it for the catalog

	► Pb free.
	► Complies with EU RoHS directive. *About the products without the Pb-free mark. Contains Pb in products exempted by EU RoHS directive. (Contains Pb in sealing glass, high melting temperature type solder or other.)
	► Designed for automotive applications such as Car Multimedia, Body Electronics, Remote Keyless Entry etc.
	► Designed for automotive applications related to driving safety (Engine Control Unit, Air Bag, ESC etc.)

Notice

- This material is subject to change without notice.
- Any part of this material may not be reproduced or duplicated in any form or any means without the written permission of Seiko Epson.
- The information about applied circuitry, software, usage, etc. written in this material is intended for reference only. Seiko Epson does not assume any liability for the occurrence of infringing on any patent or copyright of a third party. This material does not authorize the licensing for any patent or intellectual copyrights.
- When exporting the products or technology described in this material, you should comply with the applicable export control laws and regulations and follow the procedures required by such laws and regulations.
- You are requested not to use the products (and any technical information furnished, if any) for the development and/or manufacture of weapon of mass destruction or for other military purposes. You are also requested that you would not make the products available to any third party who may use the products for such prohibited purposes.
- These products are intended for general use in electronic equipment. When using them in specific applications that require extremely high reliability, such as the applications stated below, you must obtain permission from Seiko Epson in advance.
/ Space equipment (artificial satellites, rockets, etc.) / Transportation vehicles and related (automobiles, aircraft, trains, vessels, etc.) / Medical instruments to sustain life / Submarine transmitters / Power stations and related / Fire work equipment and security equipment / traffic control equipment / and others requiring equivalent reliability.
- All brands or product names mentioned herein are trademarks and/or registered trademarks of their respective.