

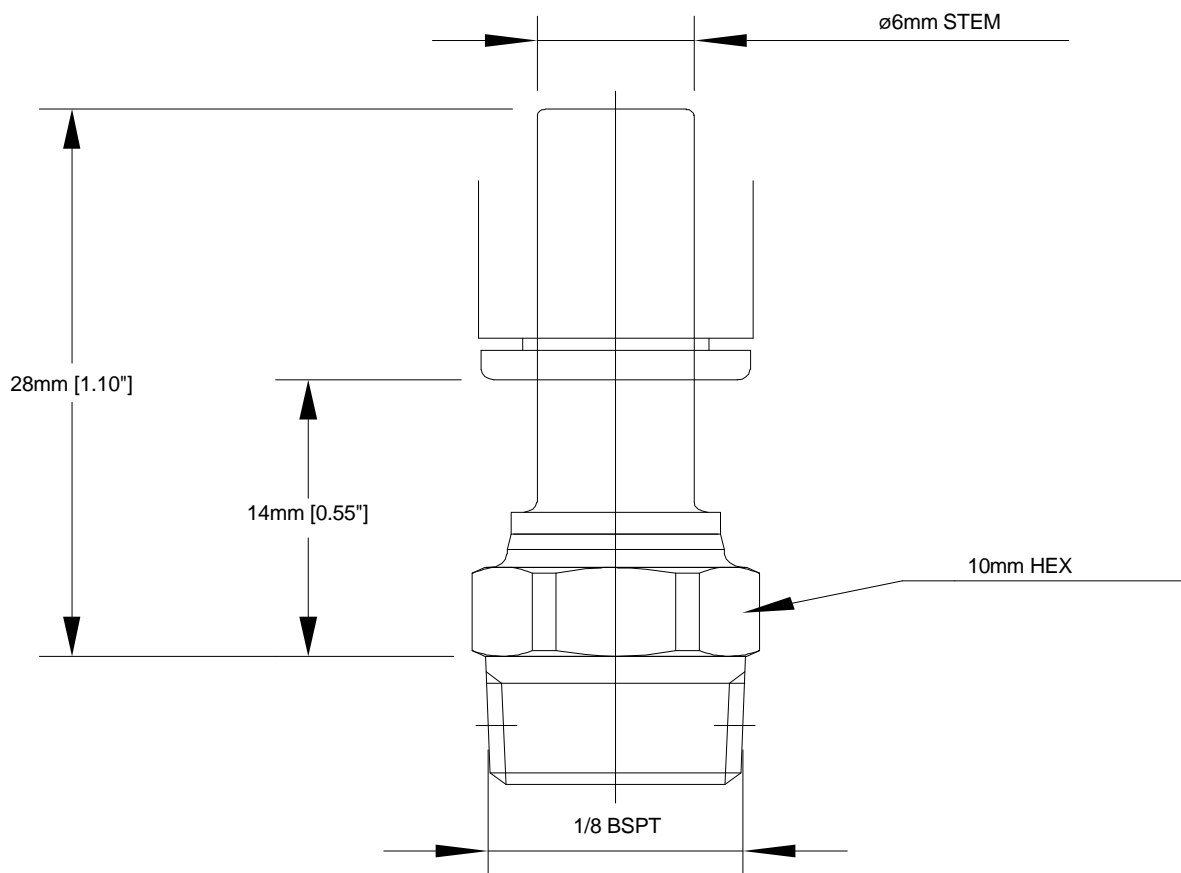

3121 06 10



Legris has a policy of continual product development and reserves the right to change dimensions or specifications without prior notification.

Nous nous reservons le droit d'apporter toute modification dans la conception et la realisation de nos materiels.
Nos cotes sont donnees a titre indicatif.