

Features

- Double Shut Off
- Ball Lock
- Operating Temperature from -25 °C to +125 °C
- ISO 7241-1 Serie B
- Stainless Steel 303
- Interchangeable:

Hansen HK Series
Parker 60 Series
Rectus 71-72-73-74-75-76 Series
Faster HNV Serie
ISO 7241-1 Serie B

RS PRO Hydraulic Quick Connect Couplings

RS Stock No.: 0727341



RS PRO is the own brand of RS. The RS PRO Seal of Approval is your assurance of professional quality, a guarantee that every part is rigorously tested, inspected, and audited against demanding standards. Making RS PRO the Smart Choice for our customers.

Product Description

Functions: If socket and plug valves seal instantly, automatically shutting off fluid flow to prevent leakage. If the socket and plug valves pushed together, opening to permit free flow to of fluid through coupler. O-Ring in the socket seals the plug surface preventing any leakage.

Applications:

- High pressure hydraulic circuits
- Connection of hydraulic pumps, valves, and quick tools change
- Aluminium die casting
- Test Benches
- Plastic industry tool changing
- Steel Industry

Attention: Only plug and socket with the same thread fit together

Interchangeability:

- Hansen HK Series
- Parker 60 Series
- Rectus 71-72-73-74-75-76 Series
- Faster HNV Serie
- ISO 7241-1 Serie B

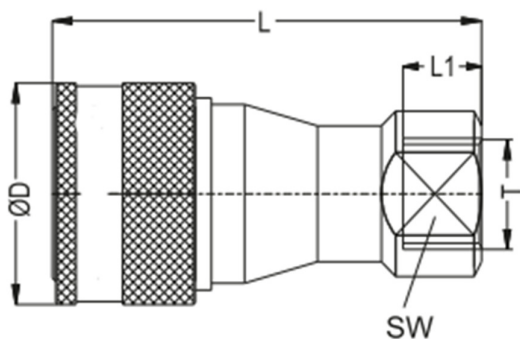

Female Thread Coupler

 Double Shut-off

T Connection	SW (mm)	ØD (mm)	L (mm)
G 1/4"	19	28.2	56.3

Specifications

Manufacturer Series	70
Standards Met	ISO 7241 Serie B
Compatible with	Hansen HK Series Parker 60 Series Rectus 71-72-73-74-75-76 Series Faster HNV Serie
Maximum Operating Pressure	250 Bar
Minimum Operating Temperature	-25 °C
Maximum Operating Temperature	+125 °C
Type	Quick Connect Coupling
Locking Style	Ball Lock
Double Shut Off	Double Shut Off
Thread Size	1/4 in
Thread Standard	G
Thread Gender	Female
Coupling Gender	Female
Thread	G 1/4 in Female
Material	Stainless Steel 303
Finish	AISI 303
Seal Material	Nitrile Rubber
Sleeve Material	AISI-303
Valve Material	AISI-303
Spring Material	14310
Locking O Ring Material	Nitrile Rubber
Ball Material	AISI-316

