

Bourdon tube pressure gauges, liquid filled,

Modelcode type: 213.53.0XX

Item number: 82493296

Description

Design according	EN 837-1
Accuracy class	class 1.6
Scale range	0...25 MPa
2nd Scale or Special Scale	2nd scale psi

Constructional design

Process connection	G 1/4 B
Connector location	back mount
Pressure element	Copper alloy
Movement	Copper alloy
Case	Crimp ring case (version 53)
Nominal size	063 mm
Restrictor	brass, D 0.5
Case filling fluid	glycerine
Pointer	plastic, black (double division)
Window	plastic, clear
Dial	Aluminum, white, with stop-pin

Options

Mounting flange/bracket	narrow panel ring, SS,rolled on,with mounting bracket
-------------------------	---

Operating conditions

Pressure limitation	Steady: 3/4 x full scale value Fluctuating: 2/3 x full scale value Short time: Full scale value
Permissible ambient temperature	-20 ... +60 °C
Permissible medium temperature	+60°C maximum
Temperature effect when the temperature deviates from the reference temperature (+20°C)	Max. +0.4 %/10 K of the span

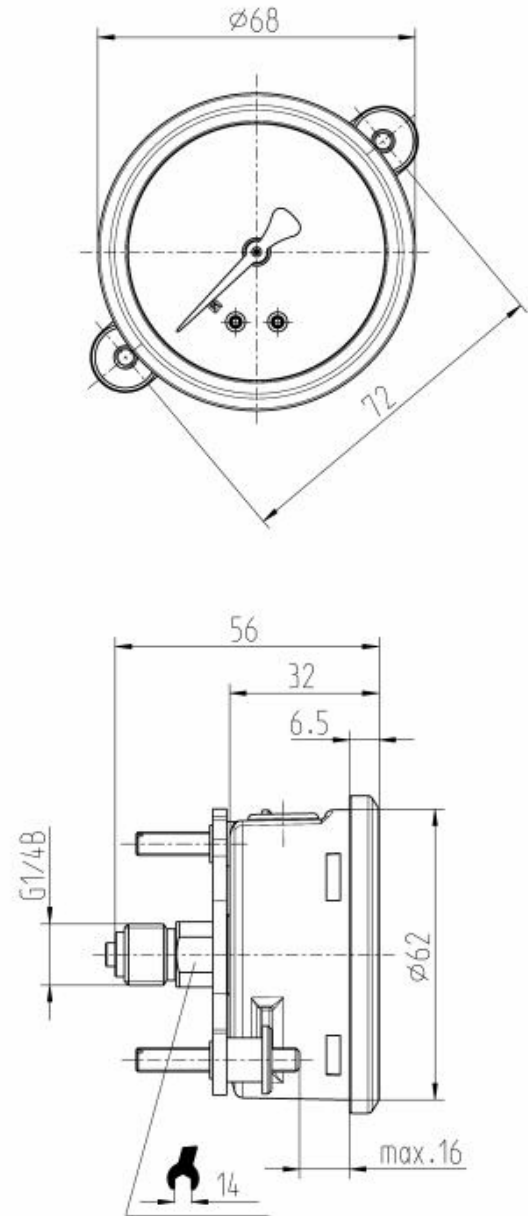

Bourdon tube pressure gauges, liquid filled,

Modelcode type: 213.53.0XX

Item number: 82493296

Ingress protection IP 65

Dial description:

Pressure Gauge Standard International (standard Europe)

color for 1.scale (outside) black

color for 2.scale (inside) red RAL 3020

dial background White

Manufacturer logo *WIKA*

stop pin on dial at zero

norm-mark on dial *EN 837-1*

safetymark on dial *S*

accuracy class on dial *Cl.1.6*

Labelcode

Label WIKA standard

language of the label German