

10 9 8 7 6 5 4 3 2 1

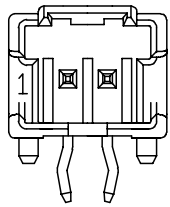

2 CIRCUIT

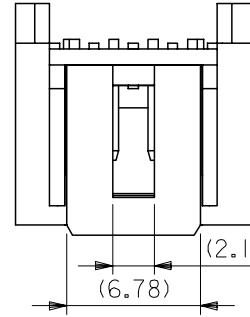
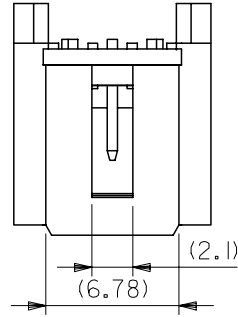
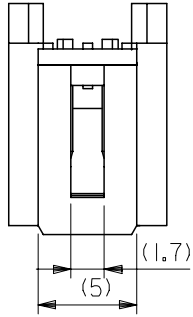
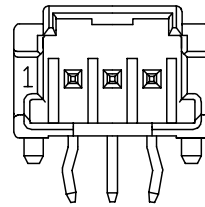
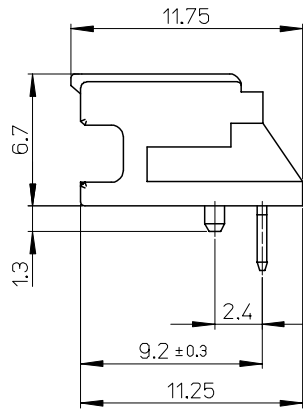

3 CIRCUIT

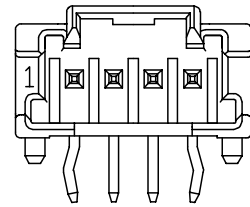

4 CIRCUIT

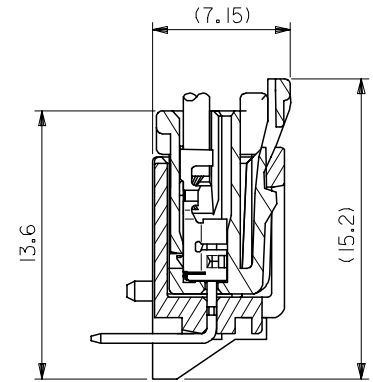

嵌合断面図

MODEL NO. : 55935-****

REVISED EC NO: J2007-1674 DRWN: NABEI 2006/12/11 CHKD: KTOYODA 2006/12/12 APPR: NUKITA 2006/12/13	GENERAL TOLERANCES (UNLESS SPECIFIED)		DIMENSION STYLE MM ONLY		SCALE ---	DESIGN UNIT'S METRIC	THIRD ANGLE PROJECTION	
	10 UNDER	± ---	DRAWN BY T. NIITSU		DATE '02/05/15		TITLE 2.0 W/B SINGLE CONN. PLUG HOUSING ASS'Y R/A -LEAD FREE-	
	10 ⁰ OVER 30 UNDER	± ---	CHECKED BY K. ASAKAWA		DATE '03/06/12			
	30 ⁰ OVER	± ---	APPROVED BY T. YAMAGUCHI		DATE '03/06/12		MOLEX INCORPORATED DOCUMENT NO. SD-55935-005 SHEET NO. 2 OF 2	
	ANGULAR	± --- °	MATERIAL NO.		SEE CHART			
DRAFT WHERE APPLICABLE MUST REMAIN WITHIN DIMENSIONS		SIZE A3		THIS DRAWING CONTAINS INFORMATION THAT IS PROPRIETARY TO MOLEX INCORPORATED AND SHOULD NOT BE USED WITHOUT WRITTEN PERMISSION				