



CIRCUIT BREAKER 3VA2 IEC FRAME 250 BREAKING CAPACITY CLASS M ICU=55KA @ 415 V 3POLE, LINE PROTECTION ETU320, LI, IN=250A OVERLOAD PROTECTION IR=100A ...250A SHORT CIRCUIT PROTECTION II=1,5...10 X IN BUSBAR CONNECTION

Model		
product brand name		SETRON
Product designation		Molded case circuit breaker
Design of the product		Line protection
Product variations		Selective Applications
Ground fault monitoring version		Without
Design of the operating mechanism		toggle handle
Type of the driving mechanism / motor drive		No
Design of the overcurrent release		ETU320

General technical data		
Number of poles		3
Trip class / of the L-trip / with I2t characteristic / initial value		0.5
Trip class / of the L-trip / with I2t characteristic / Full-scale value		15
Electrical endurance (switching cycles)		
• at AC-1 / at 380/415 V / at 50/60 Hz		10 000
Mechanical service life (switching cycles) / typical		20 000

Voltage		
Insulation voltage / Rated value	V	800
Protection class		
<b>Protection class IP</b>		IP40
Protection class IP / on the front		IP40
<b>Protective function of the overcurrent release</b>		LI
Switching capacity		
<b>Switching capacity class of the circuit breaker</b>		M
Dissipation		
<b>Active power loss</b>		
• maximum	W	48
Electricity		
<b>Continuous current / Rated value / maximum</b>	A	250
Continuous current / Rated value	A	250
Adjustable response value current / of the instantaneous short-circuit release / initial value	A	375
Main circuit		
<b>Operating voltage</b>		
• at AC / at 50/60 Hz / Rated value	V	690
<b>Operating current</b>		
• at 40 °C / Rated value	A	250
• at 50 °C / Rated value	A	250
• at 60 °C / Rated value	A	250
• at 65 °C / Rated value	A	250
• at 70 °C / Rated value	A	250
Auxiliary circuit		
<b>Number of NC contacts / for auxiliary contacts</b>		0
<b>Number of NO contacts / for auxiliary contacts</b>		0
Suitability		
<b>Suitability for use</b>		system protection
Adjustable parameters		
<b>Adjustable response value current</b>		
• of I-trip / Full-scale value	A	2 500
• for N-conductor protection / initial value	A	0
• for N-conductor protection / Full-scale value	A	0
<b>Adjustable response value current / of the current-dependent overload release / initial value</b>	A	100
Product details		
<b>Product component</b>		

• display		No
<b>Product property</b>		
• for neutral conductors / upgradeable/retrofitable / Short-circuit and overload proof		No
Product expansion / optional / motor drive		Yes

<b>Product function</b>		
<b>Product function</b>		
• Intrinsic device protection		Yes
• communication function		No
• other measurement function		No

<b>Short circuit</b>		
<b>Operational short-circuit current breaking capacity (Ics)</b>		
• at 240 V / Rated value	kA	85
• at 415 V / Rated value	kA	55
• at 440 V / Rated value	kA	55
• at 500 V / Rated value	kA	36
• at 690 V / Rated value	kA	3
<b>Maximum short-circuit current breaking capacity (Icu)</b>		
• at 240 V / Rated value	kA	85
• at 415 V / Rated value	kA	55
• at 440 V / Rated value	kA	55
• at 500 V / Rated value	kA	36
• at 690 V / Rated value	kA	3
<b>Short-circuit current making capacity (Icm)</b>		
• at 240 V / Rated value	kA	187
• at 415 V / Rated value	kA	121
• at 440 V / Rated value	kA	121
• at 500 V / Rated value	kA	75.6
• at 690 V / Rated value	kA	4.5

<b>Connections</b>		
Arrangement of electrical connectors / for main current circuit		Front terminal
Type of connectable conductor cross-section		
• for flat-bar terminal connection / minimum		13 x 1 mm
• for flat-bar terminal connection / maximum		25 x 8.5
Type of electrical connection / for main current circuit		Lug terminal

<b>Mechanical Design</b>		
<b>Height</b>	mm	181
<b>Width</b>	mm	105





Depth	mm	107
Mounting type		fixed mounting



### Environmental conditions

<b>Ambient temperature</b>		
• during operation / minimum	°C	-25
• during operation / maximum	°C	70
• during storage / minimum	°C	-40
• during storage / maximum	°C	80

### Certificates

<b>Equipment marking</b>		
• acc. to DIN EN 61346-2		Q
• acc. to DIN EN 81346-2		Q

General Product Approval	EMC	Declaration of Conformity	Test Certificates
 CCC	 VDE	 EAC	 EG-Konf.
	<a href="#">sonstig</a>		<a href="#">Typprüfbescheinigung/Werkszeugnis</a>

Shipping Approval	other
 DNV	 GL
 LRS	<a href="#">sonstig</a>

### Further information

- Information- and Downloadcenter (Catalogs, Brochures,...)**  
<http://www.siemens.com/lowvoltage/catalogs>
- Industry Mall (Online ordering system)**  
<https://eb.automation.siemens.com/mall/en/WW/Catalog/Product/3VA22255HL320AA0>
- Service&Support (Manuals, Certificates, Characteristics, FAQs,...)**  
<http://support.automation.siemens.com/WW/view/en/3VA22255HL320AA0/all>
- Image database (product images, 2D dimension drawings, 3D models, device circuit diagrams, ...)**  
[http://www.automation.siemens.com/bilddb/cax\\_en.aspx?mlfb=3VA22255HL320AA0](http://www.automation.siemens.com/bilddb/cax_en.aspx?mlfb=3VA22255HL320AA0)
- CAX-Online-Generator**  
<http://www.siemens.com/cax>
- Tender specifications**  
<http://ausschreibungstexte.siemens.com/tiplv>

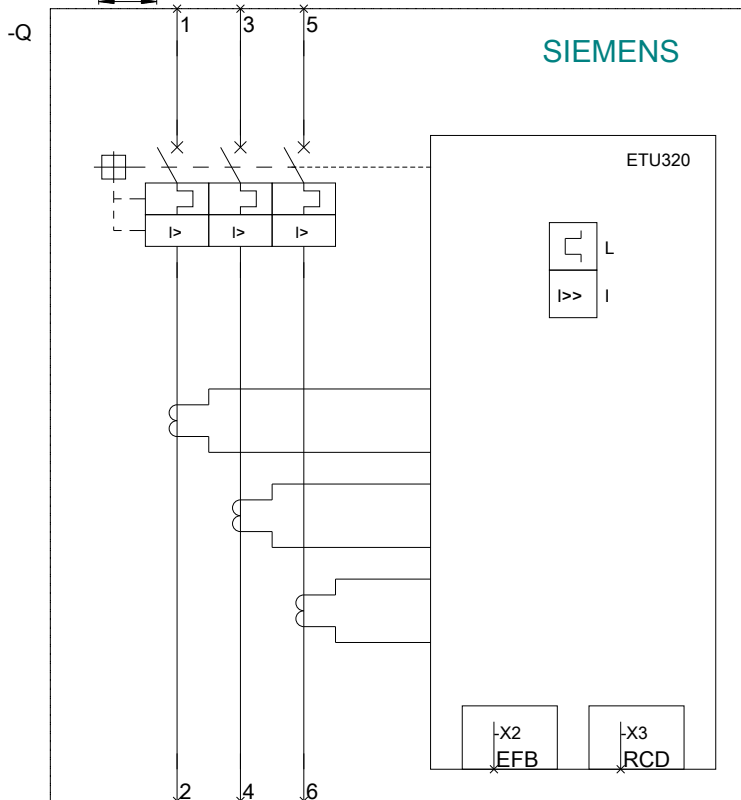
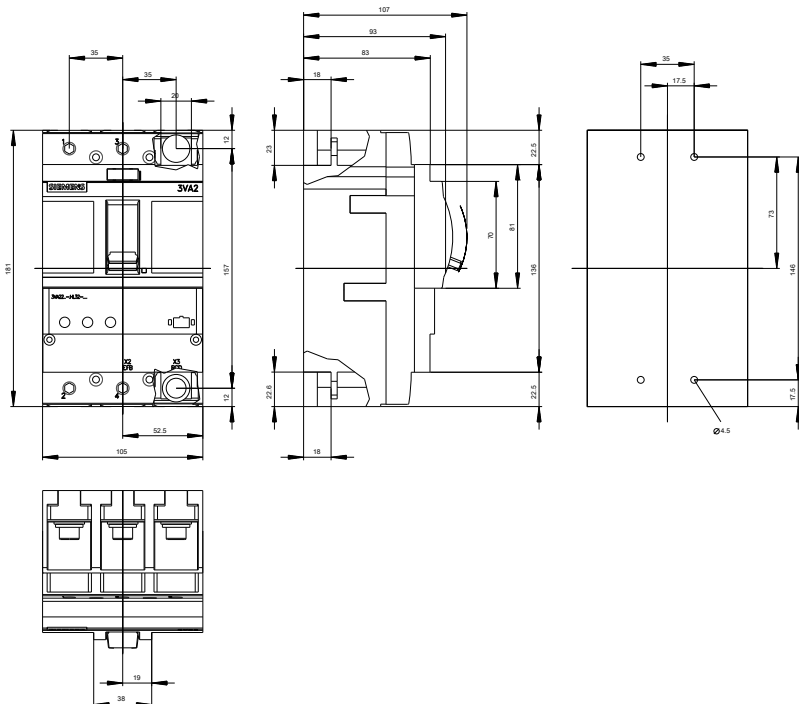

last modified:

20.07.2015