

Integrated signal lamp, single flash light, w. built-in electronic flash, green, 230 V AC, Diameter 70 mm



General technical data	
Product designation	Flashlight element
Consumed current maximum	35 mA
Type of voltage	AC
<ul style="list-style-type: none"> of the operating voltage 	
Operating voltage	
<ul style="list-style-type: none"> 1 at AC at 50 Hz rated value 1 at AC at 60 Hz rated value 	230 V 230 V
Relative positive tolerance of the operating voltage	10 %
Relative negative tolerance of the operating voltage	-10 %
Reference code	
<ul style="list-style-type: none"> acc. to DIN EN 81346-2 	P
Mounting type	Bayonet / flush mounting
Material	PC; PC/ABS; PA
Color	green
Mechanical data	
Product component Light source	Yes
Type of electrical connection	screw-type terminals

Outer diameter of the signal column element	75 mm
---	-------





Lamp

Design of the optical signal	flash light
Type of light source	Xenon gas discharge lamp
Light intensity	20 542 cd
Flash frequency	1 Hz
Number of flashes of light element	4 000 000

Ambient conditions

Ambient temperature during operation	-20 ... +50 °C
Protection class IP	IP65
Depth	31 mm
Height	66 mm
Width	75 mm

Certificates/ approvals

General Product Approval	EMC	Declaration of Conformity	other
 UL	 EAC	 RCM	 EG-Konf.
			Miscellaneous Confirmation

Further information

Information- and Downloadcenter (Catalogs, Brochures,...)
www.siemens.com/sirius/catalogs

Industry Mall (Online ordering system)
<https://mall.industry.siemens.com/mall/en/en/Catalog/product?mlfb=8WD5350-0CC>

Cax online generator
<http://support.automation.siemens.com/WW/CAXorder/default.aspx?lang=en&mlfb=8WD5350-0CC>

Service&Support (Manuals, Certificates, Characteristics, FAQs,...)
<https://support.industry.siemens.com/cs/ww/en/ps/8WD5350-0CC>

Image database (product images, 2D dimension drawings, 3D models, device circuit diagrams, EPLAN macros, ...)
http://www.automation.siemens.com/bilddb/cax_de.aspx?mlfb=8WD5350-0CC&lang=en

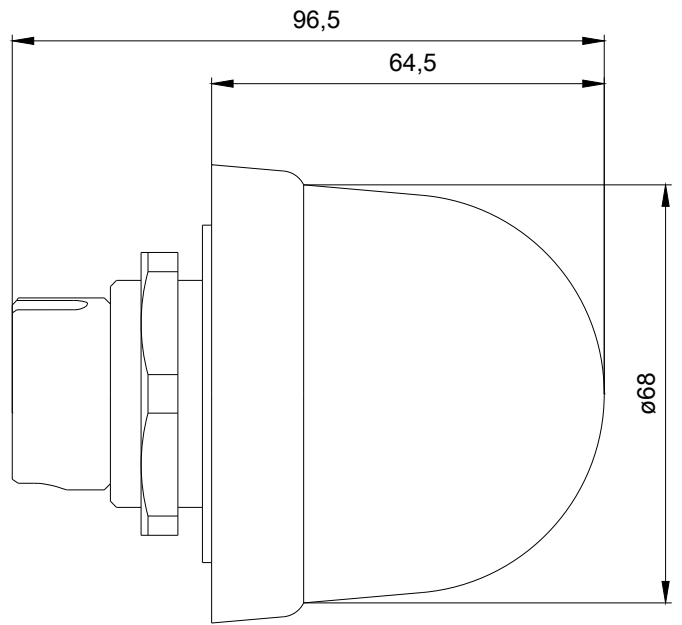
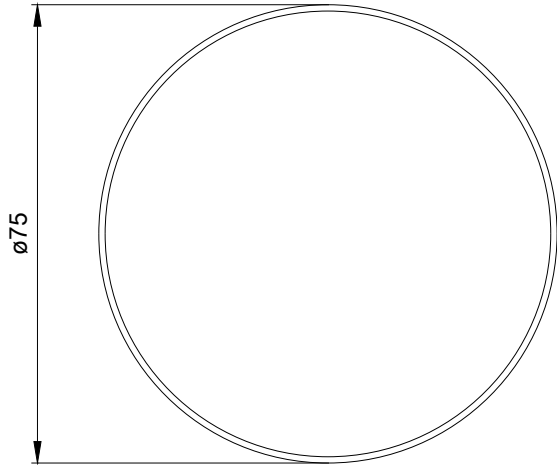

SIEMENS

last modified:

09/13/2019