



Brand of NTN Group

Technical data

US205-16G2

Insert bearings



Spherical outer diameter, fixing by socket set screw, single lip seal

VISUAL (S)

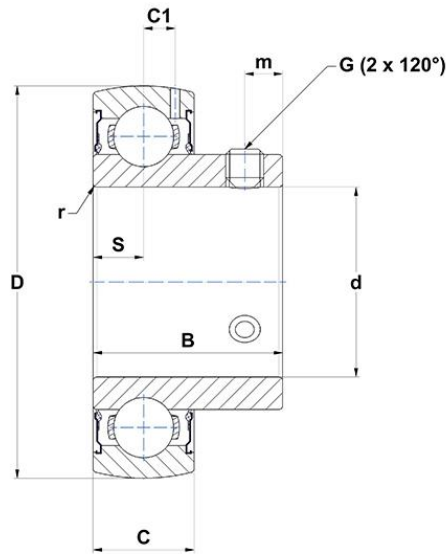

PRODUCT DEFINITION

Brand	SNR
B - Width of Inner Ring	27 mm
C - Width of Outer Ring	15 mm
C1 - Distance center of OR to center of lubrication zone	4,3 mm
d - Shaft diameter	25,4 mm
D - Outer diameter of OR	52 mm
G - Set screw size	1/4-28UNF
m - Distance to set screw	5,5 mm



NTN Europe

1 rue des Usines · BP 2017 · 74010 Annecy Cedex · France · Tel. +33 (0)4 50 65 30 00
S.A. au capital de 322 639 919 € · RCS ANNECY B 325 821 072 · Id. Fiscale : FR 48 325 821 072
SIRET 325 821 072 00015 · Code APE 2815 Z · Code NACE 28.15

PRODUCT DEFINITION

r - Radius Inner Ring	0.6
S - Distance front side/bearing centre	7,5 mm
f0 - Factor	14
SW - Wrench size	3,175 mm

PRODUCT PERFORMANCE

C - Dynamic load rating	14000000 mN
C0 - Static load rating	7880000 mN
Operating temperature min.	253,15 °K
Operating temperature max.	373,15 °K

OTHER FEATURES

Mass	0,16 kg
Recommended tightening torque for set screw	3.7 N-m

BEARING FREQUENCIES

BPFO - Over rolling frequency on outer ring (60 rpm)	3.58178020565553 Hz
BPFI - Over rolling frequency on inner (60 rpm)	5.41821979434447 Hz
BSF - Over rolling frequency on rolling element (60 rpm)	4.69673855838714 Hz
BRF - Rotational frequency - rolling element (60 rpm)	2.34836927919357 Hz
FTF - Rotational frequency - cage (60 rpm)	0.39797557840617 Hz

