

CLÉS À PIPE

CLÉS À PIPE DÉBOUCHÉES OGV®

Profil OGV® FACOM

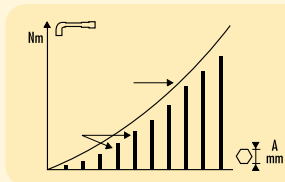
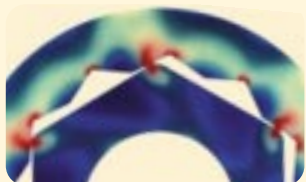

- Profil OGV® FACOM 6 pans et 12 pans. Les surfaces de contact sont augmentées et les contraintes réduites.
- Augmentation du couple de serrage.
- Longévité de l'outil accrue.
- Protection des angles de l'écrou.

Déboilage spécifique et poinçonnage profond

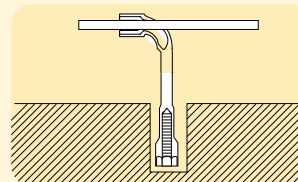
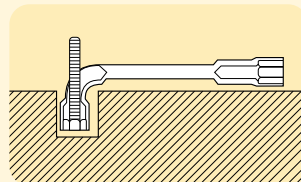

Coudage et déboilage spécifiques : la possibilité de passage d'une tige filetée ou d'une broche ne nuit pas à la résistance de la clé. Poinçonnage profond dans les douilles : serrage possible même en cas de dépassement de la tige filetée.

75 Clés à pipe débouchées OGV® forgées 6 pans x 6 pans métriques et en pouces

▷ ISO 2236, NF E 74-303

76 Clés "à pipe" débouchées OGV® forgées 12 pans x 6 pans métriques

▷ ISO 2236, NF E 74-303

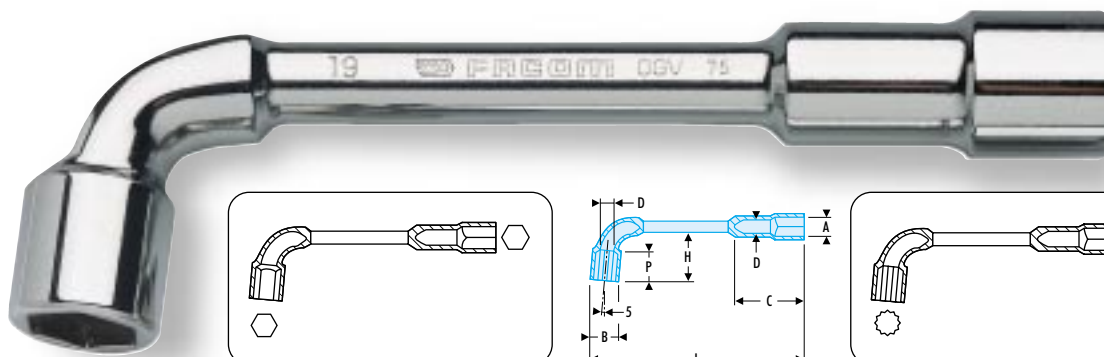

➤	➤	B	C	P	D	H	L	ΔΔ
A mm	A"	mm	mm	mm	mm	mm	mm	g
75.6	75.1/4	10,0	21	7	5,0	15	102	32
75.7		11,0	22	8	5,0	17	106	35
75.8	75.5/16	12,5	25	9	7,0	19	114	60
75.9		13,5	26	10	7,0	20	122	65
75.10	75.3/8	15,0	28	11	8,0	24	129	95
75.11	75.7/16	16,5	30	12	8,0	25	136	114
75.12		18,0	36	12	9,0	28	144	152
75.13	75.1/2	19,5	38	13	9,0	30	152	175
75.14		21,0	40	14	10,5	32	160	202
75.15	75.9/16	22,5	42	15	10,5	34	169	226
75.16	75.5/8	24,0	46	17	13,0	37	178	285
75.17		25,5	48	18	13,0	39	187	312
75.18	75.11/16	26,5	50	19	13,0	40	195	365
75.19	75.3/4	28,5	51	20	15,0	41	204	430
75.20		29,5	53	21	15,0	43	212	440
75.21	75.13/16	30,5	55	22	15,0	46	221	490
75.22		32,0	57	23	15,0	48	230	536
75.23	75.7/8	33,5	64	24	18,0	51	240	626
75.24	75.15/16	34,5	67	25	18,0	54	250	660
75.25		36,0	69	26	20,0	56	260	785
75.26	75.1"	37,0	70	27	20,0	57	270	795
75.27		38,5	73	28	22,0	58	280	950
75.28		39,5	75	29	22,0	60	290	950
75.29	75.1 1/8	41,0	76	30	22,0	62	300	1050
75.30		42,0	83	31	24,0	64	310	1300
75.31		43,5	86	31	24,0	70	320	1385
75.32	75.1 1/4	44,5	88	32	24,0	74	330	1400
75.33		46,0	92	33	27,0	79	340	1480
75.34		47,5	95	34	27,0	80	350	1550
75.35		48,5	96	35	27,0	81	360	1630
75.36		49,5	97	36	27,0	82	370	1700
75.38		52,0	99	38	28,0	85	390	2080

➤	B	C	P	D	H	L	ΔΔ
A mm	mm	mm	mm	mm	mm	mm	g
76.6	10,0	23	7	5,0	16	102	32
76.7	11,0	24	8	5,0	17	106	41
76.8	12,5	27	9	7,0	19	114	60
76.9	13,5	28	10	7,0	20	122	65
76.10	15,0	30	11	8,0	24	129	95
76.11	16,5	32	12	8,0	25	136	114
76.12	18,0	38	12	9,0	28	144	152
76.13	19,5	40	13	9,0	30	152	175
76.14	21,0	42	14	10,5	32	160	200
76.15	22,5	44	15	10,5	34	169	225
76.16	24,0	49	17	13,0	37	178	285
76.17	25,5	51	18	13,0	39	187	312
76.18	26,5	53	19	13,0	40	195	365
76.19	28,5	54	20	15,0	41	204	430
76.20	29,5	56	21	15,0	43	212	440
76.21	30,5	58	22	15,0	46	221	490
76.22	32,0	60	23	15,0	48	230	536
76.23	33,5	67	24	18,0	51	240	625
76.24	34,5	70	25	18,0	54	250	660
76.25	36,0	72	26	20,0	56	260	785
76.26	37,0	73	27	20,0	57	270	795
76.27	38,0	77	28	22,0	58	280	950
76.28	39,5	79	29	22,0	60	290	950
76.29	41,0	80	30	22,0	62	300	1050
76.30	42,0	87	31	24,0	64	310	1300
76.31	43,5	90	31	24,0	70	320	1385
76.32	44,5	92	32	24,0	74	330	1400
76.33	46,0	96	33	27,0	79	340	1480
76.34	47,0	99	34	27,0	80	350	1550
76.35	48,5	100	35	27,0	81	360	1630
76.36	49,5	101	36	27,0	82	370	1700
76.38	52,0	103	38	28,0	85	390	2080



75 et 76 Jeux de clés à pipe

• Présentation : en boîte ou sur panneau.

75.JE9



75.JE16

REF	PROFIL	PROFIL	Ø _{ext} mm/°	ΔΔ kg
75.JN8	•		8-10-11-13-17-19-22-24	2,370
75.JE9	•		8-9-10-11-12-13-14-17-19	1,420
75.JN10	•		8-10-11-12-13-14-16-17-18-19	2,160
75.JE12	•		7-8-10-11-12-13-14-16-17-18-19-21	2,680
75.JE16	•		8-9-10-11-12-13-14-15-16-17-18-19-21-22-23-24	4,700
75.JU10	•		5/16-3/8-7/16-1/2-9/16-5/8-11/16-3/4-13/16-7/8	2,760
76.JN8	•		8-10-11-13-17-19-22-24	2,370
76.JE9	•		8-9-10-11-12-13-14-17-19	1,420
76.JN10	•		8-10-11-12-13-14-16-17-18-19	2,160
76.JE12	•		7-8-10-11-12-13-14-16-17-18-19-21	2,680
76.JE16	•		8-9-10-11-12-13-14-15-16-17-18-19-21-22-23-24	4,700
75.P22M	•		8-9-10-11-12-13-14-15-16-17-18-19-21-22-23-24-26-27-28-29-30-32	13,340
76.P22M	•		8-9-10-11-12-13-14-15-16-17-18-19-21-22-23-24-26-27-28-29-30-32	13,340

SÉRIE NERVUS

92 Clés en tube "nervus"

▷ ISO 2236, NF E 74-303

- Permet le travail sur des tiges filetées longues.
- Coude nervuré pour une résistance supérieure.
- Présentation : chromé.

REF	B	C	D	L	ΔΔ
A mm	mm	mm	mm	mm	g
92.4	7,0	24	18	79	14
92.5	8,0	26	19	81	19
92.5,5	9,3	27	19	82	21,5
92.6	10,7	28	19	83	25
92.7	12,1	30	19	86	34
92.8	13,3	32	21	90	42
92.9	14,8	34	21	95	50
92.10	16,0	36	22	104	62
92.11	17,4	38	23	106	72
92.12	18,8	40	24	114	93
92.13	20,3	42	24	119	107
92.14	20,1	44	25	121	113
92.15	21,4	46	27	127	137
92.16	22,7	48	28	130	154
92.17	24,0	50	28	135	169
92.18	25,4	52	29	140	206
92.19	26,7	55	30	145	231
92.20	28,0	58	32	150	252
92.21	29,4	61	34	155	287
92.22	30,7	64	36	160	319
92.23	32,0	67	38	165	341
92.24	33,4	70	40	170	380
92.26	36,0	76	44	181	452
92.27	37,3	80	47	187	521
92.29	40,0	88	52	196	594
92.30	41,3	92	55	201	650
92.32	44,0	100	61	210	753

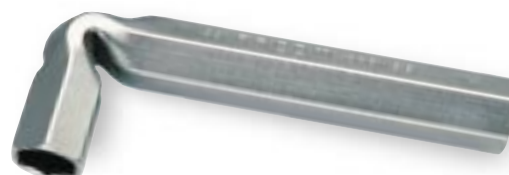
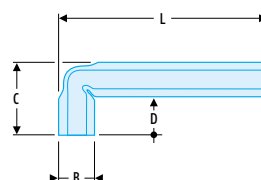

92.P16M

92 Jeux de clés

• Présentation : en boîte ou sur stand.

REF	PROFIL	PROFIL	Ø _{ext} mm	ΔΔ kg
92.JE8	•		8-10-11-13-17-19-22-24	1,375
92.P8M	•		8-10-11-13-17-19-22-24	1,770
92.P16M	•		8-9-10-11-12-13-14-15-16-17-18-19-21-22-23-24	3,700

CLÉS À BÉQUILLES

91 Clés en tube droites

▷ ISO 2236, DIN 896, NF E 74-303

- 2 ouvertures par clé.
- Utilisation avec la broche réf. 160.
- Présentation : chromé.

➤	B x B'	L	ΔΔ	Broche à utiliser
A mm	mm	mm	g	
91.6X7	9,6 x 11,0	85	21	160.8
91.8X9	12,3 x 13,6	91	33	160.6
91.10X11	14,9 x 16,2	97	46	160.6
91.12X13	17,5 x 18,8	103	66	160.6
91.14X15	20,1 x 21,4	110	84	160.8
91.16X17	22,7 x 24,0	117	108	160.8
91.18X19	25,4 x 26,7	125	144	160.8
91.20X21	28,0 x 29,4	133	173	160.10
91.22X23	30,7 x 32,0	141	215	160.10
91.24X25	33,4 x 34,7	150	262	160.10
91.26X27	36,0 x 37,3	159	312	160.10
91.28X29	38,7 x 40,0	168	381	160.12
91.30X31	41,3 x 42,7	177	444	160.12
91.32X34	44,0 x 46,6	190	505	160.12

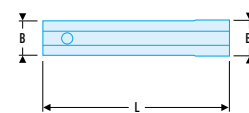
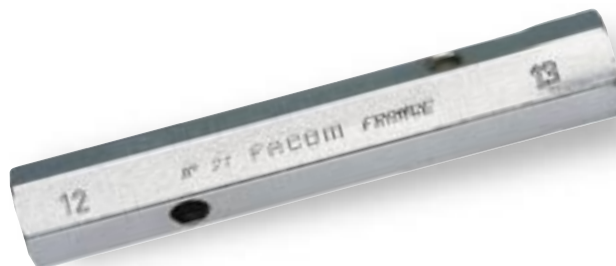

91 Jeux de clés

- Présentation : en boîte ou sur stand.

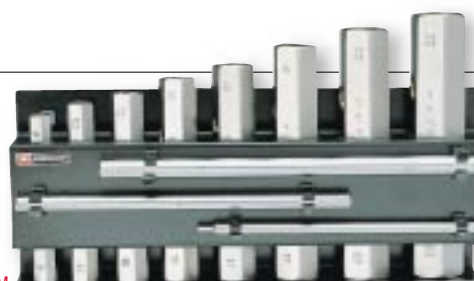

91.P8M

➤	mm	ΔΔ	Broches
	mm	kg	➤
91.JE8	8x9-10x11-12x13-14x15-16x17-18x19-20x21-22x23	1,100	160.6-160.8-160.10
91.P8M	8x9-10x11-12x13-14x15-16x17-18x19-20x21-22x23	1,510	160.6-160.8-160.10

97 Clés à béquilles doubles forgées

▷ ISO 2236, DIN 896, NF E 74-303

- 2 ouvertures par clé.
- Débouchage complet de la clé permettant le passage de tiges filetées très longues.
- Utilisation avec broches réf. 160.
- Têtes 6 pans, corps hexagonal.

➤	D1 x D2	L	ΔΔ	Broche à utiliser	Ø
	mm	mm	g		mm
97.6X7	9,5 x 10,7	110	32	160.8	4,0
97.8X9	12,5 x 14,0	120	48	160.8	4,0
97.10X11	15,0 x 16,0	130	66	160.6	6,0
97.12X13	17,5 x 19,0	140	106	160.6	6,0
97.14X15	20,0 x 21,5	150	138	160.6	6,5
97.16X17	22,7 x 24,0	160	188	160.8	8,2
97.18X19	25,2 x 26,5	170	238	160.8	8,2
97.20X22	27,7 x 30,2	180	262	160.10	10,2
97.21X23	29,0 x 31,2	185	294	160.10	10,2
97.24X26	33,0 x 35,5	190	416	160.12	12,5
97.25X28	34,5 x 38,0	195	442	160.12	12,5
97.27X29	37,0 x 39,5	200	504	160.12	12,5
97.30X32	40,5 x 43,0	200	630	160.12	12,5

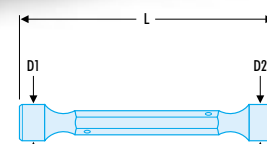

160 Broches pour clé 91 et clé 97

- Acier au chrome traité.
- Présentation : chromé.



➤	D	L	ΔΔ
	mm	mm	g
160.6	3-6	150	30
160.8	4-8	174	70
160.10	10	200	123
160.12	12	250	220

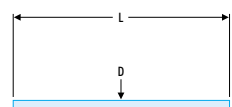

97.JE6

97 Jeu de 6 clés à béquilles doubles forgées

- Dimensions métriques de 8 à 19 mm : 8 x 9, 10 x 11, 12 x 13, 14 x 15, 16 x 17, 18 x 19 mm.
- ΔΔ 770 g.