

REV	Description	Date
A00	First Issue	2015-MAY-20

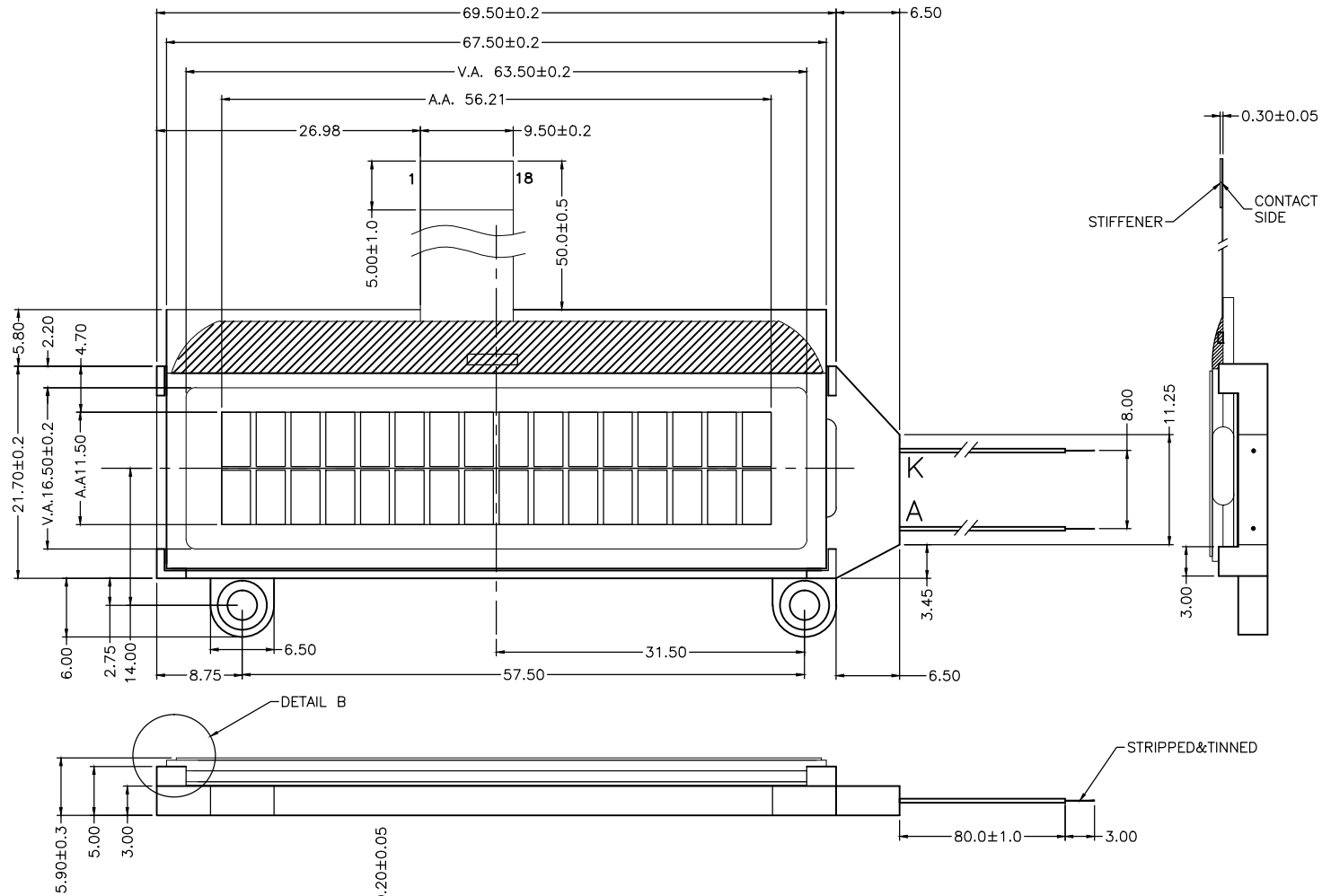

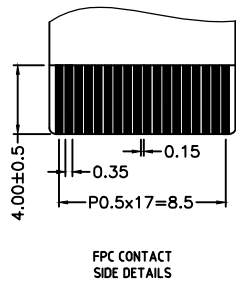
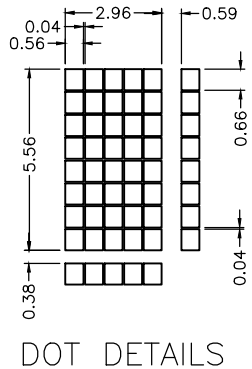
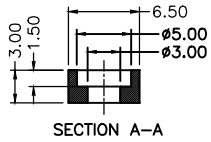

PIN ASSIGNMENT:

1	RSTB
2	A0
3	CSB
4	RW
5	E
6	DB0
7	DB1
8	DB2
9	DB3
10	DB4
11	DB5
12	DB6
13	DB7
14	VSS
15	VDD
16	VG
17	V0
18	XV0
A	LED+
K	LED-

SPECIFICATIONS:

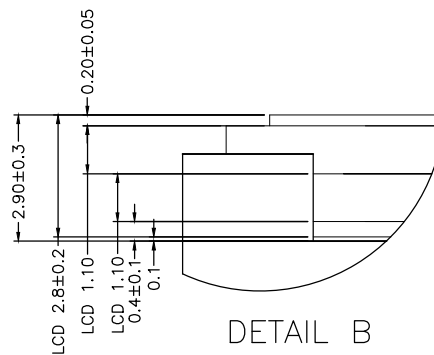
- 1) FSTN/-VE/TRANSMISSIVE MODE
- 2) 1/16 DUTY, 1/5 BIAS, VLCD=4.5V
- 3) VIEWING ANGLE=12 O'CLOCK
- 4) OP.TEMP.= -20 °C TO °C+70
ST.TEMP.= -30 °C TO °C+80
- 5) WITH PURE GREEN LED BACKLIGHT, 3.3V@15mA
- 6) DRIVER: ST7032S, VDD=2.7 ~ 3.45V

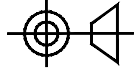

Description: MECHANICAL SPECIFICATIONS	
Scale:	 TRI-T COMPANY LIMITED
Sheet : 1 of 1	
Unspecified Tol. ±0.3	Unit mm
Approvals	Date
Draw:	Project Number CI064-4001-33
Check:	Item Number
Approve:	Do Not Scale This Drawing
 Projection	