

Features

- Light Weight
- Low Friction
- Clean Design
- Adjustable Cushion
- Long Lasting Quality
- Aluminium Piston
- ISO 15552 / 6431

RS PRO Pneumatic Piston Rod Cylinder

RS Stock No: 0711567

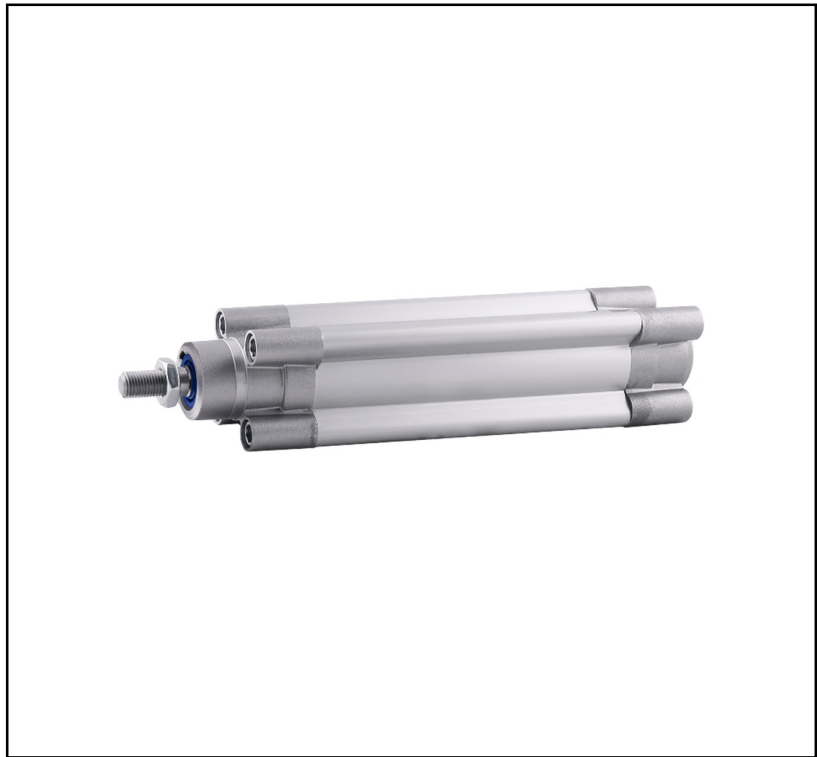

RS PRO is the own brand of RS. The RS PRO Seal of Approval is your assurance of professional quality, a guarantee that every part is rigorously tested, inspected, and audited against demanding standards. Making RS PRO the Smart Choice for our customers.

Product Description

Main advantages

- International Standards Conformity
- PU seal low friction and long lasting
- Wide range
- Wide selection of materials

Applications

- Pneumatic Automation, Robotics, Handling
- Automotive Process
- Textile, Packaging, Heavy Duty
- Food Process

Fluid Compatibility:

- Filtered and lubricated compressed air as well as non-lubricated air.

Specifications & Drawings

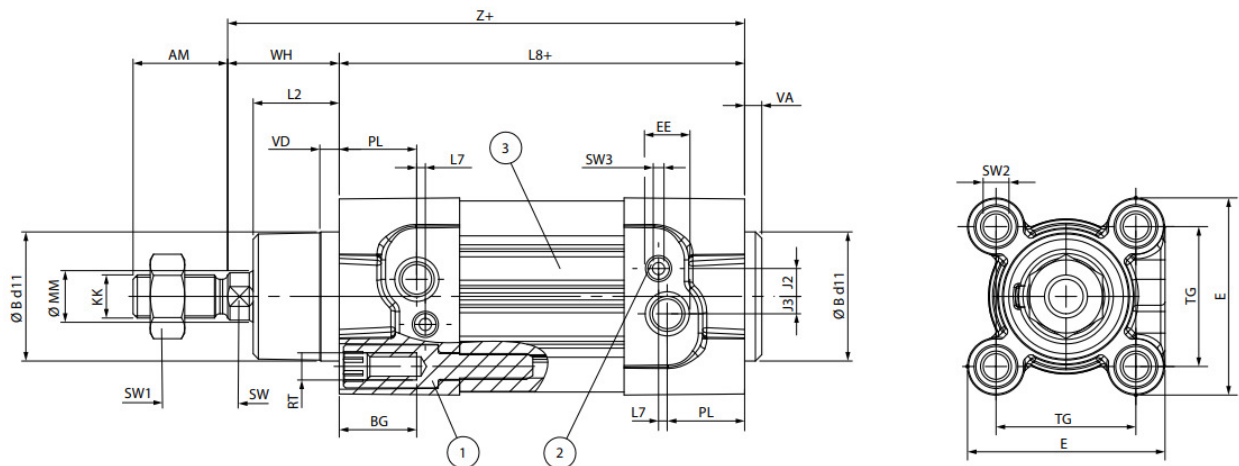

Specifications

Manufacturing Series	RS PRO L Series
Action	Double acting cushioned magnetic
Bore Ø (mm)	63
Stroke (mm)	80
Length (Z+AM) (mm)	190
Piston Rod Thread Gender	Male
Maximum Operating Pressure	10 Bar
Absolute Maximum Pressure	10 Bar
Working Pressure Range	1-10 Bar
Working Temperature Range	-20 °C to +80 °C
Cushioning Type	Magnetic
ØB d11 (mm)	45
VD (mm)	15
VA (mm)	4
L2 (mm)	29
WH (mm)	37
Ø MM (mm)	20
SW (mm)	17
KK (mm)	M16X 1.5
AM (mm)	32
SW1 (mm)	22
Z (mm)	158
L8 (mm)	121
BG (mm)	20
RT	M8
SW2 (mm)	8
E (mm)	74
TG (mm)	56.5
EE	G 3/8
PL (mm)	22
J3 (mm)	11
J2 (mm)	8.5
L7 (mm)	4
SW3 (mm)	4



CARATTERISTICHE TECNICHE
 TECHNICAL CHARACTERISTICS
 TECHNISCHE ANGABEN
 CARACTÉRISTIQUES TECHNIQUES
 CARACTERÍSTICAS TÉCNICAS
 CARACTERÍSTICAS TÉCNICAS

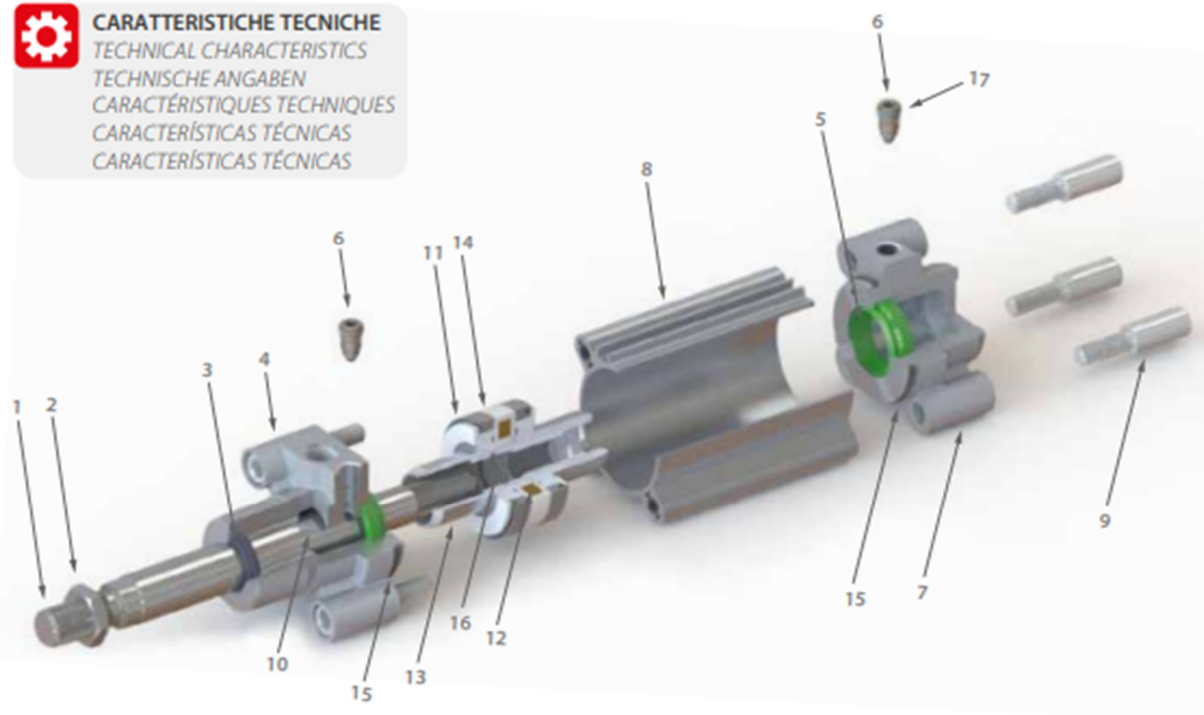

Materiali e Componenti / Standard **IT**

- 1 Asta pistone acciaio C40 Cromato
- 2 Dado in acciaio zincato
- 3 Guarnizione asta in PU
- 4 Testata anteriore in alluminio
- 5 Guarnizioni ammortizzo in NBR
- 6 Spillo ammortizzatore in Acciaio zincato
- 7 Testata posteriore in alluminio
- 8 Camicia cilindro in alluminio anodizzato
- 9 Vite di fissaggio in Acciaio zincato
- 10 Boccola KU
- 11 Guarnizioni pistone in NBR
- 12 Magnete in plastroferite
- 13 Pistone in alluminio
- 14 Fascia guida
- 15 O-Ring in NBR (Testata Anteriore)
- 16 O-Ring in NBR (Pistone)
- 17 O-Ring in NBR (Vite Ammortizzo)

Component Parts and Materials / Standard **GB**

- 1 Chrome-plated Steel C40 piston rod
- 2 Zinc-plated steel nut
- 3 PU rod seal
- 4 Aluminium front head
- 5 NBR cushion seal
- 6 Zinc-plated steel cushion screw
- 7 Aluminium rear head
- 8 Anodized Aluminium cylinder profile
- 9 Zinc-plated screw
- 10 KU bushing
- 11 NBR piston seals
- 12 Plastroferite magnet
- 13 Aluminium piston
- 14 Guide
- 15 NBR O-Ring (front head)
- 16 NBR O-Ring (piston)
- 17 NBR O-Ring (cushion screw)

Komponenten und Materialien / Standard **DE**

- 1 Kolbenstange Stahl C40 verchromt
- 2 Stahlmutter verzinkt
- 3 Kolbenstangendichtung aus PU
- 4 Zylinderkopf Aluminium
- 5 Dämpfungsdichtung aus NBR
- 6 Dämpfungsschraube Stahl verzinkt
- 7 Zylinderdeckel Aluminium
- 8 Zylinderrohr Aluminium eloxiert
- 9 Flanschschrauben Stahl verzinkt
- 10 Deckel KU
- 11 Kolbendichtung aus Polyurethan oder NBR
- 12 Magnetring Plastroferit
- 13 Kolbenflansch Aluminium
- 14 Führung
- 15 O-Ring Dichtung aus NBR (Zylinderkopf)
- 16 O-Ring Dichtung aus NBR (Kolben)
- 17 O-Ring Dichtung aus NBR (Dämpfungsschraube)

Matériaux et Composants / Standard **FR**

- 1 Tige de piston en acier chromé C40
- 2 Ecrou en acier galvanisé
- 3 Joint de tige en PU
- 4 Flaque avant en aluminium
- 5 Joint d'amortisseur en NBR
- 6 Vis de réglage d'amortisseur en acier galvanisé
- 7 Flaque arrière en aluminium
- 8 Corps en aluminium anodisé
- 9 Vis en acier galvanisé
- 10 Buche KU
- 11 Joint de piston en polyuréthane ou NBR
- 12 Aimants en plastroferite
- 13 Piston en aluminium
- 14 Bande de guidage ou Guide
- 15 Joint torique en NBR (Flaque)
- 16 Joint torique en NBR (Piston)
- 17 Joint torique en NBR (Vis de réglage d'amortisseur)

Materiales y componentes / Standard **ES**

- 1 Vástago pistón acero C40 Cromado
- 2 Tuerca en acero zincado
- 3 Junta vástago en PU
- 4 Tapa anterior en aluminio
- 5 Junta de amortiguación en NBR
- 6 Tornillo de amortiguación en Acero zincado
- 7 Tapa posterior en aluminio
- 8 Camisa cilindro en aluminio anodizado
- 9 Tornillos de fijación en Acero zincado
- 10 Cojinete KU
- 11 Juntas pistón en poliuretano o NBR
- 12 Magnete en plastroferita
- 13 Pistón en aluminio
- 14 Guía
- 15 Junta tórica en NBR (Tapa anterior)
- 16 Junta tórica en NBR (Pistón)
- 17 Junta tórica en NBR (Tornillos amortiguación)

Materiais e Componentes / Standard **PT**

- 1 Haste do cilindro em Aço C40 Cromado
- 2 Porca em aço zincado
- 3 Vedação da haste em PU
- 4 Cabeçote frontal em alumínio
- 5 Vedação do amortecimento em NBR
- 6 Parafuso de Regulação do Amortecimento em Aço Zincado
- 7 Cabeçote traseiro em alumínio
- 8 Camisa do cilindro em alumínio anodizado
- 9 Parafusos de fixação em Aço Zincado
- 10 Bucha KU
- 11 Vedação do êmbolo em poliuretano ou NBR
- 12 Ímã em plastroferite
- 13 Êmbolo em alumínio
- 14 Guia e protetor do magnético
- 15 O-ring em NBR (Cabeçote frontal)
- 16 O-ring em NBR (Êmbolo)
- 17 O-ring em NBR (Parafuso do amortecimento)



Fluidi compatibili

Aria compressa filtrata lubrificata e non lubrificata.

Fluids

Filtered and lubricated compressed air as well as non lubricated air.

Geeignete Medien

Gefilterte geölte und nicht geölte Druckluft.

Fluides compatibles

Air comprimé filtré, lubrifié ou non lubrifié.

Fluidos compatibles

Aire comprimido filtrado e lubricado y no lubricado.

Fluidos compatíveis

Air comprimido filtrado e lubrificado ou não lubrificado.

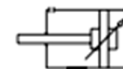

Alesaggi

Bores

Durchmesser

Diamètres

Diámetros

Diâmetros

32 - 40 - 50 - 63 - 80 - 100 - 125 mm



Funzionamento

Semplice effetto magnetico o non magnetico. Doppio effetto ammortizzato magnetico o non magnetico, stelo singolo o passante. Tandem.

Functioning

Single acting magnetic or non-magnetic. Double cushioned acting single or double end rod, magnetic or non-magnetic. Tandem.

Funktion

Einfachwirkend magnetisch oder nicht magnetisch. Doppeltwirkend einseitig oder durchgehende Kolbenstange, magnetisch oder nicht magnetisch, gedämpft. Tandemzylinder.

Exécutions

Simple effet Magnétique ou non-Magnétique. Double effet Magnétique ou non-Magnétique, tige de piston simple ou traversante. Amortisseur Tandem.

Funcionamiento

Simple efecto magnético o no magnético. Doble efecto amortiguado magnético o no magnético vástago simple o pasante. Tandem.

Funcionamento

Simple ação magnética ou não-magnética. Dupla ação com amortecimento, magnético ou não-magnética, haste simples ou passante. Tandem.



Temperature NBR

Temperatures NBR

Temperatur NBR

Températures NBR

Temperaturas NBR

Temperaturas NBR

0 °C (-20 °C con aria secca)

(-20 °C with dry air)

(-20 °C mit trockener Luft)

(-20 °C avec air sec)

(-20 °C con aire seco)

(-20 °C com ar seco)

+ 80 °C



Corse Standard

Standard Strokes

Standardhub

Courses standards

Carreras Standard

Cursos Padrão

from 25 to 1000 mm

Corse a richiesta: fino a 2700 mm

Strokes on Demand: Up to 2700 mm

Auf Anfrage: Bis 2700 mm

Course sur demande: Jusqu'à 2700 mm

Carreras bajo Demanda: Hasta 2700 mm

Cursos sob encomenda: Até 2700 mm



Pressioni

Pressures

Druckbereich

Pressions

Presiones

Pressões

1 bar (0.1 MPa)

10 bar (1 MPa)

Pressione di spunto: 0,3 bar (0.03 MPa)

Starting pressure: 0,3 bar (0.03 MPa)

Schaumdruck: 0,3 bar (0.03 MPa)

Pression de démarrage: 0,3 bar (0.03 MPa)

Presión de arranque: 0,3 bar (0.03 MPa)

Pressão de partida: 0,3 bar (0.03 MPa)



Sensori consigliati

Sensors recommended

Empfohlene Sensoren

Capteurs recommandés

Sensores recomendados

Sensores aconselhados

DT

Approvals

Declarations	MFR Declaration of Conformity
Standards Met	ISO 15552 / 6431