

The contents of this publication are the copyright of the publisher and may not be reproduced (even extracts) unless prior written permission is granted. Every care has been taken to ensure the accuracy of the information contained in this publication but no liability can be accepted for any loss or damage whether direct, indirect or consequential arising out of the use of the information contained herein.

Le contenu de cette publication est soumis au copyright de l'éditeur et sa reproduction, même partielle, est interdite sans autorisation écrite préalable. Le plus grand soin a été apporté à l'exactitude des informations données dans cette publication mais SKF décline toute responsabilité pour les pertes ou dommages directs ou indirects découlant de l'utilisation du contenu du présent document.

Nachdruck, auch auszugsweise, nur mit unserer vorherigen schriftlichen Genehmigung gestattet. Die Angaben in dieser Druckschrift wurden mit größter Sorgfalt auf ihre Richtigkeit hin überprüft. Trotzdem kann keine Haftung für Verluste oder Schäden irgendwelcher Art übernommen werden, die sich mittelbar oder unmittelbar aus der Verwendung der hier enthaltenen Informationen ergeben.

El contenido de esta publicación es propiedad de los editores y no puede reproducirse (incluso parcialmente) sin autorización previa por escrito. Se ha tenido el máximo cuidado para garantizar la exactitud de la información contenida en esta publicación, pero no se acepta ninguna responsabilidad por pérdidas o daños, ya sean directos, indirectos o consecuentes, que se produzcan como resultado del uso de dicha información.

La riproduzione, anche parziale, del contenuto di questa pubblicazione è consentita soltanto previa autorizzazione scritta della SKF. Nella stesura è stata dedicata la massima attenzione al fine di assicurare l'accuratezza dei dati, tuttavia non si possono accettare responsabilità per eventuali errori od omissioni, nonché per danni o perdite diretti o indiretti derivanti dall'uso delle informazioni qui contenute.

O conteúdo desta publicação é de direito autoral do editor e não pode ser reproduzido (nem mesmo parcialmente), a não ser com permissão prévia por escrito. Todo cuidado foi tomado para assegurar a precisão das informações contidas nesta publicação, mas nenhuma responsabilidade pode ser aceita por qualquer perda ou dano, seja direto, indireto ou consequente como resultado do uso das informações aqui contidas.

本出版物内容的著作权归出版者所有且未经事先书面许可不得被复制（甚至引用）。我们已采取了一切注意措施以确定本出版物包含的信息准确无误，但我们不对因使用此等信息而产生的任何损失或损害承担任何责任，不论此等责任是直接、间接或附随性的。

Содержание этой публикации является собственностью издателя и не может быть воспроизведено (даже частично) без предварительного письменного разрешения. Несмотря на то, что были приняты все меры по обеспечению точности информации, содержащейся в настоящем издании, издатель не несет ответственности за любой ущерб, прямой или косвенный, вытекающий из использования вышеуказанной информации.



skf.com | mapro.skf.com | skf.com/mount

© SKF is a registered trademark of the SKF Group.

© SKF Group 2021

MP5260 · 2021/02

SKF TMFT 36



Instructions for use
Mode d'emploi
Bedienungsanleitung
Instrucciones de uso

Manuale d'istruzioni
Instruções de uso
使用说明书
Инструкция по эксплуатации

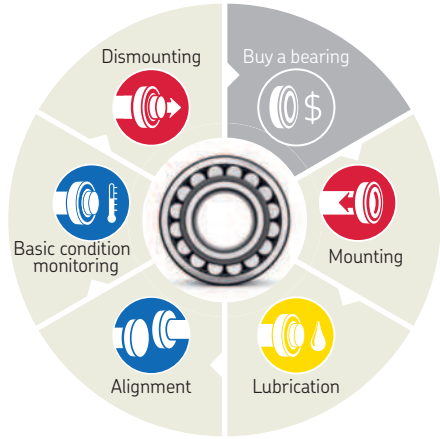

TMFT 36

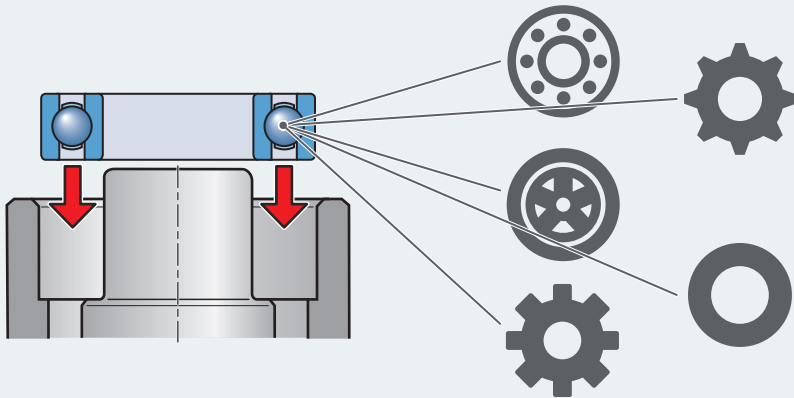
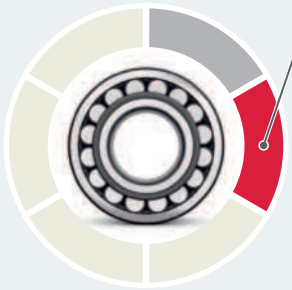

TMFT 36 A..



- A10-26 TMFT 36 A10-26
- A10-30 TMFT 36 A10-30
- A10-35 TMFT 36 A10-35
- A12-28 TMFT 36 A12-28
- A12-32 TMFT 36 A12-32
- A12-37 TMFT 36 A12-37
- A15-32 TMFT 36 A15-32
- A15-35 TMFT 36 A15-35
- A15-42 TMFT 36 A15-42
- A17-35 TMFT 36 A17-35
- A17-40 TMFT 36 A17-40
- A17-47 TMFT 36 A17-47

TMFT 36 B..

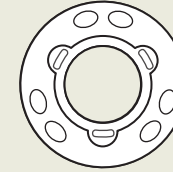

- B20-42 TMFT 36 B20-42
- B20-47 TMFT 36 B20-47
- B20-52 TMFT 36 B20-52
- B25-47 TMFT 36 B25-47
- B25-52 TMFT 36 B25-52
- B25-62 TMFT 36 B25-62
- B30-55 TMFT 36 B30-55
- B30-62 TMFT 36 B30-62
- B30-72 TMFT 36 B30-72
- B35-62 TMFT 36 B35-62
- B35-72 TMFT 36 B35-72
- B35-80 TMFT 36 B35-80

TMFT 36 C..

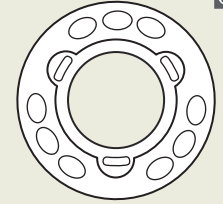

- C40-68 TMFT 36 C40-68
- C40-80 TMFT 36 C40-80
- C40-90 TMFT 36 C40-90
- C45-75 TMFT 36 C45-75
- C45-85 TMFT 36 C45-85
- C45-100 TMFT 36 C45-10
- C50-80 TMFT 36 C50-80
- C50-90 TMFT 36 C50-90
- C50-110 TMFT 36 C50-11
- C55-90 TMFT 36 C55-90
- C55-100 TMFT 36 C55-10
- C55-120 TMFT 36 C55-12

TMFT 36 A



TMFT 36 B



TMFT 36 C



TMFT 36-H

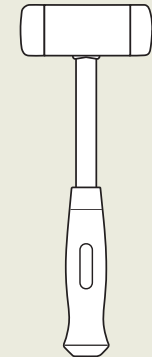

TMFT 36-CC

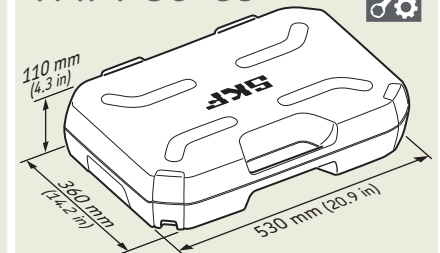

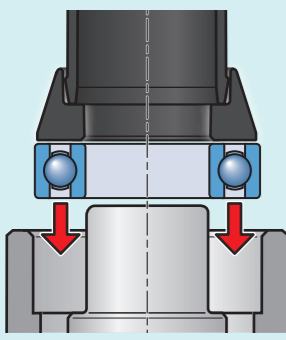

d - D (mm)	10-26	10-30	10-35	12-28	12-32	12-37	15-32	15-35	15-42	17-35	17-40	17-47	20-42	20-47	20-52	25-47	25-52	25-62	30-55	30-62	30-72	35-62	35-72	35-80	40-68	40-80	40-90	45-75	45-85	45-100	50-80	50-90	50-110	55-90	55-100	55-120			
d - D (in)	0.4-1.0	0.4-1.2	0.4-1.4	0.5-1.1	0.5-1.3	0.5-1.5	0.6-1.1	0.6-1.4	0.6-1.7	0.7-1.4	0.7-1.6	0.7-1.9	0.8-1.7	0.8-1.8	0.8-2.0	1.0-1.8	1.0-2.0	1.0-2.4	1.2-2.2	1.2-2.4	1.2-2.8	1.4-2.4	1.4-2.8	1.4-3.1	1.6-2.7	1.6-3.1	1.6-3.5	1.8-3.0	1.8-3.4	1.8-3.9	2.0-3.1	2.0-3.5	2.0-3.9	2.2-3.5	2.2-3.9	2.2-4.7			
60..	6000			6001			6002			6003			6004*			6005			6006			6007			6008			6009			6010			6011					
62..	629	6200			6201			6202			6203		6204			62/22	6205		62/28	6206		6207				6208			6209		6210			6211					
63..			6300			6301			6302			6303			6304		63/22	6305		63/28	6306			6307			6308			6309			6310			6311			
64..																	6403							6405			6406			6407			6408			6409			
160..							16002			16003			16004*			16005			16006			16007			16008			16009			16010			16011					
161..	16100			16101																																			
63... 62...	63000	62200	62300	63001	62201	62301	63002	62202	62302	63003	62203	62303	63004*	62204	62304	63005	62205	62305	63006	62206	62306	63007	62207	62307	63008	62208	62308	63009	62209	62309	63010	62210	62310		62211	62311			
2.. 3..																			206	306			307		208	308		209	309		210	310		211	311				
361... 305...		361200 305800			361201 305801			361202 305802				361203 305803			361204 305804				361205 305805			361206 305806		361207 305807															
72.. 73..		7200			7201	7301		7202	7302		7203	7303		7204	7304		7205	7305		7206	7306		7207	7307		7208	7308		7209	7309		7210	7310		7211	7311			
QJ..								QJ202			QJ203	QJ303			QJ304		QJ205	QJ305		QJ206	QJ306		QJ207	QJ307		QJ208	QJ308		QJ209	QJ309		QJ210	QJ310		QJ211	QJ311			
42.. 43..		4200			4201	4301		4202	4302		4203	4303		4204	4304		4205	4305		4206	4306		4207	4307		4208	4308		4209	4309		4210	4310		4211	4311			
32.. 33..		3200			3201			3202	3302		3203	3303		3204	3304		3205	3305		3206	3306		3207	3307		3208	3308		3209	3309		3210	3310		3211	3311			
12.. 13.. 22.. 23..	129	1200			1201	1301		1202	1302		1203	1303		1204	1304		1205	1305		1206	1306		1207	1307		1208	1308		1209	1309		1210	1310		1211	1311			
213.. 222.. 223..		2200			2201	2301		2202	2302		2203	2303		2204	2304		2205	2305		2206	2306		2207	2307		2208	2308		2209	2309		2210	2310		2211	2311			
213.. 222.. 223..															22205/20		21305			21306			21307			21308			21309			21310			21311				
N10.. N2.. N3.. N22.. N23..							N202				N203	N303		N204	N304	N1005	N205	N305	N1006	N206	N306	N1007	N207	N307	N1008	N208	N308	N1009	N209	N309	N1010	N210	N310	N1011	N211	N311			
N10.. N2.. N3.. N22.. N23..											N2203			N2204	N2304		N2205	N2305		N2206	N2306		N2207	N2307		N2208	N2308		N2209	N2309		N2210	N2310		N2211	N2311			
320.. 302.. 303.. 330.. 322.. 313.. 331.. 332.. 323..									30302		30203	30303	32004*	30204	30304	32005	30205	30305	32006	30206	30306	32007	30207	30307	32008	30208	30308	32009	30209	30309	32010	30210	30310	32011	30211	30311			
320.. 302.. 303.. 330.. 322.. 313.. 331.. 332.. 323..																	32205	31305		32206	31306		32207	31307		32208	31308		32209	31309	33010	32210	31310	33011	32211	31311			
320.. 302.. 303.. 330.. 322.. 313.. 331.. 332.. 323..																	33205	32305		33206	32306		33207	32307		33208	32308	33109	33209	32309	33110	33210	32310	33111	33211	32311			
CARB																										C2208			C2209			C4010	C2210			C2211			

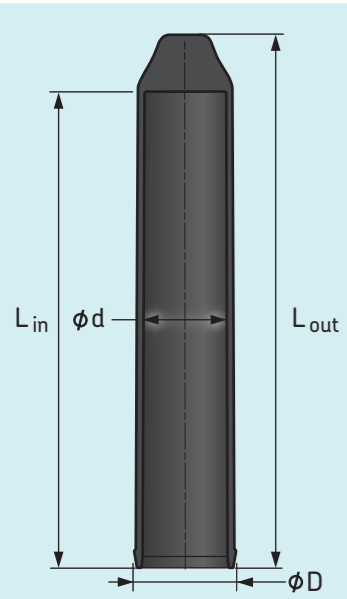

		TMFT 36 A	TMFT 36 B	TMFT 36 C
d	mm	18	37	57
	in	0.7	1.4	2.2
D	mm	25	45	66
	in	1.0	1.7	2.6
L _{out}	mm	228	235	245
	in	9.0	9.3	9.6
L _{in}	mm	210	210	215
	in	8.3	8.3	8.4

		A A					B B					C C								
d-D (mm)		10-26	10-30	12-28	12-37	15-32	17-35	20-42	25-47	30-55	35-62	35-72	40-68	40-90	45-75	45-85	45-100	50-80	50-110	55-90
	618.. 619..	61803		61805	61804			61806	61807	61809	61810	61811					61911			
			61903	61902	61904			61905	61906	61907	61908	61910	61909							
	N 4.. N 4..												N406			N407			N408 N409	
	CARB									C4908	C4910	C6909			C6912		C6911			
	60.. 160.. 618.. 619.. 638..		16100		16101			6004						61808	61809			61810	61811	
		61800		61801		61802	61803	61804	61805	61806	61807			61908	61909			61910	61911	
		61900		61901		61902	61903	61904	61905	61906	61907									
		63800		63801		63802	63803	63804	63805											
	630..							63004												
	N 4..									N406	N407		N408		N409					
	CARB											C4908		C6909			C4910	C6910		

