

Scale - 1:2

### Applicable Cable Diameter: [mm]

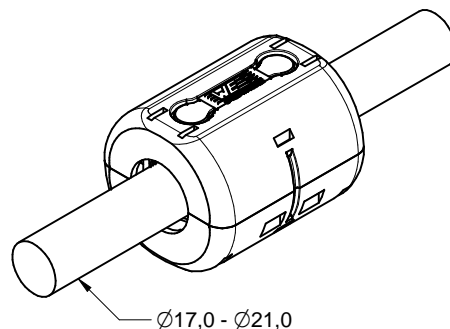

### Electrical Properties

| Properties                  | Test conditions |   | Value | Unit | Tol. |
|-----------------------------|-----------------|---|-------|------|------|
| Impedance @ 25 MHz 1 turn   | 25 MHz          | Z | 233   | Ω    | ±25% |
| Impedance @ 100 MHz 1 turn  | 100 MHz         | Z | 425   | Ω    | ±25% |
| Impedance @ 25 MHz 2 turns  | 25 MHz          | Z | 889   | Ω    | typ. |
| Impedance @ 100 MHz 2 turns | 100 MHz         | Z | 982   | Ω    | typ. |

### General Information

|                                                                                     |                 |                      |
|-------------------------------------------------------------------------------------|-----------------|----------------------|
| Storage Temperature (in original packaging)                                         | T <sub>S</sub>  | 0 °C up to +40 °C    |
| Operating Temperature                                                               | T <sub>OP</sub> | -25 °C up to +105 °C |
| Test conditions of Electrical Properties: 20°C, 33% RH if not specified differently |                 |                      |

### Additional Features

|                            |                        |
|----------------------------|------------------------|
| Safety Key to lock/ unlock | Würth Elektronik 74271 |
|----------------------------|------------------------|

Würth Elektronik eiSos GmbH & Co. KG  
EMC & Inductive Solutions

Max-Eyth-Str. 1  
74638 Waldenburg  
Germany  
Tel. +49 (0) 79 42 945 - 0

www.we-online.com  
eiSos@we-online.com

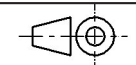

|                                                                        |                 |                                      |                                                                                                            |
|------------------------------------------------------------------------|-----------------|--------------------------------------|------------------------------------------------------------------------------------------------------------|
| CREATED<br>KaS                                                         | CHECKED<br>NFI  | GENERAL TOLERANCE<br>DIN ISO 2768-1m | PROJECTION METHOD<br> |
| DESCRIPTION<br><b>STAR-TEC Snap Ferrite with safety key technology</b> |                 | ORDER CODE<br><b>74271211S</b>       |                                                                                                            |
| REVISION<br>001.000                                                    | STATUS<br>Draft | DATE<br>2016-02-17                   | BUSINESS UNIT<br>eiSos                                                                                     |
|                                                                        |                 | PAGE<br>1/4                          |                                                                                                            |

## General Properties

| Properties                          |         | Value      | Unit |
|-------------------------------------|---------|------------|------|
| Material                            |         | 4 W 620    |      |
| Initial Permeability                | $\mu_i$ | 620        |      |
| Curie Temperature                   | $T_C$   | 150        | °C   |
| Plastic Housing Color               |         | black      |      |
| Flammability Rating Plastic Housing |         | UL94-V0    |      |
| Test Cable                          |         | AWG26      |      |
| Cable Diameter                      |         | 17 - 21 mm |      |

## Typical Impedance Characteristics:

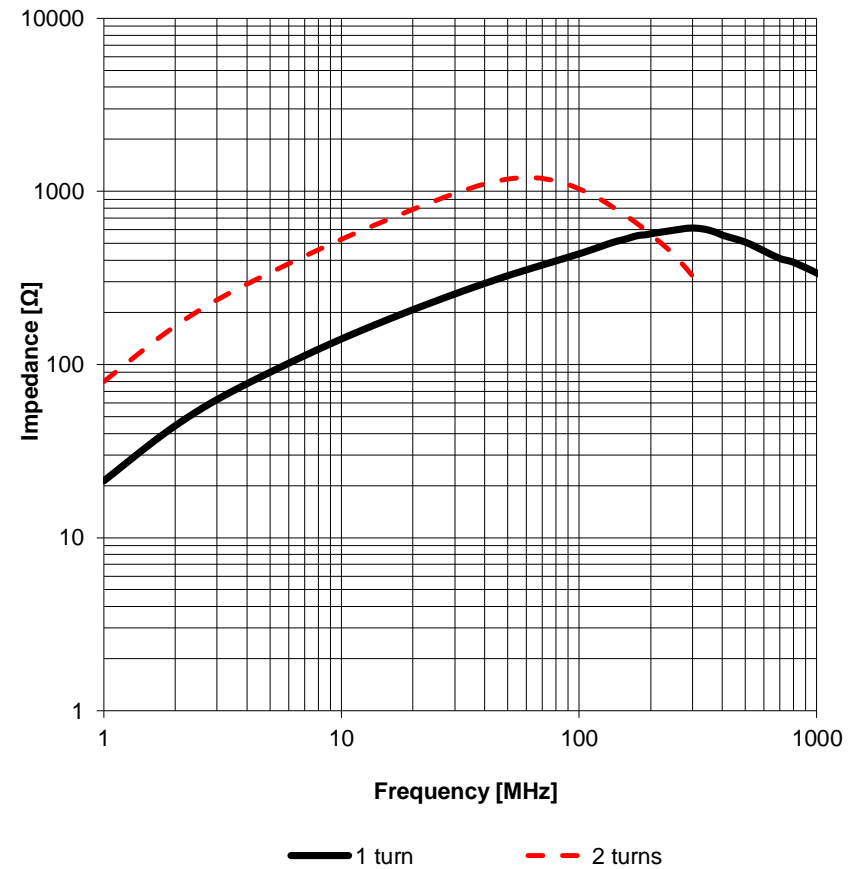

|                                                                                                                                                                                                       |                                                                        |                 |                                      |                                |
|-------------------------------------------------------------------------------------------------------------------------------------------------------------------------------------------------------|------------------------------------------------------------------------|-----------------|--------------------------------------|--------------------------------|
| Würth Elektronik eiSos GmbH & Co. KG<br>EMC & Inductive Solutions<br><br>Max-Eyth-Str. 1<br>74638 Waldenburg<br>Germany<br>Tel. +49 (0) 79 42 945 - 0<br><br>www.we-online.com<br>eiSos@we-online.com | CREATED<br>KaS                                                         | CHECKED<br>NFI  | GENERAL TOLERANCE<br>DIN ISO 2768-1m | PROJECTION METHOD<br>          |
|                                                                                                                                                                                                       | DESCRIPTION<br><b>STAR-TEC Snap Ferrite with safety key technology</b> |                 |                                      | ORDER CODE<br><b>74271211S</b> |
|                                                                                                                                                                                                       | REVISION<br>001.000                                                    | STATUS<br>Draft | DATE<br>2016-02-17                   | BUSINESS UNIT<br>eiSos         |



## Cautions and Warnings:

### The following conditions apply to all goods within the product series of STAR-TEC of Würth Elektronik eiSos GmbH & Co. KG:

#### General:

All recommendations according to the general technical specifications of the data sheet have to be complied with.

The usage and operation of the product within ambient conditions, which probably alloy or harm the component surface, has to be avoided.

The packaging of the product is to encase the needed humidity of the plastic housing. To ensure the humidity level, the products have to be stored in this delivered packaging. If not, the products are losing their humidity. In this case you can re-condition the components according to the internal standard WE1581 to ensure the necessary humidity in the plastic.

To ensure the operating mode of the product, the ambient temperature at processing (when the part will be mounted on the cable) has to be in the range of 15 to 25 °C. Before mounting, the part should be stored for one hour in this condition. The responsibility for the applicability of customer specific products and the use in a particular customer design is always within the authority of the customer. All technical specifications for standard products do also apply to customer specific products.

Direct mechanical impact to the product and the forcible closing of this shall be prevented as the ferrite material of the ferrite body or the plastic housing could flake or in the worst case it could break.

#### Product specific:

Follow all instructions mentioned in the data sheet, especially:

- The cable diameter must be pointed out, otherwise this will void the warranty.
- Violation of the technical product specifications such as exceeding the nominal rated current will void the warranty.

The general and product specific cautions comply with the state of the scientific and technical knowledge and are believed to be accurate and reliable; however, no responsibility is assumed for inaccuracies or incompleteness.

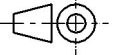
|                                                                                                                                                                                                                                                                                                    |                                                                        |                 |                                      |                                                                                                            |             |
|----------------------------------------------------------------------------------------------------------------------------------------------------------------------------------------------------------------------------------------------------------------------------------------------------|------------------------------------------------------------------------|-----------------|--------------------------------------|------------------------------------------------------------------------------------------------------------|-------------|
| Würth Elektronik eiSos GmbH & Co. KG<br>EMC & Inductive Solutions<br><br>Max-Eyth-Str. 1<br>74638 Waldenburg<br>Germany<br>Tel. +49 (0) 79 42 945 - 0<br><br>www.we-online.com<br>eiSos@we-online.com<br><br> | CREATED<br>KaS                                                         | CHECKED<br>NFI  | GENERAL TOLERANCE<br>DIN ISO 2768-1m | PROJECTION METHOD<br> |             |
|                                                                                                                                                                                                                                                                                                    | DESCRIPTION<br><b>STAR-TEC Snap Ferrite with safety key technology</b> |                 |                                      | ORDER CODE<br><b>74271211S</b>                                                                             |             |
|                                                                                                                                                                                                                                                                                                    | REVISION<br>001.000                                                    | STATUS<br>Draft | DATE<br>2016-02-17                   | BUSINESS UNIT<br>eiSos                                                                                     | PAGE<br>3/4 |

## Important Notes

### The following conditions apply to all goods within the product range of Würth Elektronik eiSos GmbH & Co. KG:

#### 1. General Customer Responsibility

Some goods within the product range of Würth Elektronik eiSos GmbH & Co. KG contain statements regarding general suitability for certain application areas. These statements about suitability are based on our knowledge and experience of typical requirements concerning the areas, serve as general guidance and cannot be estimated as binding statements about the suitability for a customer application. The responsibility for the applicability and use in a particular customer design is always solely within the authority of the customer. Due to this fact it is up to the customer to evaluate, where appropriate to investigate and decide whether the device with the specific product characteristics described in the product specification is valid and suitable for the respective customer application or not.

#### 2. Customer Responsibility related to Specific, in particular Safety-Relevant Applications

It has to be clearly pointed out that the possibility of a malfunction of electronic components or failure before the end of the usual lifetime cannot be completely eliminated in the current state of the art, even if the products are operated within the range of the specifications. In certain customer applications requiring a very high level of safety and especially in customer applications in which the malfunction or failure of an electronic component could endanger human life or health it must be ensured by most advanced technological aid of suitable design of the customer application that no injury or damage is caused to third parties in the event of malfunction or failure of an electronic component. Therefore, customer is cautioned to verify that data sheets are current before placing orders. The current data sheets can be downloaded at [www.we-online.com](http://www.we-online.com).

#### 3. Best Care and Attention

Any product-specific notes, cautions and warnings must be strictly observed. Any disregard will result in the loss of warranty.

#### 4. Customer Support for Product Specifications

Some products within the product range may contain substances which are subject to restrictions in certain jurisdictions in order to serve specific technical requirements. Necessary information is available on request. In this case the field sales engineer or the internal sales person in charge should be contacted who will be happy to support in this matter.

#### 5. Product R&D

Due to constant product improvement product specifications may change from time to time. As a standard reporting procedure of the Product Change Notification (PCN) according to the JEDEC-Standard inform about minor and major changes. In case of further queries regarding the PCN, the field sales engineer or the internal sales person in charge should be contacted. The basic responsibility of the

customer as per Section 1 and 2 remains unaffected.

#### 6. Product Life Cycle

Due to technical progress and economical evaluation we also reserve the right to discontinue production and delivery of products. As a standard reporting procedure of the Product Termination Notification (PTN) according to the JEDEC-Standard we will inform at an early stage about inevitable product discontinuance. According to this we cannot guarantee that all products within our product range will always be available. Therefore it needs to be verified with the field sales engineer or the internal sales person in charge about the current product availability expectancy before or when the product for application design-in disposal is considered. The approach named above does not apply in the case of individual agreements deviating from the foregoing for customer-specific products.

#### 7. Property Rights

All the rights for contractual products produced by Würth Elektronik eiSos GmbH & Co. KG on the basis of ideas, development contracts as well as models or templates that are subject to copyright, patent or commercial protection supplied to the customer will remain with Würth Elektronik eiSos GmbH & Co. KG. Würth Elektronik eiSos GmbH & Co. KG does not warrant or represent that any license, either expressed or implied, is granted under any patent right, copyright, mask work right, or other intellectual property right relating to any combination, application, or process in which Würth Elektronik eiSos GmbH & Co. KG components or services are used.

#### 8. General Terms and Conditions

Unless otherwise agreed in individual contracts, all orders are subject to the current version of the "General Terms and Conditions of Würth Elektronik eiSos Group", last version available at [www.we-online.com](http://www.we-online.com).

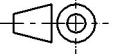
|                                                                                                                                                                                                                                                                                                                                                                                    |                                                                        |                 |                                      |                                                                                                            |             |
|------------------------------------------------------------------------------------------------------------------------------------------------------------------------------------------------------------------------------------------------------------------------------------------------------------------------------------------------------------------------------------|------------------------------------------------------------------------|-----------------|--------------------------------------|------------------------------------------------------------------------------------------------------------|-------------|
| Würth Elektronik eiSos GmbH & Co. KG<br>EMC & Inductive Solutions<br><br>Max-Eyth-Str. 1<br>74638 Waldenburg<br>Germany<br>Tel. +49 (0) 79 42 945 - 0<br><br><a href="http://www.we-online.com">www.we-online.com</a><br><a href="mailto:eiSos@we-online.com">eiSos@we-online.com</a><br><br> | CREATED<br>KaS                                                         | CHECKED<br>NFI  | GENERAL TOLERANCE<br>DIN ISO 2768-1m | PROJECTION METHOD<br> |             |
|                                                                                                                                                                                                                                                                                                                                                                                    | DESCRIPTION<br><b>STAR-TEC Snap Ferrite with safety key technology</b> |                 |                                      | ORDER CODE<br><b>74271211S</b>                                                                             |             |
|                                                                                                                                                                                                                                                                                                                                                                                    | REVISION<br>001.000                                                    | STATUS<br>Draft | DATE<br>2016-02-17                   | BUSINESS UNIT<br>eiSos                                                                                     | PAGE<br>4/4 |