

## Features

- 300 Watts Peak Pulse Power ( $t_p = 8 \times 20 \mu s$ )
- IEC 61000-4-2 (ESD): Air – 15kV, Contact – 8kV
- Dual Common Anode TVS
- SOT-23 Package Allows Either Two Separate Unidirectional Configurations or a Single Bidirectional Configuration
- **Lead Free/RoHS Compliant (Note 3)**
- **“Green” Device (Note 4)**
- **Qualified to AEC-Q101 Standards for High Reliability**

## Mechanical Data

- Case: SOT-23
- Case Material: Molded Plastic, “Green” Molding Compound, Note 3. UL Flammability Classification Rating 94V-0
- Moisture Sensitivity: Level 1 per J-STD-020
- Terminals: Matte Tin Finish annealed over Alloy 42 leadframe (Lead Free Plating) Solderable per MIL-STD-202, Method 208
- Ordering Information: See Page 2
- Marking Information: See Page 2
- Weight: 0.0089 grams (approximate)



Top View

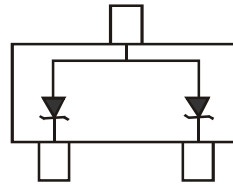

Device Schematic

## Thermal Characteristics

Characteristic	Symbol	Value	Unit
Peak Pulse Power ( $t_p = 8 \times 20 \mu s$ ) (Note 6) $T_A = 25^\circ C$	$P_{pk}$	300	W
Thermal Resistance, Junction to Ambient (Note 6) $T_A = 25^\circ C$	$R_{\theta JA}$	417	$^\circ C/W$
Operating and Storage Temperature Range	$T_J, T_{STG}$	-55 to +150	$^\circ C$

## Electrical Characteristics @ $T_A = 25^\circ C$ unless otherwise specified (Note 7)

Reverse Standoff Voltage $V_{RWM}$ (V)	Breakdown Voltage $V_{BR}$ @ $I_T$		Test Current $I_T$ (mA)	Max. Reverse Leakage @ $V_{RWM}$ (Note 5) $I_R$ ( $\mu A$ )	Max. Clamping Voltage @ $I_{PP} = 5A$ (Note 2) $V_C$ (V)	Max. Clamping Voltage $V_C$ @ $I_{PP}$ (Note 2) $V_C$ (V) $I_{PP}$ (A)		Typical Capacitance $C_T$ (Note 1) (pF)
	Min (V)	Max (V)						
5	6.2	7.3	1.0	10	9.8	20.6	17	230

- Notes:
1.  $V_R = 0V, f = 1MHz$ .
  2. Clamping voltage value is based on an  $8 \times 20 \mu s$  peak pulse current ( $I_{pp}$ ) waveform.
  3. No purposefully added lead.
  4. Diodes Inc.'s “Green” policy can be found on our website at [http://www.diodes.com/products/lead\\_free/index.php](http://www.diodes.com/products/lead_free/index.php).
  5. Short duration pulse test used to minimize self-heating effect.
  6. Device mounted on FR-4 PC board with suggested pad layout, which can be found on our website at <http://www.diodes.com/datasheets/ap02001.pdf>. Measured across pin 1 and pin 2.

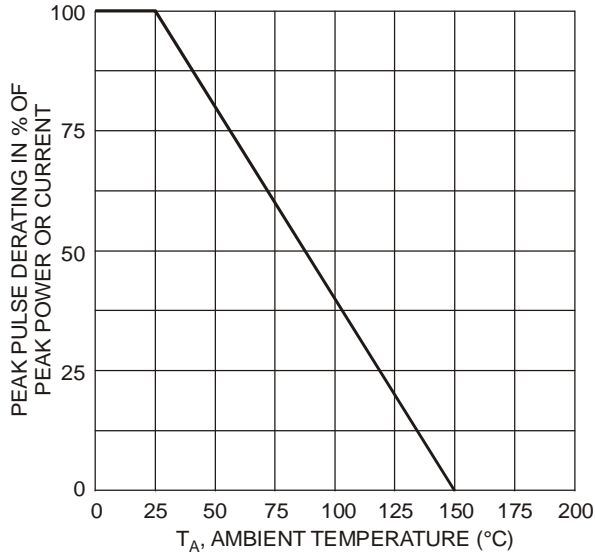

Fig. 1 Pulse Derating Curve

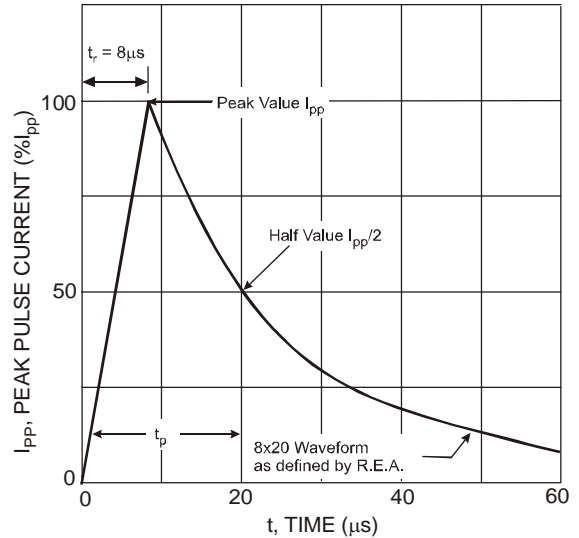

Fig. 2 Pulse Waveform

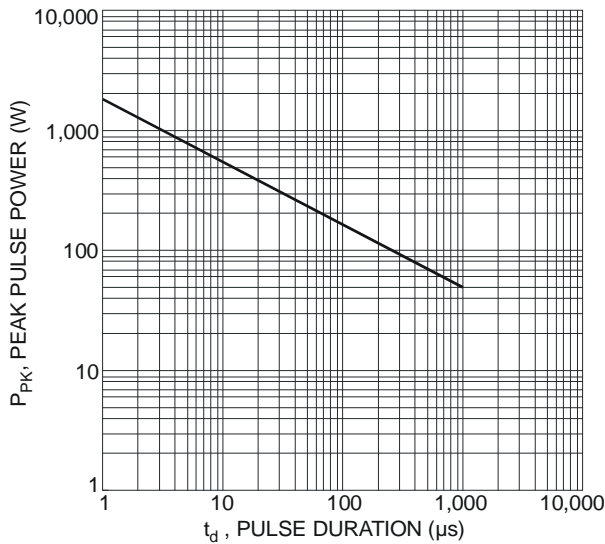

Fig. 3 Max. Peak Pulse Power vs. Pulse Duration

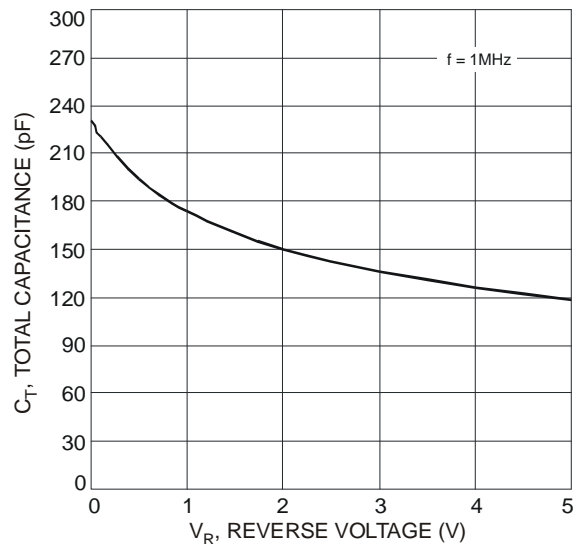

Fig. 4 Typical Total Capacitance vs. Reverse Voltage

**Ordering Information** (Note 8)

Part Number	Case	Packaging
SM05-7	SOT-23	3000/Tape & Reel

Notes: 8. For packaging details, go to our website at <http://www.diodes.com/datasheets/ap02007.pdf>.

**Marking Information**

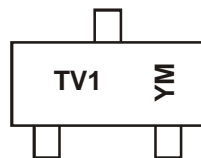

TV1 = Product Type Marking Code  
 YM = Date Code Marking  
 Y = Year (ex: X = 2010)  
 M = Month (ex: 9 = September)

Date Code Key

Year	2010	2011	2012	2013	2014	2015	2016
Code	X	Y	Z	A	B	C	D

Month	Jan	Feb	Mar	Apr	May	Jun	Jul	Aug	Sep	Oct	Nov	Dec
Code	1	2	3	4	5	6	7	8	9	O	N	D

**Package Outline Dimensions**

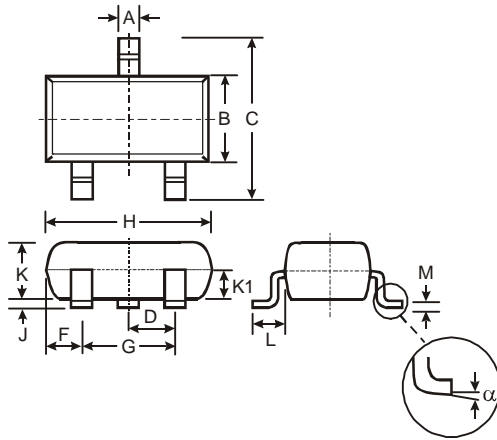

SOT-23			
Dim	Min	Max	Typ
A	0.37	0.51	0.40
B	1.20	1.40	1.30
C	2.30	2.50	2.40
D	0.89	1.03	0.915
F	0.45	0.60	0.535
G	1.78	2.05	1.83
H	2.80	3.00	2.90
J	0.013	0.10	0.05
K	0.903	1.10	1.00
K1	-	-	0.400
L	0.45	0.61	0.55
M	0.085	0.18	0.11
α	0°	8°	-

All Dimensions in mm

**Suggested Pad Layout**

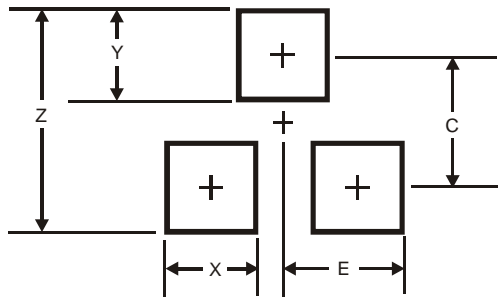

Dimensions	Value (in mm)
Z	2.9
X	0.8
Y	0.9
C	2.0
E	1.35

**IMPORTANT NOTICE**

DIODES INCORPORATED MAKES NO WARRANTY OF ANY KIND, EXPRESS OR IMPLIED, WITH REGARDING TO THIS DOCUMENT, INCLUDING, BUT NOT LIMITED TO, THE IMPLIED WARRANTIES OF MERCHANTABILITY AND FITNESS FOR A PARTICULAR PURPOSE (AND THEIR EQUIVALENTS UNDER THE LAWS OF ANY JURISDICTION).

Diodes Incorporated and its subsidiaries reserve the right to make modifications, enhancements, improvements, corrections or other changes without further notice to this document and any product described herein. Diodes Incorporated does not assume any liability arising out of the application or use of this document or any product described herein; neither does Diodes Incorporated convey any license under its patent or trademark rights, nor the rights of others. Any Customer or user of this document or products described herein in such applications shall assume all risks of such use and will agree to hold Diodes Incorporated and all the companies whose products are represented on Diodes Incorporated website, harmless against all damages.

Diodes Incorporated does not warrant or accept any liability whatsoever in respect of any products purchased through unauthorized sales channel. Should Customers purchase or use Diodes Incorporated products for any unintended or unauthorized application, Customers shall indemnify and hold Diodes Incorporated and its representatives harmless against all claims, damages, expenses, and attorney fees arising out of, directly or indirectly, any claim of personal injury or death associated with such unintended or unauthorized application.

Products described herein may be covered by one or more United States, international or foreign patents pending. Product names and markings noted herein may also be covered by one or more United States, international or foreign trademarks.

**LIFE SUPPORT**

Diodes Incorporated products are specifically not authorized for use as critical components in life support devices or systems without the express written approval of the Chief Executive Officer of Diodes Incorporated. As used herein:

A. Life support devices or systems are devices or systems which:

1. are intended to implant into the body, or
2. support or sustain life and whose failure to perform when properly used in accordance with instructions for use provided in the labeling can be reasonably expected to result in significant injury to the user.

B. A critical component is any component in a life support device or system whose failure to perform can be reasonably expected to cause the failure of the life support device or to affect its safety or effectiveness.

Customers represent that they have all necessary expertise in the safety and regulatory ramifications of their life support devices or systems, and acknowledge and agree that they are solely responsible for all legal, regulatory and safety-related requirements concerning their products and any use of Diodes Incorporated products in such safety-critical, life support devices or systems, notwithstanding any devices- or systems-related information or support that may be provided by Diodes Incorporated. Further, Customers must fully indemnify Diodes Incorporated and its representatives against any damages arising out of the use of Diodes Incorporated products in such safety-critical, life support devices or systems.

Copyright © 2010, Diodes Incorporated

[www.diodes.com](http://www.diodes.com)