



SERIES 1010 - OPEN SNAP-ACTION SWITCHES

TO 6 (2) A 250 V AC



PRODUCT FEATURES

- Powerful snap-action switch with C-spring contact system according to design DIN 41635C
- High switching reliability due to large contact forces directly after switching
- Small size, large travel and difference travel
- Short bounce time
- Contact system insensitive to vibrations

ON REQUEST

- Extended overtravel
- Special base forms
- Special actuating cams
- In addition to a wide range of normally closed contacts, normally open contacts and changeover switches and spring sets without snap function (basic type 1017) are available

Design	DIN 41635 C
Contact resistance (new condition)	< 100 mOhm (1 A 12 V DC)
Insulation resistance (new condition)	> 100 MOhm (500 V DC)
Proof tracking	250 PTI
Protection type	IP 00
Ambient temperature	-20 °C ... +85 °C ... 120 °C (basic type 1014)
Flammability	UL 94 V-2 or UL 94 HB
Glow wire test temperature	850 °C
Material actuator housing terminals	spring steel / PA glass fiber-reinforced / PA / metal (only 1017.0153) PA glass fiber-reinforced / PA silver plated
Bounce time	< 5 ms
Approval marks	
Suitable for appliances of protection class II under compliance with the installation conditions required on the equipment side	

ROCKER SWITCHES

PUSHBUTTON SWITCHES

TOGGLE SWITCHES

SLIDE SWITCHES

ROTARY SWITCHES

FOOT SWITCHES

TACT AND KEY SWITCHES

SNAP-ACTION SWITCHES

MICRO-SIGNAL SWITCHES

SENSORS

ECO

PUSH IN DRIVE



SERIES 1010 - OPEN SNAP-ACTION SWITCHES

TO 6 (2) A 250 V AC

	6 (2) A 250 V AC 25E3	2 (0.5) A 250 V AC 20E4	2 (0.5) A 250 V AC 5E4	2 A 12 V DC 10E4	1 A 24 V DC 10E4	0.5 A 15 V 5E4	0.1 A 24 V DC 5E4	30 mA 12 V 5E4	Terminal type	Terminal description	Contact material	Operating force (N)	Operating position (OP) (mm)	Difference travel max. (mm)	Free position (FP) max. (mm)	Permissible total travel position (TP) (mm)	Actuator description	Mechanical life endurance	Miscellaneous	Stock version
Normally closed contact (SPNC)																				
1010.7601		o								9.5 long	Ag	0.25 - 0.6	2.2 ±0.6	0.9	0.4	3.5		1E6		
Normally open contact (SPNO)																				
1010.7401		o								9.5 long	Ag	0.25 - 0.6	2.2 ±0.6	0.9	0.4	3.5		1E6		
1010.7402		o								9.5 long	Ag	0.45 - 1.05	2.2 ±0.6	0.9	0.4	3.5		1E6		
1017.0801						o				9.2 long	CuBe silver plated	0.15 - 0.5	2.2 ±0.6		0	3.2		1E6	without approval mark	o
1017.5701						o					CuSn silver plated	0.15 - 0.5	1.4 ±0.6		3.6	0.4		1E6	without approval mark	
1017.0851							o			9.2 long	Au	0.15 - 0.5	2.2 ±0.6		0	3.2		1E6	without approval mark	
Changeover switch (SPDT momentary)																				
1010.9705	o	o									Au	0.45 - 1.05	3.8 ±0.6	0.9	6.6	2		10E4		
1010.9752	o	o									Ag	0.45 - 1.05	6.9 ±0.6	0.9	9.7	5.1		10E4		
1010.9802	o	o									Ag	0.45 - 1.05	3.8 ±0.6	0.9	6.6	2		10E4		
1010.9852	o	o									Ag	0.45 - 1.05	6.9 ±0.6	0.9	9.7	5.1		10E4		o
1010.0101		o								6.5 long	Ag	0.25 - 0.6	2.2 ±0.6	0.9	0.4	3.5		1E6	without approval mark	o
1010.3001		o								6.5 long	Ag	0.25 - 0.6	0.9 ±0.6	0.9	3.6	0.2		1E6		
1010.4402		o								straight	Ag	0.25 - 0.6	1.3 ±0.6	0.9	4.1	0		1E6	small base without approval mark	
1010.0304		o								9.5 long	Ag	0.25 - 0.6	2.2 ±0.6	0.9	0.4	3.5		1E6		
1010.2003		o								9.5 long	Au	0.45 - 1.05	2.2 ±0.6	0.9	0.4	3.5		1E6		
1010.4103		o								straight	Au	0.25 - 0.6	2.2 ±0.6	0.9	0.4	3.5		1E6	without approval mark	o
1010.6002		o								standing	Au	0.45 - 1.05	11.2 ±0.6	0.9	13.8	9.9		1E6		o
1010.6003		o								standing	Ag	0.25 - 0.6	11.2 ±0.6	0.9	13.8	9.9		1E6		o
1010.7102		o								6.5 long	Ag	0.45 - 1.05	2.2 ±0.6	0.9	0.4	3.5		1E6	without approval mark	
1010.7172		o								6.5 long	Au	0.45 - 1.05	0.9 ±0.6	0.9	3.6	0.2		1E6	without approval mark	
1010.7352		o								9.5 long	Ag	0.45 - 1.05	0.9 ±0.6	0.9	3.6	0.2		1E6		
1010.8102		o								straight	Ag	0.45 - 1.05	2.2 ±0.6	0.9	0.4	3.5		1E6	without approval mark	
1014.6151			o	o						standing	Au	0.3 - 0.8	6.6 ±0.5	0.6	8.6	5.3		50E4	without approval mark	
Changeover switch with OFF position in the center (SPDT momentary - Center OFF)																				
1017.0153						o				9.2 long	Au		≤ 2.1		0	0.5		1E6	without approval mark operating range max. 4.2	



SERIES 1010 - OPEN SNAP-ACTION SWITCHES

TO 6 (2) A 250 V AC



Basic type 1010

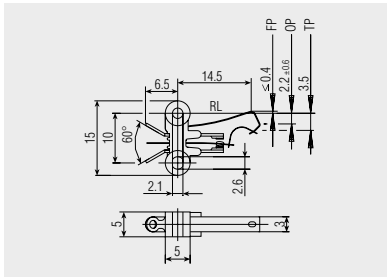

Solder terminal
30° angled

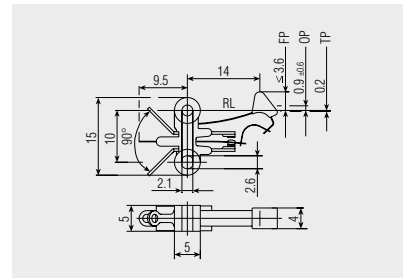

Solder terminal
45° angled

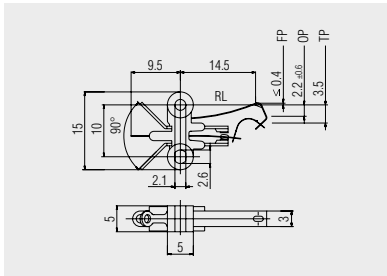

Solder terminal
45° angled

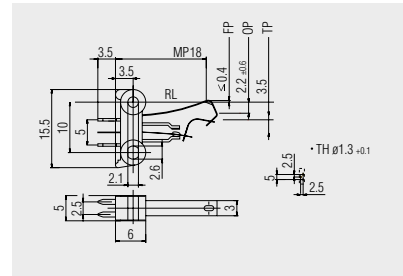

PCB terminal
straight

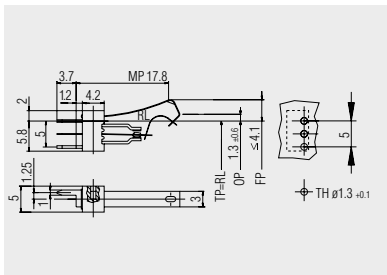

PCB terminal
straight

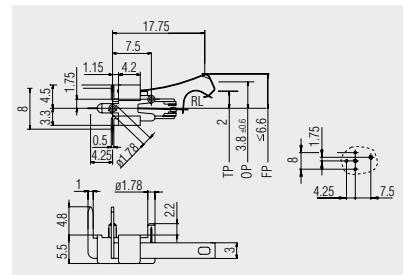

PCB terminal
left angled

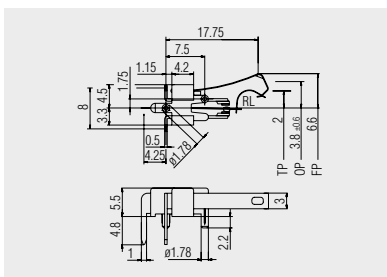

PCB terminal
right angled
1010.9802

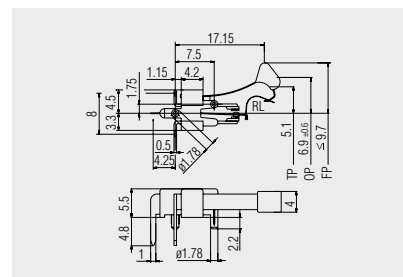

PCB terminal
right angled
1010.9852

ROCKER SWITCHES
 PUSHBUTTON SWITCHES
 TOGGLE SWITCHES
 SLIDE SWITCHES
 ROTARY SWITCHES
 FOOT SWITCHES
 TACT AND KEY SWITCHES
 SNAP-ACTION SWITCHES
 MICRO-SIGNAL SWITCHES
 SENSORS
 ECO
 PUSH N' DRIVE



SERIES 1010 - OPEN SNAP-ACTION SWITCHES

TO 6 (2) A 250 V AC



Basic type 1010

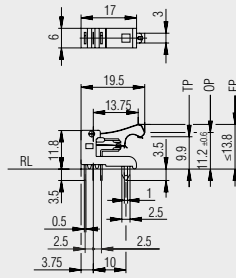

PCB terminal vertical:

A switch actuation vertical to the PCB can be implemented in a confined space with this version.



Basic type 1014

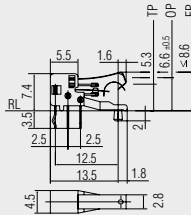

Vertical PCB terminal:

According to the same functional principle as basic type 1010, but in smaller size.

This basic type is designed for low voltages and has no approval mark.



Basic type 1017 without snap function

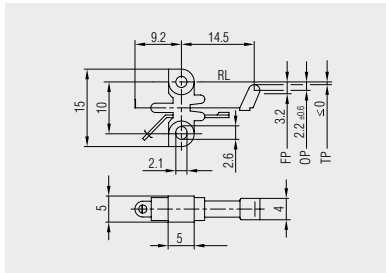

Solder terminal normally open contact version

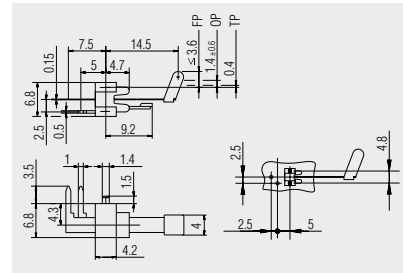

PCB terminal left angled

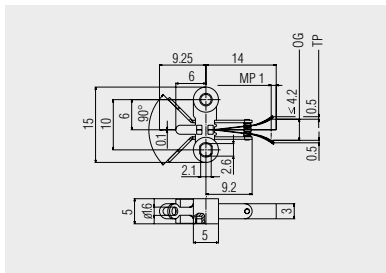

Changeover switch with OFF position in the center

ROCKERSWITCHES

PUSHBUTTON SWITCHES

TOGGLE SWITCHES

SLIDE SWITCHES

ROTARY SWITCHES

FOOT SWITCHES

TACT AND KEY SWITCHES

SNAP-ACTION SWITCHES

MICRO-SIGNAL SWITCHES

SENSORS

ECO

PUSH'N'DRIVE

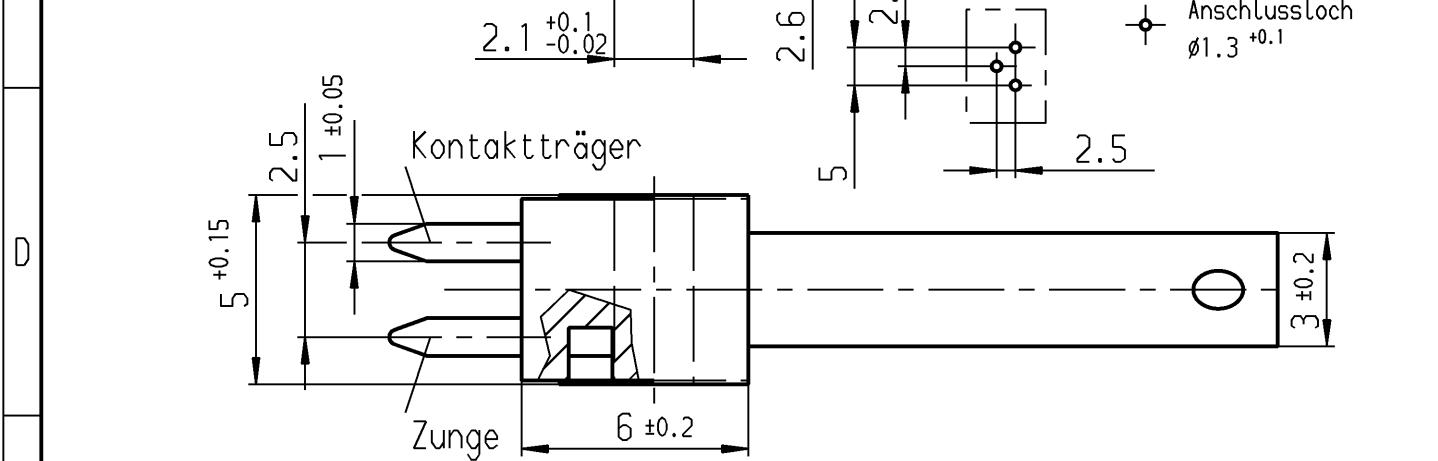
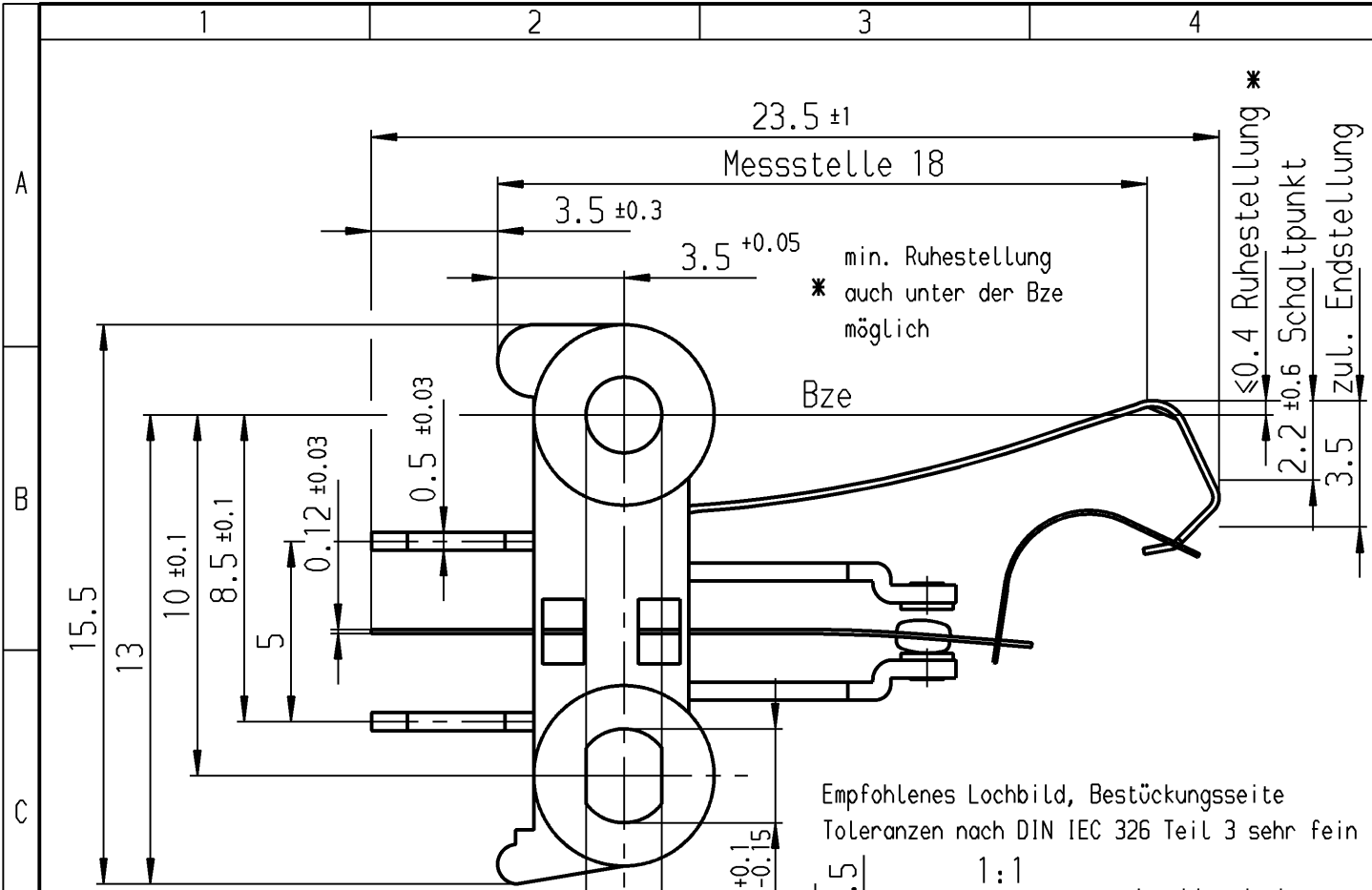

Aufschrift

Ⓜ 1010 μ
 2(0.5)/250~
 Auf Verpackung
 MARQUARDT
 1010.8102 μ
 2(0.5)/250~50E3 T85

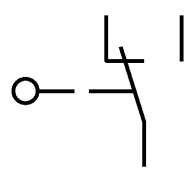

Wechsler 1-polig
 Schalt- Betätigungskraft 0.45 bis 1.05 N
 Differenzweg ≤ 0.9mm

Diese Unterlage ist geistiges Eigentum der Marquardt GmbH. Schutzvermerk nach DIN 34 beachten. Copyright reserved.

Für Form und Lage FOR SHAPE AND LOC.		Für Winkel FOR ANGLE ± 2°		Allgemeintoleranzen UNTOLERANCED DIMENSIONS			Pause COPY		Blatt SHEET		Typ		Zeichn./DRAWING NO.		Index		
PROJECTION		Abmasse und Nennmassbereiche Angaben in mm		Laengen LENGTH		Radien RADII		Original DIN		Maßstab SCALE		K		1010.8102			
ALL DIMENSIONS ARE IN MILLIMETRES				0-6 ± 0.1		± 0.2		A3		5:1							
				>6-15 ± 0.15		± 0.3											
				>15-30 ± 0.2		± 0.5											
				>30-70 ± 0.3		± 10%											
				>70-120 ± 0.4													
				>120-200 ± 0.8													
c 34656 18.03.03 vor		g		CAD Medusa		Z											
b 17287 09.06.86 Wa		f		gez./DRAWN BY 08.10.02 vor													
a 14709 01.10.82 Gü		e		gepr./CHECKED BY													
Ausg. ISSUE		Änderung REVISION		gez. DRAWN BY		Ausg. ISSUE		Änderung REVISION		gez. DRAWN BY		Ersatz für/REPLACEMENT OF		Zng.gL.Nr. vom 28.07.82		MARQUARDT	
																Marquardt GmbH, D-78604 Rietheim-Weilheim	