

**Bourdon tube pressure gauges, liquid filled,**

**Modelcode type: 213.53.0XX**

**Item number: 82414888**

Description	
Design according	EN 837-1
Accuracy class	class 1.6
Scale range	0...2.5 MPa
Constructional design	
Process connection	G 1/4 B
Connector location	back mount
Pressure element	Copper alloy
Movement	Copper alloy
Case	Crimp ring case (version 53)
Nominal size	063 mm
Case filling fluid	prepared for filling
Pointer	plastic, black
Window	plastic, clear
Dial	plastic, white, with stop-pin
Options	
Mounting flange/bracket	narrow panel ring, SS,rolled on,with mounting bracket
Operating conditions	
Pressure limitation	Steady: 3/4 x full scale value Fluctuating: 2/3 x full scale value Short time: Full scale value
Permissible ambient temperature	-20 ... +60 °C
Permissible medium temperature	+60°C maximum
Temperature effect when the temperature deviates from the reference temperature (+20°C)	Max. +/-0.4 %/10 K of the span
Ingress protection	IP 65
Dial description:	
Pressure Gauge Standard	China

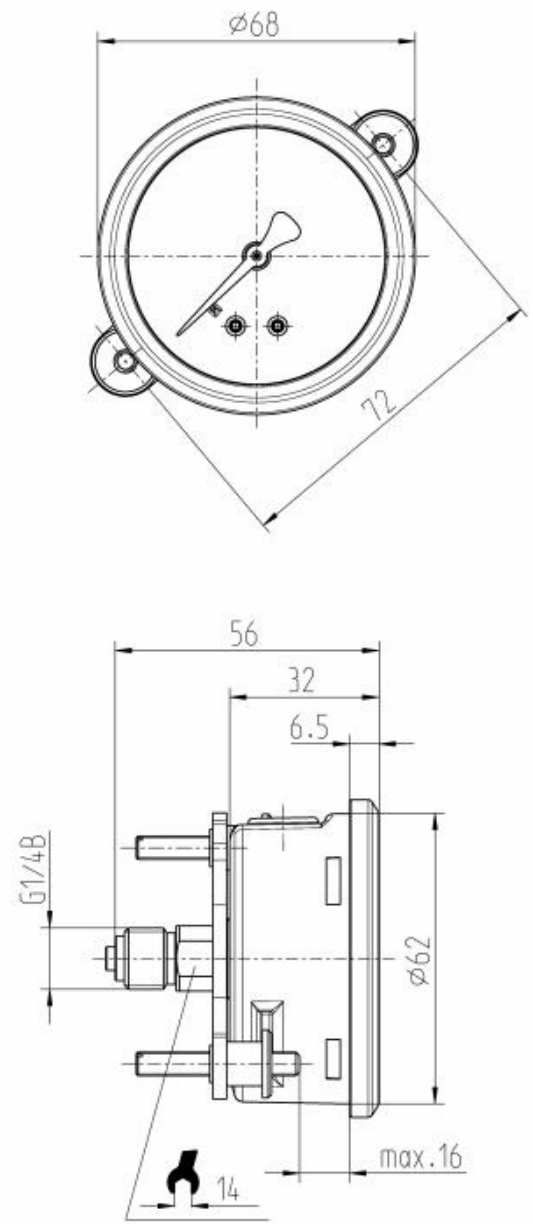

**Bourdon tube pressure gauges, liquid filled,**

**Modelcode type: 213.53.0XX**

**Item number: 82414888**

color for 1.scale (outside)	black
dial background	White
Manufacturer logo	*WIKA*
stop pin on dial	at zero
norm-mark on dial	*EN 837-1*
safetymark on dial	*S*
accuracy class on dial	*Cl.1.6*

Labelcode	
Label	WIKA standard
language of the label	German