

Parallel gripper HGPT

FESTO

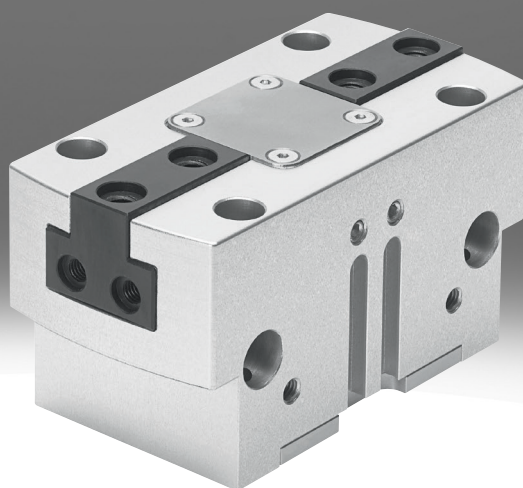

Characteristics

At a glance

[Link](#)  [hgpt](#)

Sturdy and precise kinematics for maximum torque resistance and long service life.

The force generated by the linear motion is translated into the gripper jaw movement via a wedge mechanism with force-guided motion. This also ensures that the gripper jaws move synchronously.

The plain-bearing guide is virtually backlash-free thanks to the ground-in gripper jaws.

Flexible range of applications:

- Can be used as a double-acting and single-acting gripper
- Compression spring for supporting or retaining the gripping forces
- Suitable for external and internal gripping
- Centring optionally via centring pins or centring sleeves

These grippers are not designed for the following or similar application examples:

- Welding spatter

These grippers are of limited suitability for the following application examples:

- Machining possible with sealing air
- Aggressive media: only possible after consultation with Festo

Engineering tools

[Link](#)  [engineering tools](#)



Save time with engineering tools: Smart engineering for the optimal solution. Our goal is to increase your productivity. Our engineering tools play an integral part in achieving this goal. They help you size your system correctly, tap into unimagined productivity reserves and generate additional productivity along the entire value chain. In every phase of your project, from the initial contact to the modernisation of your machine, you will come across a number of different tools that will be of use to you.

Gripper selection:

- This tool helps you to select the right grippers by simply entering the exact parameters for your application

Diagrams

[Link](#)  [hgpt](#)



The diagrams shown in this document are also available online. These can be used to display precise values.

Position sensing

[A] For proximity sensor

By using proximity switches, any position can be detected.

Generation

[B] Function-optimised

Sturdy version with space-optimised design

Gripping force

[F] High

Increased gripping force with oval piston

Characteristics

Gripping force backup

[G1] Opening



Opened by spring force in depressurised state

[G2] Closing



Closed by spring force in depressurised state

Overview

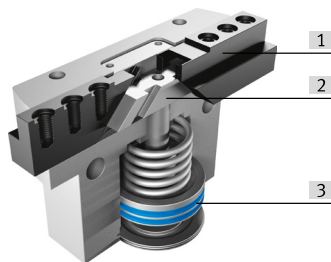

- [1] Gripper jaw
- [2] Wedge with forced-guided motion
- [3] Piston with magnet

Type code

001	Series	
HGPT	Parallel gripper, sturdy	

002	Size [mm]	
16	16	
20	20	
25	25	
35	35	
40	40	
50	50	
63	63	
80	80	

003	Position sensing	
A	For proximity sensor	

004	Generation	
B	Series B	

005	Gripping force	
	Standard	
F	High	

006	Gripping force backup	
	None	
G1	Opening	
G2	Closing	

Datasheet

General technical data																
Size	16		20		25		35		40		50		63		80	
Stroke per gripper jaws	1.5	3	2	4	3	6	4	8	5	10	6	12	8	16	12.5	25
Design	Wedge-shaped drive Force pilot operated motion sequence															
Drive system	Pneumatic															
Mode of operation	Double-acting															
Gripping force backup	None Opening Closing															
Gripper function	Parallel															
Number of gripper jaws	2															
Max. mass per external gripper finger ¹⁾	40 g		50 g		110 g		180 g		310 g		640 g		1,260 g		1,830 g	
Pneumatic connection ²⁾	M5	M3 M5	M5									G1/8		G1/4		
Pneumatic connection, blocked air	M3		M5													
Repetition accuracy, gripper ³⁾	≤0.03 mm		≤0.04 mm				≤0.05 mm									
Rotationally symmetrical	≤0.2 mm															
Max. replacement accuracy	≤0.2 mm															
Max. operating frequency of gripper	≤3 Hz								≤2 Hz							
Position detection	Via proximity switch															
Type of mounting	Either: Via female thread and centring sleeve Via through-hole and centring sleeve Via through-hole and dowel pin Via female thread and dowel pin															
Mounting position	optional															

1) Applies to unthrottled operation

2) HGPT-16-...: M5

HGPT-16-...-G1: M3

3) End-position drift under constant operating conditions with 100 consecutive strokes in the direction of movement of the gripper jaws

Operating and environmental conditions																
Size	16		20		25		35		40		50		63		80	
Operating medium	Compressed air to ISO 8573-1:2010 [7:4:4]															
Note on operating and pilot medium	Lubricated operation possible (in which case lubricated operation will always be required)															
Ambient temperature ¹⁾	5 ... 60°C															
Degree of protection	IP40															
Corrosion resistance class CRC ²⁾	2 - Moderate corrosion stress															
Lubrication interval for guide components	5 MioCyc															

1) Note the operating range of the proximity switches

2) More information: www.festo.com/x/topic/crc

Operating pressure – HGPD-16 ... 35																
Size	16				20				25				35			
Gripping force backup	None	Opening	Closing		None	Opening	Closing		None	Opening	Closing		None	Opening	Closing	
Operating pressure	3 ... 8 bar		4 ... 8 bar		3 ... 8 bar		4 ... 8 bar		3 ... 8 bar		4 ... 8 bar		3 ... 8 bar		4 ... 8 bar	
Operating pressure of blocked air	0 ... 0.5 bar															

Operating pressure – HGPT-40 ... 80																
Size	40				50				63				80			
Gripping force backup	None	Opening	Closing		None	Opening	Closing		None	Opening	Closing		None	Opening	Closing	
Operating pressure	3 ... 8 bar		4 ... 8 bar		3 ... 8 bar		4 ... 8 bar		3 ... 8 bar		4 ... 8 bar		3 ... 8 bar		4 ... 8 bar	
Operating pressure of blocked air	0 ... 0.5 bar															

Datasheet

Weight – HGPT-16 ... 35

Size	16			20			25			35		
Gripping force backup	None	Opening	Closing	None	Opening	Closing	None	Opening	Closing	None	Opening	Closing
Product weight	85 g	100 g		135 g	155 g		266 g	353 g		490 g	567 g	

Weight – HGPT-40 ... 80

Size	40			50			63			80		
Gripping force backup	None	Opening	Closing	None	Opening	Closing	None	Opening	Closing	None	Opening	Closing
Product weight	821 g	1,075 g		1,400 g	1,832 g		2,712 g	3,562 g		4,745 g	6,287 g	

Materials

Size	16	20	25	35	40	50	63	80
Material housing	Anodised aluminium							
Material gripper jaws	Hardened steel							
Material cover cap	High-alloy stainless steel							
Note on materials	RoHS-compliant							
LABS (PWIS) conformity	VDMA24364-B1/B2-L							

Measured gripping force with a lever arm of 20 mm – HGPT-16 ... 35

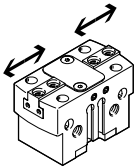

Size	16		20		25		35	
Stroke per gripper jaws	1.5	3	2	4	3	6	4	8
Total gripping force, closing, 0.6MPa (6bar, 87 psi)	192 N	106 N	322 N	154 N	442 N	248 N	934 N	458 N
Total gripping force, opening, 0.6MPa (6bar, 87 psi)	216 N	120 N	344 N	162 N	476 N	266 N	1,000 N	490 N
Gripper force per gripper jaw, closing, 0.6 MPa (6 bar, 87 psi)	96 N	53 N	161 N	77 N	221 N	124 N	467 N	229 N
Gripper force per gripper jaw, opening, 0.6 MPa (6 bar, 87 psi)	108 N	60 N	172 N	82 N	238 N	133 N	500 N	245 N

Measured gripping force with a lever arm of 20 mm – HGPT-40 ... 80

Size	40		50		63		80	
Stroke per gripper jaws	5	10	6	12	8	16	12.5	25
Total gripping force, closing, 0.6MPa (6bar, 87 psi)	1,328 N	662 N	2,226 N	1,070 N	3,522 N	1,702 N	6,300 N	3,102 N
Total gripping force, opening, 0.6MPa (6bar, 87 psi)	1,446 N	710 N	2,370 N	1,140 N	3,770 N	1,792 N	6,550 N	3,226 N
Gripper force per gripper jaw, closing, 0.6 MPa (6 bar, 87 psi)	674 N	331 N	1,113 N	535 N	1,791 N	851 N	3,150 N	1,551 N
Gripper force per gripper jaw, opening, 0.6 MPa (6 bar, 87 psi)	723 N	355 N	1,185 N	570 N	1,885 N	896 N	3,275 N	1,613 N

Datasheet

Characteristic load values at the gripper jaws

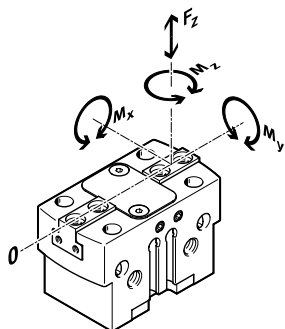

The indicated permissible forces and torques apply to a single gripper jaw. They include the lever arm, additional applied loads created by the workpiece or external gripper fingers and acceleration forces occurring during movement. The zero coordinate line (gripper jaw guide) must be taken into account when calculating torques.

Size	16	20	25	35	40	50	63	80
Max. force on gripper jaw F_z static	200 N	700 N	1,200 N	1,800 N	2,500 N	3,200 N	5,000 N	7,000 N
Max. torque at gripper M_x static	10 Nm	15 Nm	50 Nm	80 Nm	100 Nm	120 Nm	160 Nm	180 Nm
Max. torque at gripper M_y static	12 Nm	15 Nm	45 Nm	60 Nm	90 Nm	120 Nm	180 Nm	220 Nm
Max. torque at gripper M_z static	6 Nm	8 Nm	35 Nm	50 Nm	75 Nm	100 Nm	140 Nm	170 Nm

Gripping force FH per gripper jaw as a function of operating pressure and lever arm x – External gripping (closing)

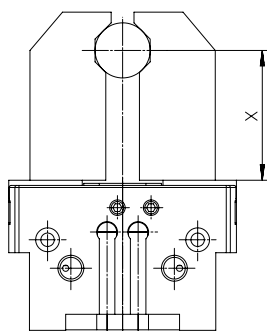

The gripping forces as a function of operating pressure and lever arm can be determined from the following graphs.

The gripping torque is not constant across the opening angle.

Sizing software for gripper selection → <https://www.festo.com/x/topic/eng>

Gripping force FH per gripper jaw as a function of operating pressure and lever arm x – External gripping (closing), double-acting, standard gripping force – HGPT-16-A-B

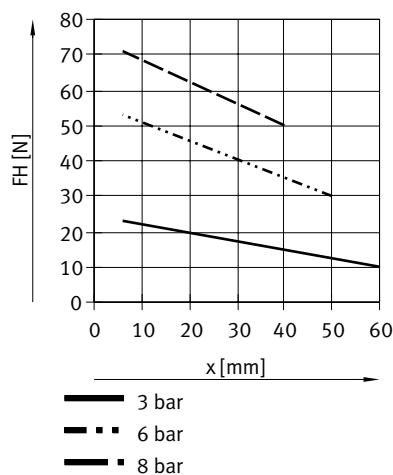

Datasheet

Gripping force FH per gripper jaw as a function of operating pressure and lever arm x – External gripping (closing), double-acting, standard gripping force – HGPT-20-A-B

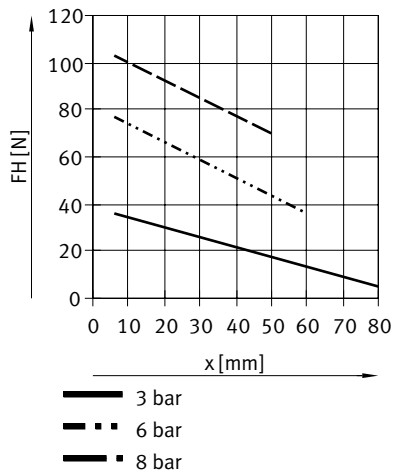

Gripping force FH per gripper jaw as a function of operating pressure and lever arm x – External gripping (closing), double-acting, standard gripping force – HGPT-25-A-B

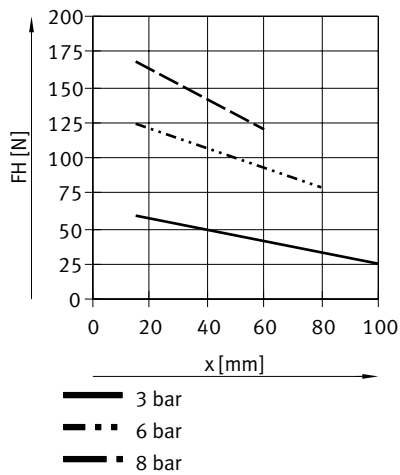

Datasheet

Gripping force FH per gripper jaw as a function of operating pressure and lever arm x – External gripping (closing), double-acting, standard gripping force – HGPT-35-A-B

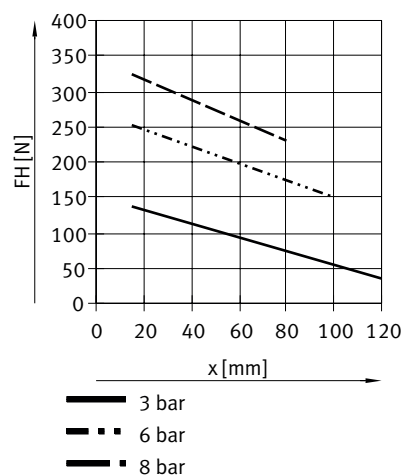

Gripping force FH per gripper jaw as a function of operating pressure and lever arm x – External gripping (closing), double-acting, standard gripping force – HGPT-40-A-B

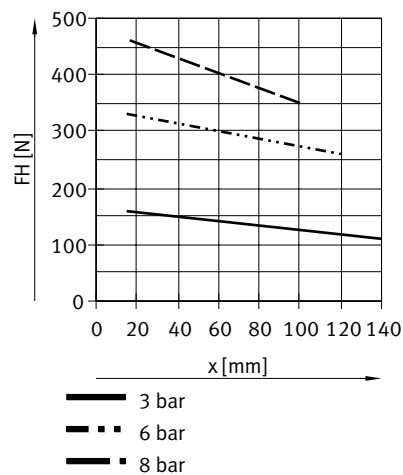

Datasheet

Gripping force FH per gripper jaw as a function of operating pressure and lever arm x – External gripping (closing), double-acting, standard gripping force – HGPT-50-A-B

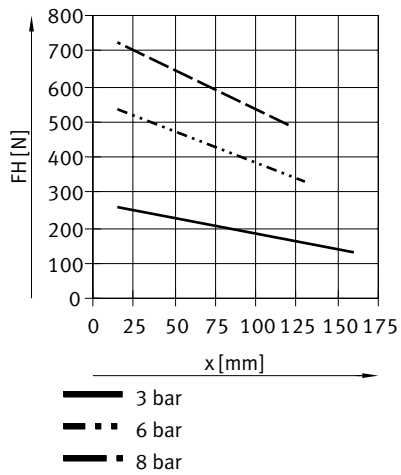

Gripping force FH per gripper jaw as a function of operating pressure and lever arm x – External gripping (closing), double-acting, standard gripping force – HGPT-63-A-B

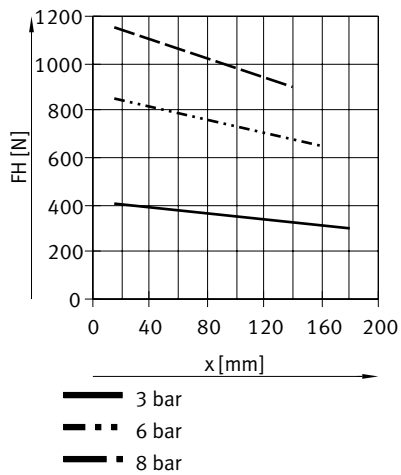

Datasheet

Gripping force FH per gripper jaw as a function of operating pressure and lever arm x – External gripping (closing), double-acting, standard gripping force – HGPT-80-A-B

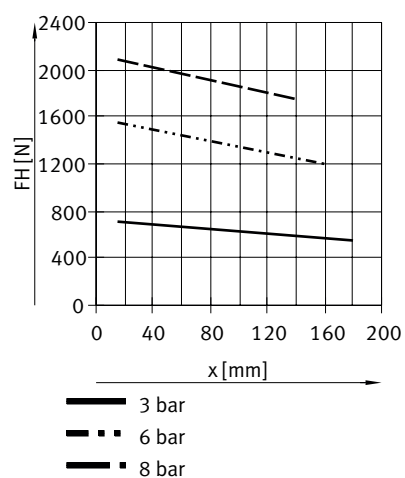

Gripping force FH per gripper jaw as a function of operating pressure and lever arm x – External gripping (closing), double-acting, high gripping force – HGPT-16-A-B-F

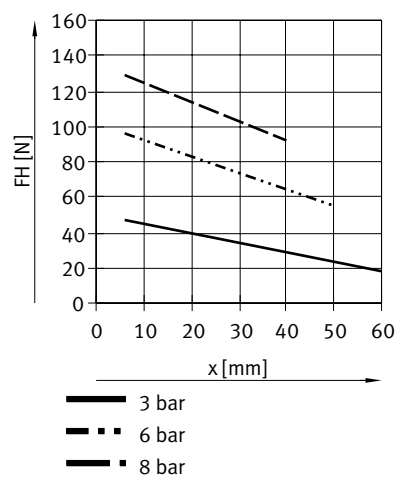

Datasheet

Gripping force FH per gripper jaw as a function of operating pressure and lever arm x – External gripping (closing), double-acting, high gripping force – HGPT-20-A-B-F

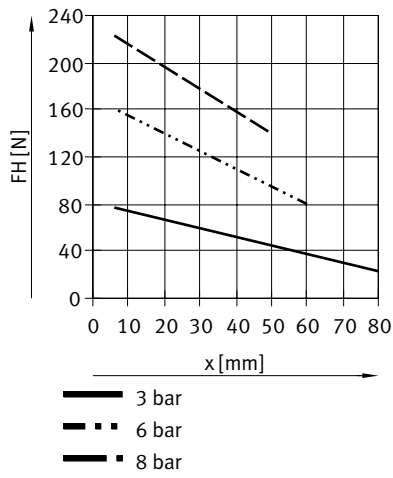

Gripping force FH per gripper jaw as a function of operating pressure and lever arm x – External gripping (closing), double-acting, high gripping force – HGPT-25-A-B-F

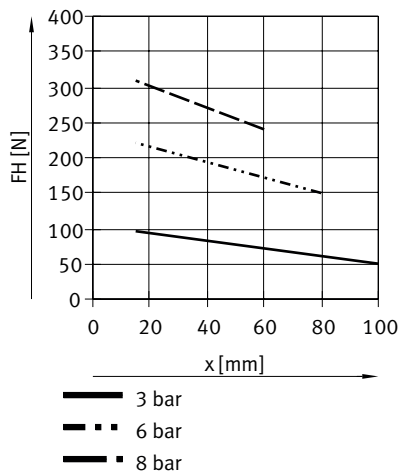

Datasheet

Gripping force FH per gripper jaw as a function of operating pressure and lever arm x – External gripping (closing), double-acting, high gripping force – HGPT-35-A-B-F

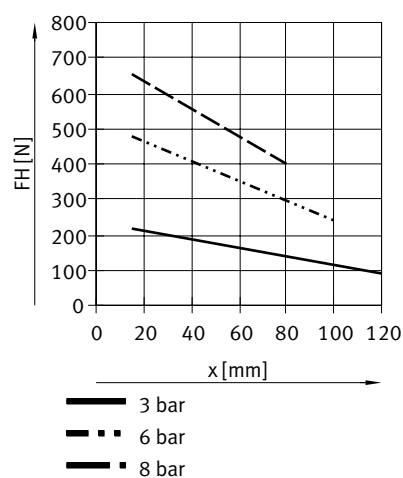

Gripping force FH per gripper jaw as a function of operating pressure and lever arm x – External gripping (closing), double-acting, high gripping force – HGPT-40-A-B-F

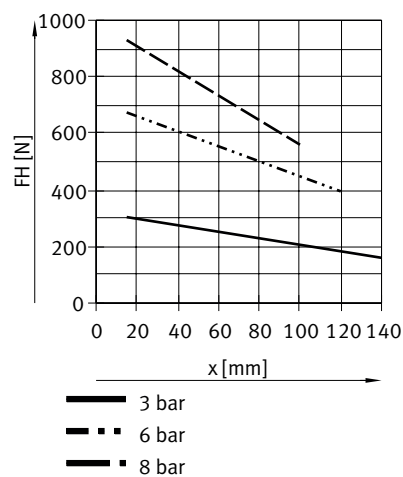

Datasheet

Gripping force FH per gripper jaw as a function of operating pressure and lever arm x – External gripping (closing), double-acting, high gripping force – HGPT-50-A-B-F

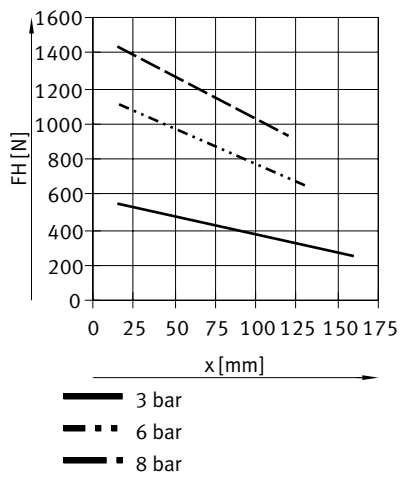

Gripping force FH per gripper jaw as a function of operating pressure and lever arm x – External gripping (closing), double-acting, high gripping force – HGPT-63-A-B-F

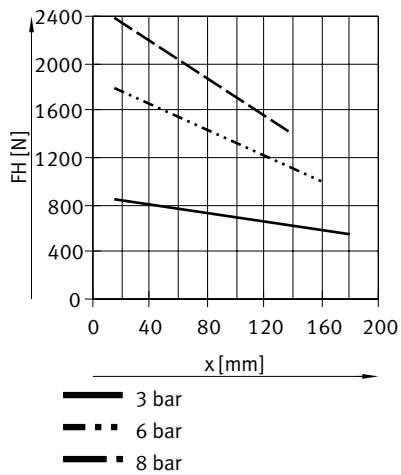

Datasheet

Gripping force FH per gripper jaw as a function of operating pressure and lever arm x – External gripping (closing), double-acting, high gripping force – HGPT-80-A-B-F

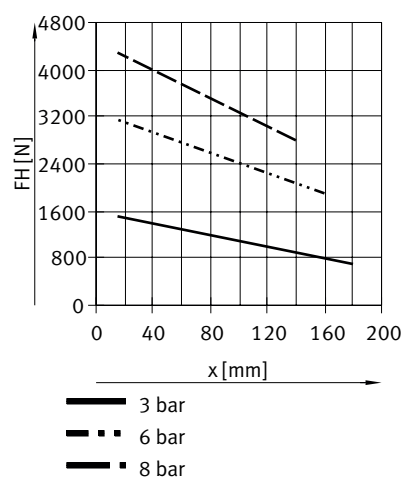

Gripping force FH per gripper jaw as a function of operating pressure and lever arm x – Internal gripping (opening)

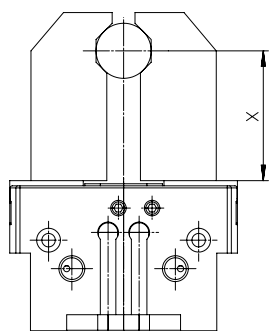

The gripping forces as a function of operating pressure and lever arm can be determined from the following graphs.

The gripping torque is not constant across the opening angle.

Sizing software for gripper selection → <https://www.festo.com/x/topic/eng>

Gripping force FH per gripper jaw as a function of operating pressure and lever arm x – Internal gripping (open), double-acting, standard gripping force – HGPT-16-A-B

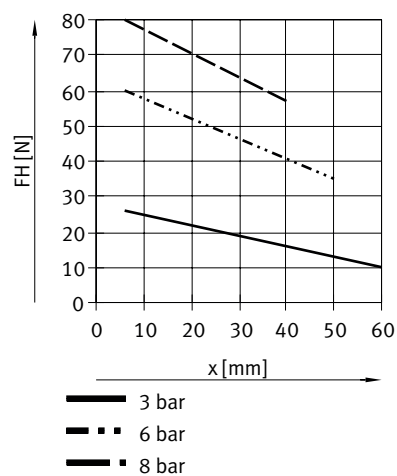

Datasheet

Gripping force FH per gripper jaw as a function of operating pressure and lever arm x – Internal gripping (open), double-acting, standard gripping force – HGPT-20-A-B

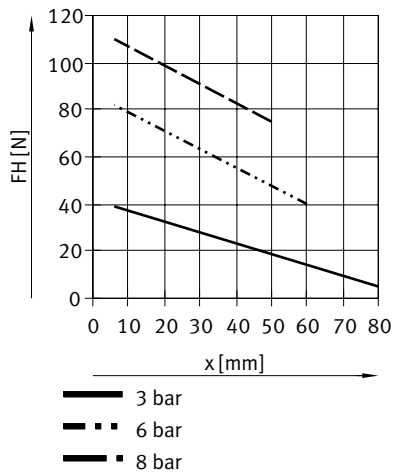

Gripping force FH per gripper jaw as a function of operating pressure and lever arm x – Internal gripping (open), double-acting, standard gripping force – HGPT-25-A-B

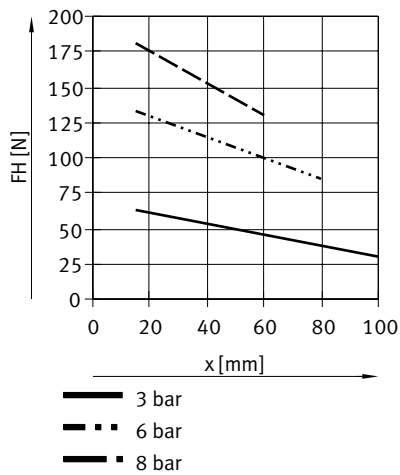

Datasheet

Gripping force F_H per gripper jaw as a function of operating pressure and lever arm x – Internal gripping (open), double-acting, standard gripping force – HGPT-35-A-B

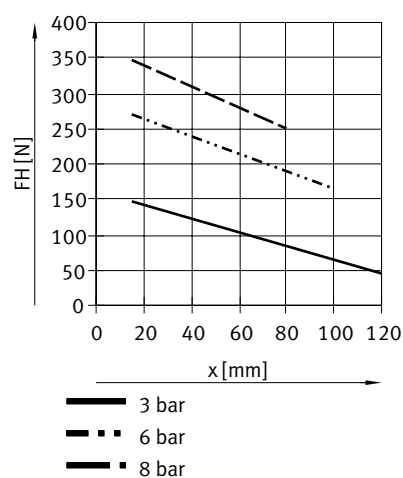

Gripping force F_H per gripper jaw as a function of operating pressure and lever arm x – Internal gripping (open), double-acting, standard gripping force – HGPT-40-A-B

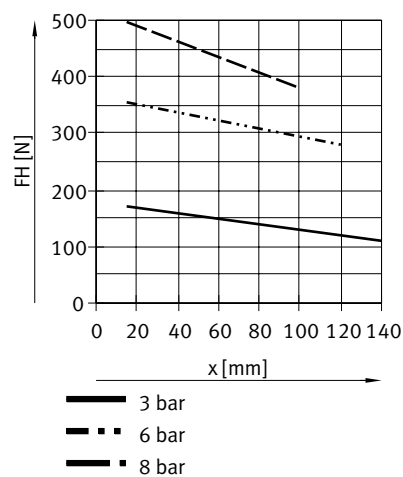

Datasheet

Gripping force FH per gripper jaw as a function of operating pressure and lever arm x – Internal gripping (open), double-acting, standard gripping force – HGPT-50-A-B

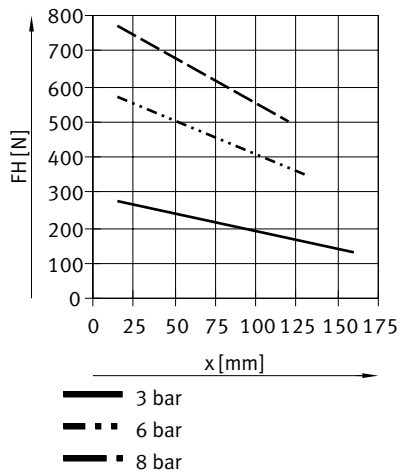

Gripping force FH per gripper jaw as a function of operating pressure and lever arm x – Internal gripping (open), double-acting, standard gripping force – HGPT-63-A-B

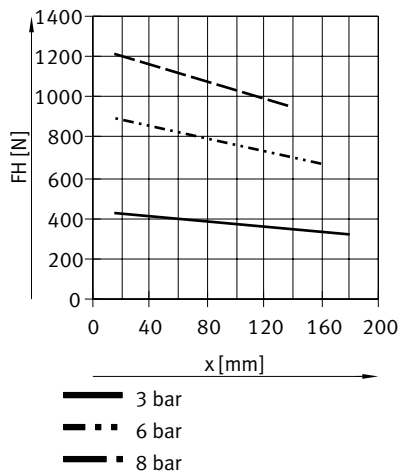

Datasheet

Gripping force F_H per gripper jaw as a function of operating pressure and lever arm x – Internal gripping (open), double-acting, standard gripping force – HGPT-80-A-B

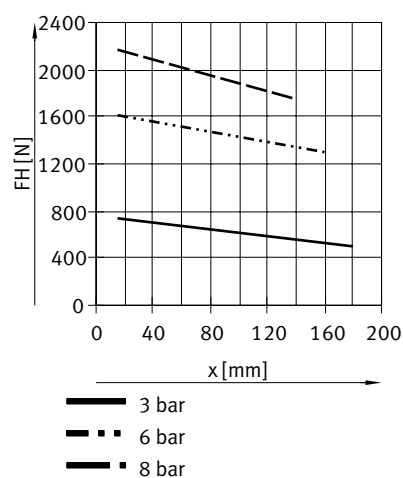

Gripping force F_H per gripper jaw as a function of operating pressure and lever arm x – Internal gripping (open), double-acting, high gripping force – HGPT-16-A-B-F

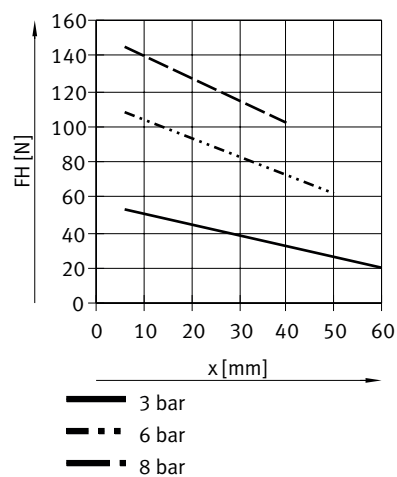

Datasheet

Gripping force FH per gripper jaw as a function of operating pressure and lever arm x – Internal gripping (open), double-acting, high gripping force – HGPT-20-A-B-F

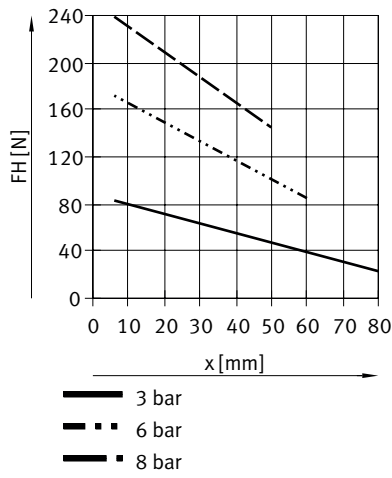

Gripping force FH per gripper jaw as a function of operating pressure and lever arm x – Internal gripping (open), double-acting, high gripping force – HGPT-25-A-B-F

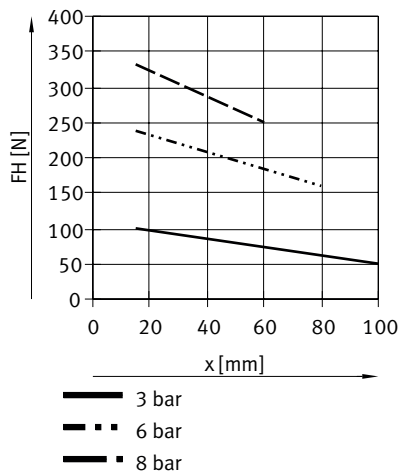

Datasheet

Gripping force FH per gripper jaw as a function of operating pressure and lever arm x – Internal gripping (open), double-acting, high gripping force – HGPT-35-A-B-F

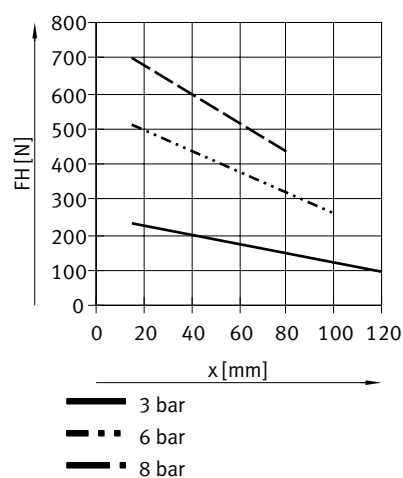

Gripping force FH per gripper jaw as a function of operating pressure and lever arm x – Internal gripping (open), double-acting, high gripping force – HGPT-40-A-B-F

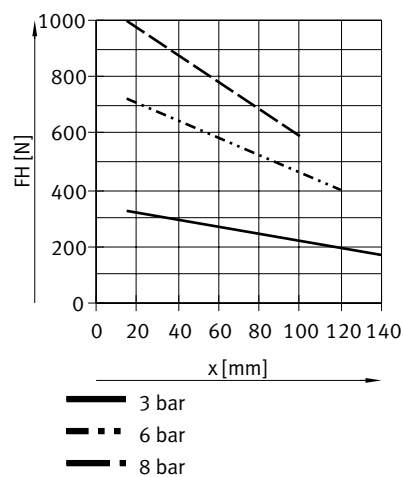

Datasheet

Gripping force FH per gripper jaw as a function of operating pressure and lever arm x – Internal gripping (open), double-acting, high gripping force – HGPT-50-A-B-F

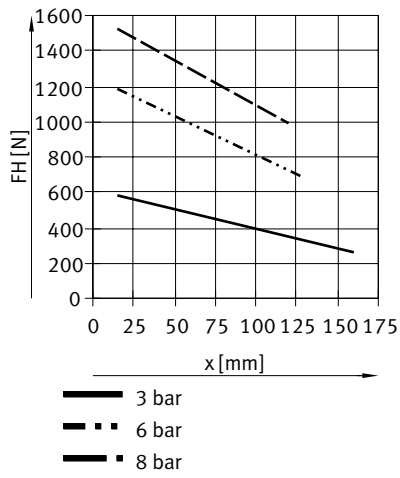

Gripping force FH per gripper jaw as a function of operating pressure and lever arm x – Internal gripping (open), double-acting, high gripping force – HGPT-63-A-B-F

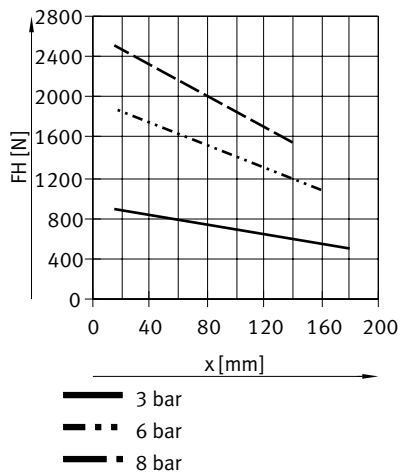

Datasheet

Gripping force FH per gripper jaw as a function of operating pressure and lever arm x – Internal gripping (open), double-acting, high gripping force – HGPT-80-A-B-F

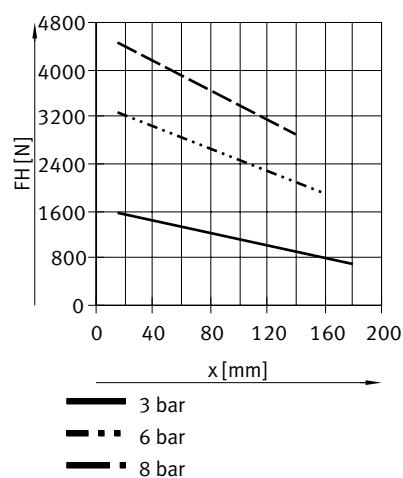

Gripping force FH per gripper jaw at 0.6 MPa (6 bar, 87 psi) as a function of lever arm x and eccentricity a and b

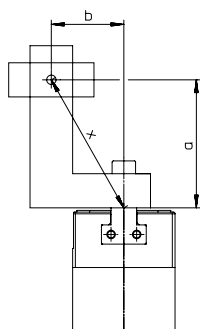

Gripping force FH per gripper jaw at 0.6 MPa (6 bar, 87 psi) as a function of lever arm x and eccentricity a and b

$$x = \sqrt{a^2 + b^2} = \sqrt{45^2 + 40^2} = 60 \text{ mm}$$

The formula (on the left) must be used to calculate the lever arm x with eccentric gripping.

The gripping force FH can then be read from the graphs using the calculated value x.

Calculation example:

Assuming:

Distance a = 45 mm

Distance b = 40 mm

To be determined:

The gripping force at 6 bar with an HGPT-25, used as an external gripper.

Datasheet

Gripping force FH per gripper jaw at 0.6 MPa (6 bar, 87 psi) as a function of lever arm x and eccentricity a and b

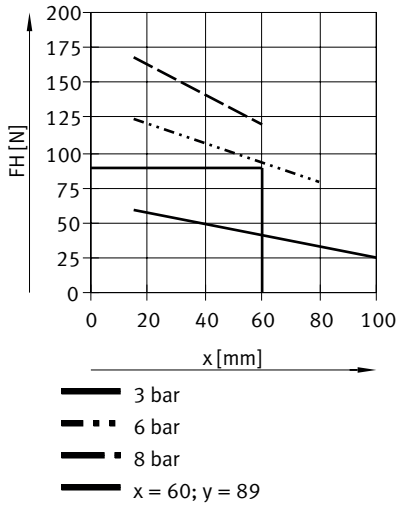

The graph gives a value of FH = 89 N for the gripping force.

Spring force FF as a function of size and gripper jaw stroke l – with gripping force retention

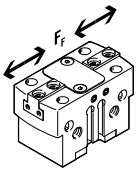

The spring forces FF as a function of the gripper jaw stroke l can be determined from the following graph.

Sizing software for gripper selection → <https://www.festo.com/x/topic/eng>

Spring force FF as a function of size and gripper jaw stroke l – With gripping force retention, standard gripping force – HGPT-16 ... 35-A-B-G

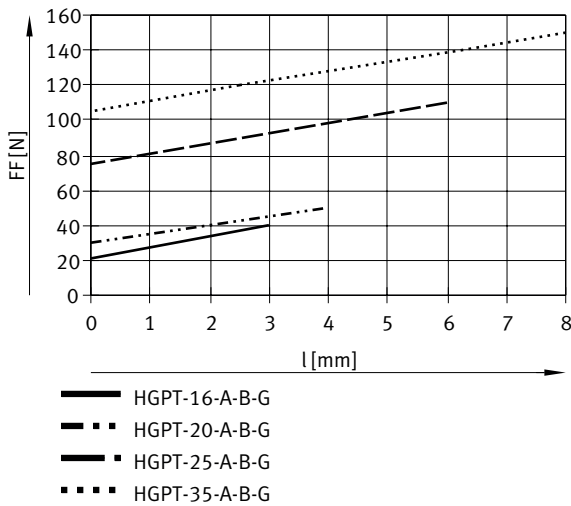

Datasheet

Spring force FF as a function of size and gripper jaw stroke l – With gripping force retention, standard gripping force – HGPT-40 ... 80-A-B-G

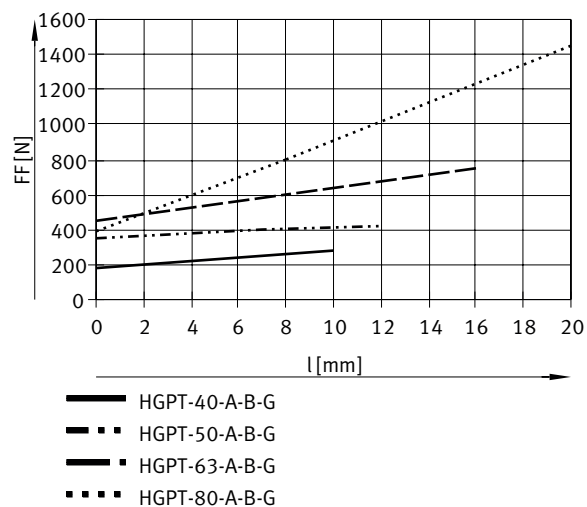

Spring force FF as a function of size and gripper jaw stroke l – With gripping force retention, high gripping force – HGPT-16 ... 35-A-B-F-G

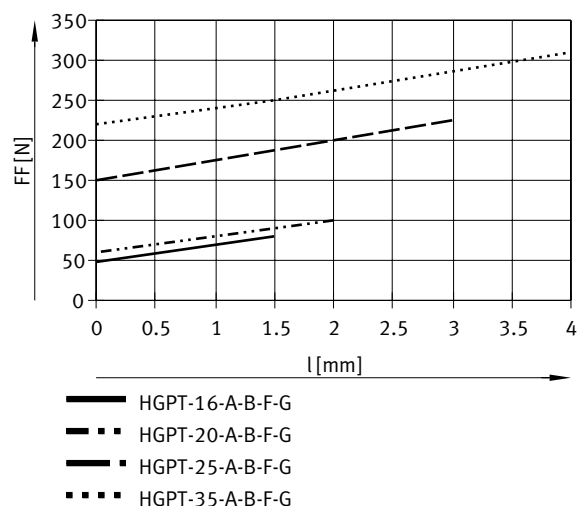

Datasheet

Spring force FF as a function of size and gripper jaw stroke l – With gripping force retention, high gripping force – HGPT-40 ... 80-A-B-F-G

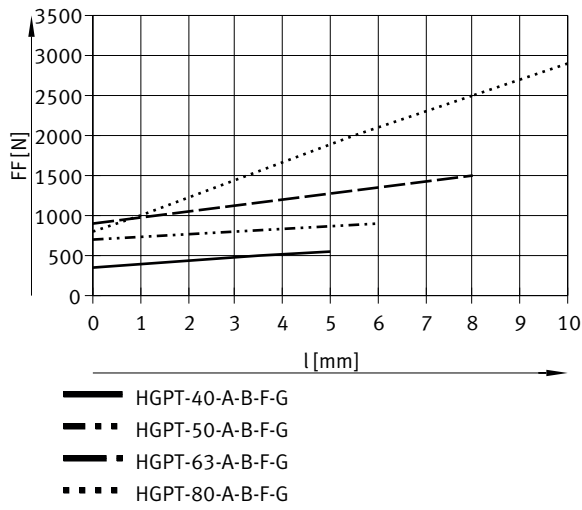

Datasheet

Spring force FF as a function of size, gripper jaw stroke l and lever arm x per gripper finger

To determine the actual spring force FFtot, the lever arm x must be taken into account.

Formulas for calculating the spring force FFtot per gripper finger:

Standard, opening - HGPT-...-A-B-G1:

HGPT-16-...-A-B-G1: $-0.1 * x + 0.7 * FF$
 HGPT-20-...-A-B-G1: $-0.05 * x + 0.9 * FF$
 HGPT-25-...-A-B-G1: $-0.7 * x + 0.7 * FF$
 HGPT-35-...-A-B-G1: $-0.65 * x + 0.7 * FF$
 HGPT-40-...-A-B-G1: $-1.05 * x + 0.8 * FF$
 HGPT-50-...-A-B-G1: $-0.75 * x + 0.8 * FF$
 HGPT-63-...-A-B-G1: $-2 * x + 0.8 * FF$
 HGPT-80-...-A-B-G1: $-1.4 * x + 0.6 * FF$

High force, opening – HGPT-...-A-B-F-G1:

HGPT-16-...-A-B-F-G1: $-0.6 * x + 0.6 * FF$
 HGPT-20-...-A-B-F-G1: $-0.7 * x + 0.75 * FF$
 HGPT-25-...-A-B-F-G1: $-0.85 * x + 0.9 * FF$
 HGPT-35-...-A-B-F-G1: $-0.4 * x + 0.55 * FF$
 HGPT-40-...-A-B-F-G1: $-1.9 * x + 0.75 * FF$
 HGPT-50-...-A-B-F-G1: $-2.5 * x + 0.7 * FF$
 HGPT-63-...-A-B-F-G1: $-5.5 * x + 0.7 * FF$
 HGPT-80-...-A-B-F-G1: $-5.65 * x + 0.8 * FF$

Standard, closing – HGPT-...-A-B-G2:

HGPT-16-...-A-B-G2: $-0.2 * x + 0.7 * FF$
 HGPT-20-...-A-B-G2: $-0.65 * x + 0.9 * FF$
 HGPT-25-...-A-B-G2: $-0.55 * x + 0.7 * FF$
 HGPT-35-...-A-B-G2: $-0.05 * x + 0.7 * FF$
 HGPT-40-...-A-B-G2: $-1.05 * x + 0.8 * FF$
 HGPT-50-...-A-B-G2: $-1.4 * x + 0.8 * FF$
 HGPT-63-...-A-B-G2: $-1.2 * x + 0.8 * FF$
 HGPT-80-...-A-B-G2: $-0.6 * x + 0.6 * FF$

High force, closing – HGPT-...-A-B-F-G2:

HGPT-16-...-A-B-F-G2: $-0.4 * x + 0.6 * FF$
 HGPT-20-...-A-B-F-G2: $-0.95 * x + 0.75 * FF$
 HGPT-25-...-A-B-F-G2: $-0.5 * x + 0.9 * FF$
 HGPT-35-...-A-B-F-G2: $-0.4 * x + 0.55 * FF$
 HGPT-40-...-A-B-F-G2: $-2.3 * x + 0.75 * FF$
 HGPT-50-...-A-B-F-G2: $-1 * x + 0.7 * FF$
 HGPT-63-...-A-B-F-G2: $-1 * x + 0.7 * FF$
 HGPT-80-...-A-B-F-G2: $-0.5 * x + 0.8 * FF$

Determining the actual gripping forces FGr for HGPT-...-G1 and HGPT-...-G2 as a function of the application

The parallel grippers with integrated spring type HGPT-...-G1 (opening gripping force retention) and HGPT-...-G2 (closing gripping force backup) can be used as:

- Single-acting grippers
- Gripper with gripping force support and
- Grippers with gripping force retention

To calculate available gripping forces FGr (per gripper jaw), the data for gripping force FH and spring force FFtot must be combined accordingly.

Datasheet

Determining the actual gripping forces F_{Gr} for HGPT-...-G1 and HGPT-...-G2 as a function of the application – application

Single-acting:

- Gripping with spring force: $F_{Gr} = F_{Ftot}$
- Gripping with pressure force: $F_{Gr} = F_H - F_{Ftot}$

Gripping force support:

- Gripping with pressure and spring force: $F_{Gr} = F_H + F_{Ftot}$

Gripping force retention

- Gripping with spring force: $F_{Gr} = F_{Ftot}$

Mass moments of inertia

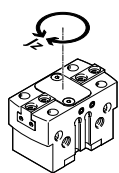

Mass moment of inertia of the grippers in relation to the central axis, without external gripper fingers, without load.

Mass moments of inertia – HGPT-16 ... 35

Size	16			20			25			35		
Gripping force backup	None	Opening	Closing	None	Opening	Closing	None	Opening	Closing	None	Opening	Closing
Mass moment of inertia	0.141 kg-cm ²	0.163 kgcm ²		0.344 kg-cm ²	0.445 kgcm ²		0.983 kg-cm ²	1.479 kgcm ²		2.807 kg-cm ²	3.974 kgcm ²	

Mass moments of inertia – HGPT-40 ... 80

Size	40			50			63			80		
Gripping force backup	None	Opening	Closing	None	Opening	Closing	None	Opening	Closing	None	Opening	Closing
Mass moment of inertia	7.277 kg-cm ²	10.99 kgcm ²		19.488 kgcm ²	29.423 kgcm ²		60.903 kgcm ²	93.034 kgcm ²		150.515 kgcm ²	238.336 kgcm ²	

Gripper jaw backlash

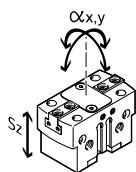

The plain-bearing guide used in the grippers means that there is backlash between the gripper jaws and the housing. The values listed in the table apply in new condition.

Size	16	20	25	35	40	50	63	80
Max. gripper jaw backlash S_z ¹⁾	≤0.02 mm							
Max. angular gripper jaw backlash α_x, α_y ²⁾	≤0.1 deg							

1) The values only apply when the gripper is open.

2) The values only apply when the gripper is open.

Datasheet

Opening and closing times – HGPT-16 ... 20

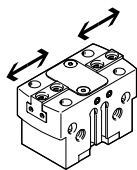

The indicated opening and closing times were measured at room temperature at an operating pressure of 0.6 MPa (6 bar, 87 psi) with a horizontally mounted gripper without additional gripper fingers.

The grippers must be throttled for masses that are higher than the specified unthrottled maximum mass per external gripper finger. Opening and closing times must then be adjusted accordingly.

Size	16						20					
Stroke per gripper jaws	1.5			3			2			4		
Gripping force backup	None	Opening	Closing	None	Opening	Closing	None	Opening	Closing	None	Opening	Closing
Min. opening time at 0.6 MPa (6 bar, 87 psi)	8 ms	19 ms	33 ms	9 ms	13 ms	22 ms	28 ms	13 ms	38 ms	22 ms	13 ms	35 ms
Min. closing time at 0.6 MPa (6 bar, 87 psi)	10 ms	30 ms	17 ms	11 ms	31 ms	15 ms	31 ms	25 ms	14 ms	30 ms	25 ms	18 ms

Opening and closing times – HGPT-25 ... 35

Size	25						35					
Stroke per gripper jaws	3			6			4			8		
Gripping force backup	None	Opening	Closing	None	Opening	Closing	None	Opening	Closing	None	Opening	Closing
Min. opening time at 0.6 MPa (6 bar, 87 psi)	25 ms	24 ms	36 ms	26 ms	24 ms	40 ms	33 ms	35 ms	63 ms	36 ms	37 ms	69 ms
Min. closing time at 0.6 MPa (6 bar, 87 psi)	32 ms	45 ms	28 ms	32 ms	48 ms	28 ms	70 ms	115 ms	72 ms	67 ms	114 ms	87 ms

Opening and closing times – HGPT-40 ... 50

Size	40						50					
Stroke per gripper jaws	5			10			6			12		
Gripping force backup	None	Opening	Closing	None	Opening	Closing	None	Opening	Closing	None	Opening	Closing
Min. opening time at 0.6 MPa (6 bar, 87 psi)	60 ms	71 ms	120 ms	56 ms	67 ms	122 ms	83 ms	70 ms	137 ms	80 ms	70 ms	151 ms
Min. closing time at 0.6 MPa (6 bar, 87 psi)	64 ms	143 ms	72 ms	60 ms	135 ms	71 ms	82 ms	143 ms	80 ms	85 ms	153 ms	77 ms

Opening and closing times – HGPT-63 ... 80

Size	63						80					
Stroke per gripper jaws	8			16			12.5			25		
Gripping force backup	None	Opening	Closing	None	Opening	Closing	None	Opening	Closing	None	Opening	Closing
Min. opening time at 0.6 MPa (6 bar, 87 psi)	143 ms	145 ms	308 ms	150 ms	146 ms	294 ms	212 ms	180 ms	362 ms	214 ms	182 ms	379 ms
Min. closing time at 0.6 MPa (6 bar, 87 psi)	152 ms	315 ms	154 ms	156 ms	328 ms	185 ms	211 ms	340 ms	178 ms	213 ms	353 ms	176 ms

Datasheet

Opening and closing times as a function of gripper finger mass – HGPT-16 ... 25

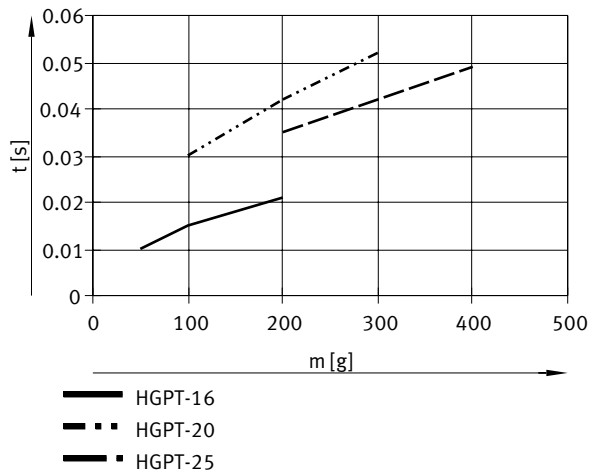

Opening and closing times as a function of gripper finger mass – HGPT-35 ... 50

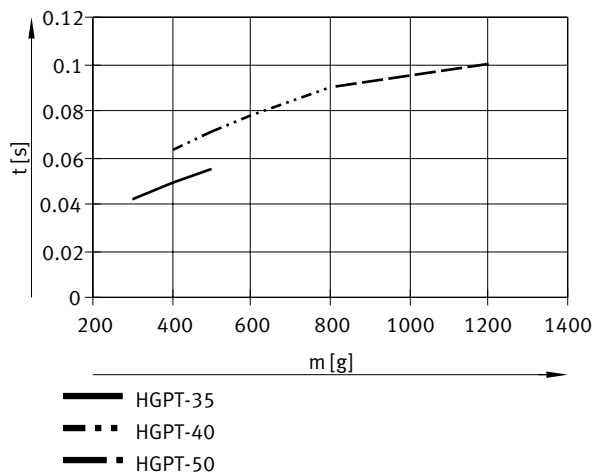

Opening and closing times as a function of gripper finger mass – HGPT-63 ... 80

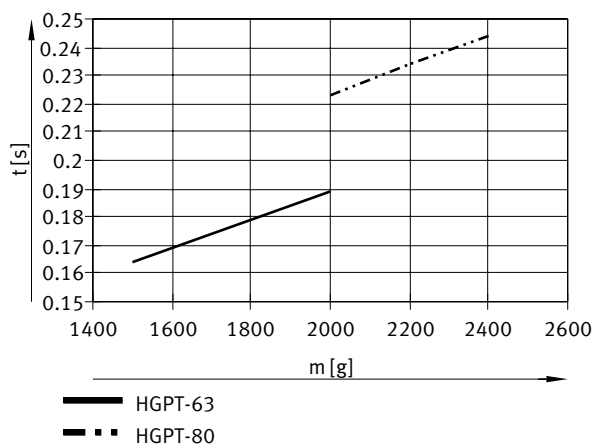

Dimensions

Dimensions – Parallel gripper HGPT

Download CAD data www.festo.com

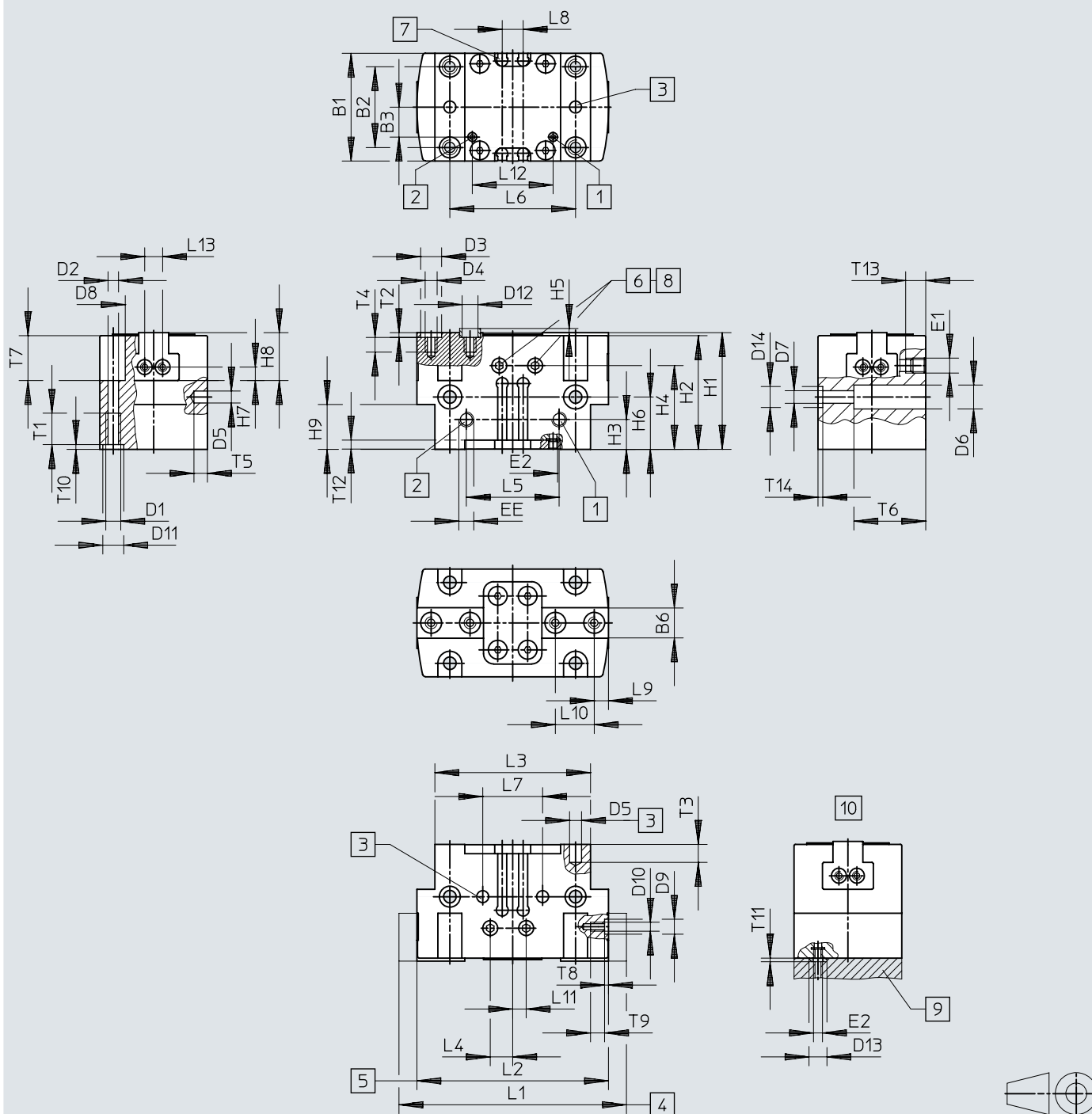

- [1] Compressed air connection opening, either on the side or underneath (delivery status: connection underneath sealed)
- [2] Compressed air connection closing, either at the side or underneath (delivery status: connection underneath sealed)
- [3] Drilled hole for dowel pin (not included in the scope of delivery)
- [4] Gripper jaws open
- [5] Gripper jaws closed
- [6] Sealing air connection (sealed on delivery)
- [7] Slot for proximity switch
- [8] Lubrication nipple (sealed on delivery)
- [9] O-ring for parallel gripper HGPT-16 ... 40: Ø 3x1.5 / HGPT-50 ... 80: Ø 5x1.5
- [10] Compressed air supply underneath

Dimensions

	B1 ±0,05	B2 ¹⁾	B3 ±0,1	B6 -0,05 -0,1	D1	D2 ∅	D3 ∅ H8/h7	D4	D5 ∅ H8	D6 ∅ ±0,1	D7 ∅	D8 ∅ +0,1	D9 ∅ H8	D10	D11 ∅ H8	D12 ∅
HGPT-16	24	17	4	6	M3	2,6	5	M3	2	4,6	2,6	4,6	-	M2	5	3,2
HGPT-20 ²⁾	28	22	8,7	6,5	M4	3,3	5	M3	3	6	3,2	6	5	M3	5	3,2
HGPT-25	36	27	11	10	M5	4,2	7	M4	4	8	4,2	8	5	M3	7	5,3
HGPT-35	42	32	13	12	M5	4,2	9	M5	4	9,2	5,3	8	7	M5	7	6,4
HGPT-40	50	38	17	14	M6	5,1	9	M6	5	11	6,4	9	7	M5	9	6,4
HGPT-50	60	45	20	15,5	M8	6,8	9	M6	6	13,5	8,4	11	7	M5	12	6,4
HGPT-63	72	56	24,5	20	M8	6,8	12	M10	6	13,5	8,4	11	7	M5	12	10,3
HGPT-80	100	70	39,5	22	M10	8,5	15	M12	8	16,5	10,2	13,5	9	M6	12	12,4

	D13 ∅	D14 ∅ H8	EE	E1	E2	H1		H2		H3		H4		H5 -0,3	H6 ¹⁾	
						±0,05	[G...] ±0,05	±0,05	[G...] ±0,05	±0,1	[G...] ±0,1		[G...]			[G...]
HGPT-16	6	-	M5	M3	M3	29	37	28	36	12	12	23,7	31,7	1,2	17,5	25,5
HGPT-20	6	-	M5	M3	M3	31	38	30	37	10	15	23	30	1,2	14,5	21,5
HGPT-25	6	7	M5	M5	M3	39	57	38	56	10	20	28	46	1,4	17,5	35,5
HGPT-35	6	7	M5	M5	M3	49	67	48	66	12	30	36	54	1,9	20	38
HGPT-40	6	9	M5	M5	M3	55	81	54	80	15	36	41	67	1,9	25	51
HGPT-50	8	12	G1/8	M5	M5	63	93	62	92	15	30	47	77	1,9	30	60
HGPT-63	8	12	G1/8	M5	M5	77	117	76	116	18	26	56	96	2,4	28	68
HGPT-80	8	12	G1/4	M5	M5	91	133	90	132	22	33	65	107	2,9	34	76

	H7 ¹⁾	H8 -0,02	H9		L1		L2 ±0,5	L3 ±0,1	L4 ±0,5	L5 ±0,1	L6 ¹⁾	L7 ¹⁾	L8 +0,1	L9 ¹⁾	L10 ¹⁾	L11 ±0,5
			±0,1	[G...] ±0,1	±0,5	[F] ±0,5										
HGPT-16	2,25	8,5	15	23	50	47	44	36	5,5	20	29	20	6	3	8	1
HGPT-20	3	12	15	22	64	60	56	44	5	24	35	24	6	3,25	12	2,5
HGPT-25	4,5	16	15	33	76	70	64	52	5,5	31	42	20	7	4,75	13	5,5
HGPT-35	5,5	19	20	38	96	88	80	64	5,5	40	52	40	7	5,5	16	5,5
HGPT-40	5,5	22	24	50	120	110	100	80	5,5	49	66	50	10	6,5	20	5,5
HGPT-50	7,5	25,5	26	56	149	137	125	100	5,5	63	82	60	10	8	24	5,5
HGPT-63	9	32	32	72	192	176	160	125	5,5	74	100	76	10	9,5	32	5,5
HGPT-80	11	39	34	77	230	205	180	154	5,5	82	130	100	10	12	40	5,5

	L12 ±0,1	L13 ¹⁾	T1 min.	T2 +0,1	T3 min.	T4 min.	T5 min.	T6	T7		T8 +0,1	T9	T10 +0,1	T11	T12 min.	T13 min.	T14 +0,1
									+0,2	[G...] +0,2							
HGPT-16	22	6	5,5	1,3	4	5	4	15	14	22	-	3	1,3	1,2	3	5,5	-
HGPT-20	22,6	6	6,5	1,3	5	5,5	4	19	11	11	1,3	6	1,3	1,2	3	5,5	-
HGPT-25	29	6	8,5	1,6	6	6,5	4,5	24	15	15	1,3	6	1,6	1,2	3	6,7	1,6
HGPT-35	39	13	8,5	2,1	6	8,5	4,5	16	19	19	1,6	9	1,6	1,2	3	6,5	1,6
HGPT-40	47,4	13	10,5	2,1	6	10,5	6	33	20	20	1,6	9	2,1	1,2	4	6,5	2,1
HGPT-50	61	13	12,5	2,1	8	10,5	6	43	23	23	1,6	9	2,6	1,2	4	6,5	2,6
HGPT-63	75	13	12,5	2,6	8	15,5	7	55	35	35	1,6	9	2,6	1,2	5	6,5	2,6
HGPT-80	82	20	15	3,1	10	20	10	70	44	44	2,1	10	2,6	1,2	5,5	5	2,6

- 1) Tolerance for centring hole ±0.02 mm Tolerance for thread ±0.1 mm
- 2) Dowel pins must be used when mounted from below.

Dimensions

Dimensions – Gripper jaw blank BUB-HGPT-16 ... 40

Download CAD data www.festo.com



	B1	B2	D1 ∅	D2 ∅	H1	L1	L2 ¹⁾	L3 ¹⁾	T1	T2
	±0,05	H13	H13	H8	±0,05	±0,05			+0,1	
BUB-HGPT-16	16	6	3,2	5	40	21	10	8	1,3	35
BUB-HGPT-20	19	6	3,2	5	45	27	11,75	12	1,3	36
BUB-HGPT-25	24	8	4,3	7	60	31	13,25	13	1,6	51
BUB-HGPT-35	28	10	5,3	9	70	39	17,5	16	2,1	61
BUB-HGPT-40	34	11	6,4	9	75	49	22,5	20	2,1	66,5

1) Tolerance for centring hole ±0.02 mm Tolerance for thread ±0.1 mm

Dimensions

Dimensions – Gripper jaw blank BUB-HGPT-50 ... 80

Download CAD data www.festo.com

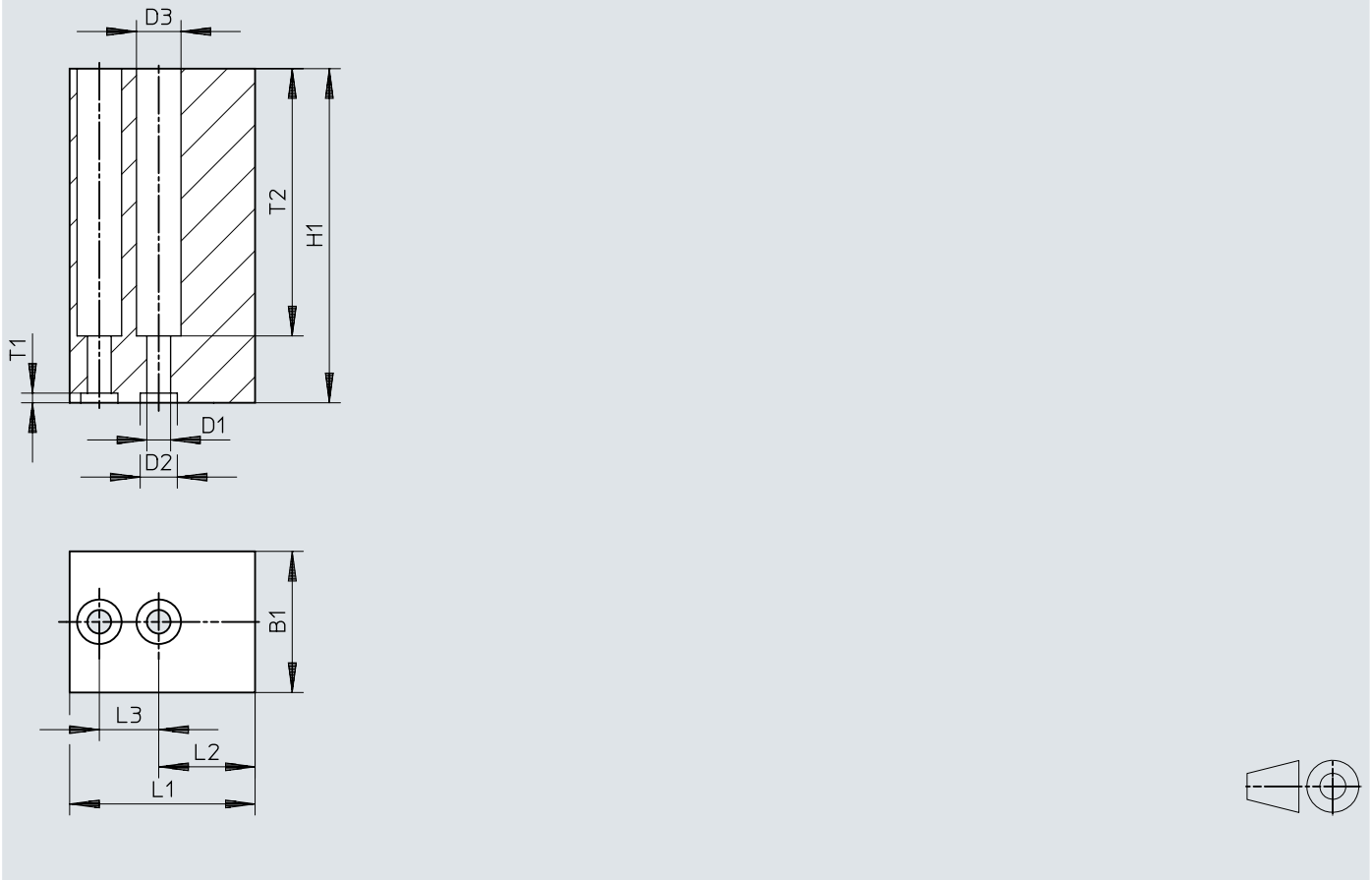

	B1	D1 ∅	D2 ∅	D3 ∅	H1	L1	L2 ¹⁾	L3 ¹⁾	T1	T2
	±0,05	H13	H8	H13	±0,05	±0,05			+0,1	
BUB-HGPT-50	40	6,4	9	11	100	61	29	24	2,1	91
BUB-HGPT-63	50	10,3	12	17	120	79	37,5	32	2,6	110
BUB-HGPT-80	58	12,4	15	20	140	88	36	40	3,1	125

1) Tolerance for centring hole ±0.02 mm Tolerance for thread ±0.1 mm

Ordering data

Double-acting, without compression spring						
	Size	Stroke per grip- per jaws	Gripping force	Product weight	Part no.	Type
	16	1.5 mm	High	85 g	560195	HGPT-16-A-B-F
		3 mm	Standard		560192	HGPT-16-A-B
	20	2 mm	High	135 g	560201	HGPT-20-A-B-F
		4 mm	Standard		560198	HGPT-20-A-B
	25	3 mm	High	266 g	560207	HGPT-25-A-B-F
		6 mm	Standard		560204	HGPT-25-A-B
	35	4 mm	High	490 g	560213	HGPT-35-A-B-F
		8 mm	Standard		560210	HGPT-35-A-B
	40	5 mm	High	821 g	560219	HGPT-40-A-B-F
		10 mm	Standard		560216	HGPT-40-A-B
	50	6 mm	High	1,400 g	560225	HGPT-50-A-B-F
		12 mm	Standard		560222	HGPT-50-A-B
	63	8 mm	High	2,712 g	560231	HGPT-63-A-B-F
		16 mm	Standard		560228	HGPT-63-A-B
80	12.5 mm	High	4,745 g	560237	HGPT-80-A-B-F	
	25 mm	Standard		560234	HGPT-80-A-B	

Single-acting or with gripping force retention, opening						
	Size	Stroke per grip- per jaws	Gripping force	Product weight	Part no.	Type
	16	1.5 mm	High	100 g	560196	HGPT-16-A-B-F-G1
		3 mm	Standard		560193	HGPT-16-A-B-G1
	20	2 mm	High	155 g	560202	HGPT-20-A-B-F-G1
		4 mm	Standard		560199	HGPT-20-A-B-G1
	25	3 mm	High	353 g	560208	HGPT-25-A-B-F-G1
		6 mm	Standard		560205	HGPT-25-A-B-G1
	35	4 mm	High	567 g	560214	HGPT-35-A-B-F-G1
		8 mm	Standard		560211	HGPT-35-A-B-G1
	40	5 mm	High	1,075 g	560220	HGPT-40-A-B-F-G1
		10 mm	Standard		560217	HGPT-40-A-B-G1
	50	6 mm	High	1,832 g	560226	HGPT-50-A-B-F-G1
		12 mm	Standard		560223	HGPT-50-A-B-G1
	63	8 mm	High	3,562 g	560232	HGPT-63-A-B-F-G1
		16 mm	Standard		560229	HGPT-63-A-B-G1
80	12.5 mm	High	6,287 g	560238	HGPT-80-A-B-F-G1	
	25 mm	Standard		560235	HGPT-80-A-B-G1	

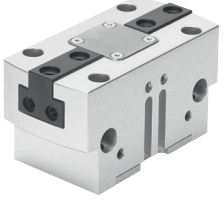
Single-acting or with gripping force retention, closing						
	Size	Stroke per grip- per jaws	Gripping force	Product weight	Part no.	Type
	16	1.5 mm	High	100 g	560197	HGPT-16-A-B-F-G2
		3 mm	Standard		560194	HGPT-16-A-B-G2
	20	2 mm	High	155 g	560203	HGPT-20-A-B-F-G2
		4 mm	Standard		560200	HGPT-20-A-B-G2
	25	3 mm	High	353 g	560209	HGPT-25-A-B-F-G2
		6 mm	Standard		560206	HGPT-25-A-B-G2
	35	4 mm	High	567 g	560215	HGPT-35-A-B-F-G2
		8 mm	Standard		560212	HGPT-35-A-B-G2
	40	5 mm	High	1,075 g	560221	HGPT-40-A-B-F-G2
		10 mm	Standard		560218	HGPT-40-A-B-G2
50	6 mm	High	1,832 g	560227	HGPT-50-A-B-F-G2	

Ordering data

Single-acting or with gripping force retention, closing

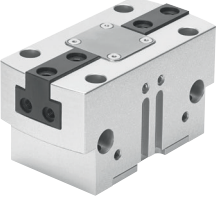
	Size	Stroke per gripper jaws	Gripping force	Product weight	Part no.	Type
	50	12 mm	Standard	1,832 g	560224	HGPT-50-A-B-G2
	63	8 mm	High	3,562 g	560233	HGPT-63-A-B-F-G2
		16 mm	Standard		560230	HGPT-63-A-B-G2
	80	12.5 mm	High	6,287 g	560239	HGPT-80-A-B-F-G2
		25 mm	Standard		560236	HGPT-80-A-B-G2

Peripherals

Peripherals overview

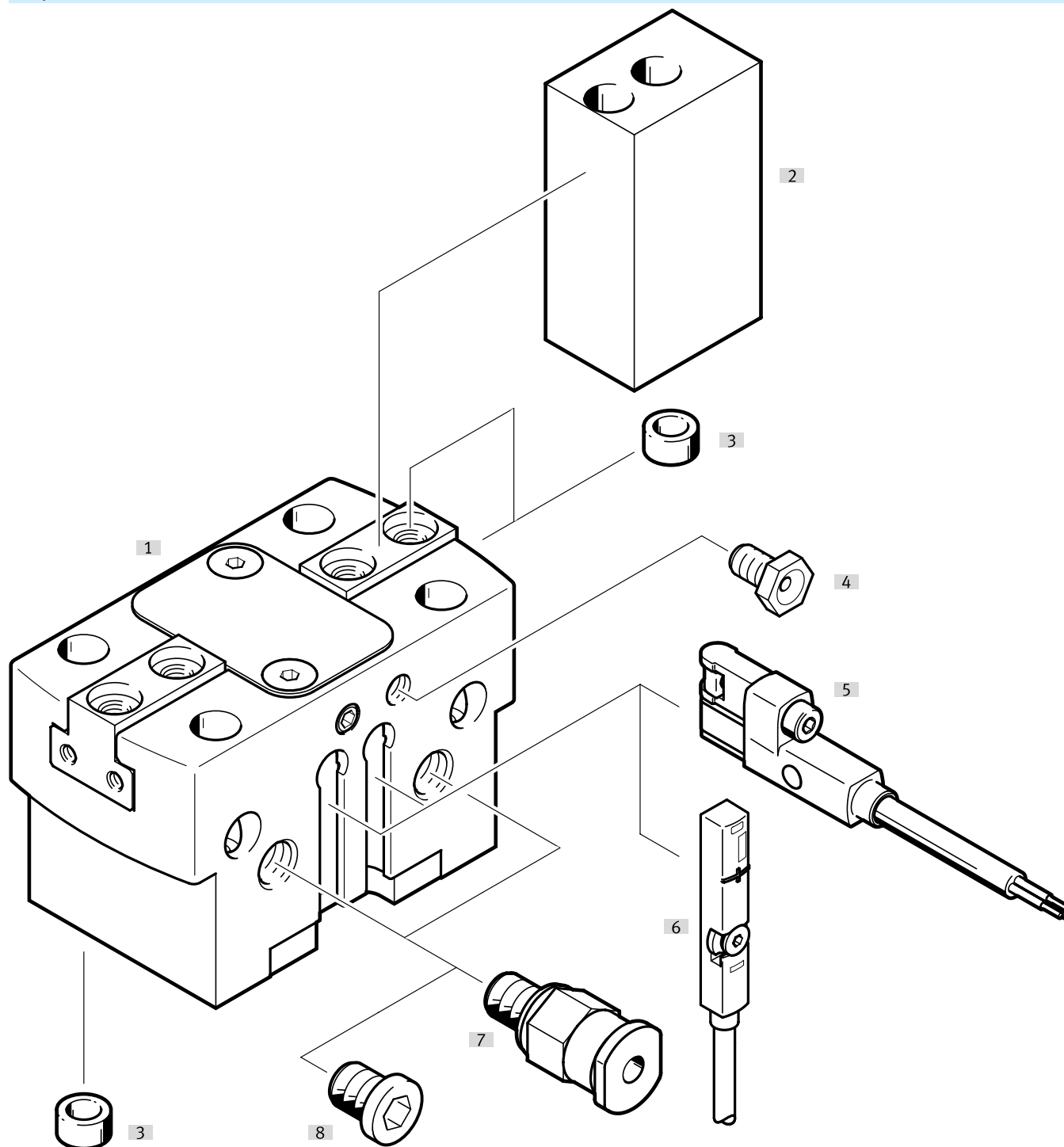



Accessories		→ Link
Type/order code	Description	
[1] Parallel gripper HGPT	Double-acting drive, heavy-duty	hgpt
[2] Gripper jaw blank BUB-HGPT	Blanks specially matched to the gripper jaws for custom manufacturing of gripper fingers	39
[3] Centring sleeve ZBH	<ul style="list-style-type: none"> • For centring the gripper jaw blanks/gripper fingers on the gripper jaws • For centring the gripper during mounting • Centring sleeves are included in the scope of delivery of the gripper 	39
[4] Lubrication nipple	Included in the scope of delivery of the gripper	hgpt
[5] Proximity switch SMT-8G/-10G	<ul style="list-style-type: none"> • For sensing the piston position • Proximity switch closes flush with the bottom of the housing 	41
[6] Position transmitter SMAT-8M/SDAT	Continuously detects the position of the piston. It has an analogue output with an output signal that is proportional to the piston position.	42

Peripherals

Accessories		→ Link
Type/order code	Description	
[7] Push-in fitting QS	For connecting tubing with standard O.D	qs
[8] Blanking plug B	For sealing the compressed air ports when using the bottom compressed air ports	40
[9] Adapter kit DHAA, HAPG	Drive/gripper connections	adapter

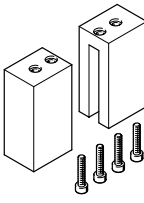
Accessories

Gripper jaw blank BUB-HGPT						
	Description	Material unmachined part	Product weight per gripper jaw	Part no.	Type	
	For size 16	Wrought aluminium alloy	29 g	560244	BUB-HGPT-16-B	
	For size 20		53 g	560245	BUB-HGPT-20-B	
	For size 25		98 g	560246	BUB-HGPT-25-B	
	For size 35		161 g	560247	BUB-HGPT-35-B	
	For size 40		280 g	560248	BUB-HGPT-40-B	
	For size 50		622 g	560249	BUB-HGPT-50-B	
	For size 63		1,213 g	560250	BUB-HGPT-63-B	
	For size 80		1,738 g	560251	BUB-HGPT-80-B	

Centring sleeve ZBH-5						
	Description	Material sleeve	Size of pack	Product weight	Part no.	Type
	For sizes 16, 20, 25	Steel	10	1 g	8146543	ZBH-5-B

Centring sleeve ZBH-7						
	Description	Material sleeve	Size of pack	Product weight	Part no.	Type
	For sizes 25, 35, 40, 50, 63	Steel	10	1 g	8146544	ZBH-7-B

Centring sleeve ZBH-9						
	Description	Material sleeve	Size of pack	Product weight	Part no.	Type
	For sizes 35, 40, 50, 80	Steel	10	2 g	8137184	ZBH-9-B

Centring sleeve ZBH-12						
	Description	Material sleeve	Size of pack	Product weight	Part no.	Type
	For sizes 50, 63, 80	Steel	10	1 g	8137185	ZBH-12-B

Centring sleeve ZBH-15						
	Description	Material sleeve	Size of pack	Product weight	Part no.	Type
	For size 80	High-alloy stainless steel	10	3 g	191409	ZBH-15

Connector sleeve ZBV-6						
	Description	Material sleeve	Size of pack	Product weight	Part no.	Type
	For sizes 16 ... 80	Steel	1	0.26 g	571033	ZBV-6-5

Connector sleeve ZBV-8						
	Description	Material sleeve	Size of pack	Product weight	Part no.	Type
	For sizes 16 ... 80	Steel	1	0.63 g	571034	ZBV-8-7

Accessories

Connector sleeve ZBV-9

	Description	Material sleeve	Size of pack	Product weight	Part no.	Type
	For sizes 16 ... 80	Steel	1	0.75 g	560253	ZBV-9-8

Connector sleeve ZBV-12

	Description	Material sleeve	Size of pack	Product weight	Part no.	Type
	For sizes 16 ... 80	Steel	1	2.3 g	571035	ZBV-12-10

Connector sleeve ZBV-14

	Description	Material sleeve	Size of pack	Product weight	Part no.	Type
	For sizes 16 ... 80	Steel	1	1.9 g	560255	ZBV-14-12

Blanking plug B-M3

	Description	Material blanking plug	Size of pack	Product weight	Part no.	Type
	For sizes 16, 20	High-alloy stainless steel	10	1 g	30979	B-M3-S9

Blanking plug B-M5

	Description	Material blanking plug	Size of pack	Product weight	Part no.	Type
	For sizes 25, 35, 40	Galvanised steel	10	1 g	174308	B-M5-B

Blanking plug B-1/8

	Description	Material blanking plug	Size of pack	Product weight	Part no.	Type
	For size 50, 63	Galvanised steel	10	7 g	3568	B-1/8

Blanking plug B-1/4

	Description	Material blanking plug	Size of pack	Product weight	Part no.	Type
	For size 80	Galvanised steel	10	15 g	3569	B-1/4

Proximity switch SMT-10G for round slot, magneto-resistive – For sizes 16 ... 35

[Link](#) 

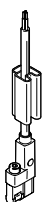
	Type of mounting	Switching output	Electrical connection	Cable length	Part no.	Type
	Clamped in C-slot, Insertable in the slot lengthwise	3-wire NPN N/O contact	Open end	2.5 m	8065030	SMT-10G-NS-24V-E-2,5Q-OE

Accessories

Proximity switch SMT-10G for round slot, magneto-resistive – For sizes 16 ... 35							Link smt
	Type of mounting	Switching output	Electrical connection	Cable length	Part no.	Type	
	Clamped in C-slot, Insertable in the slot lengthwise	3-wire NPN N/O contact	Plug M8, A-coded	0.3 m	8065029	SMT-10G-NS-24V-E-0,3Q-M8D	
		3-wire PNP N/O contact	Open end	2.5 m	547862	SMT-10G-PS-24V-E-2,5Q-OE	
			Plug M8, A-coded	0.3 m	547863	SMT-10G-PS-24V-E-0,3Q-M8D	

Proximity switch SMT-8G for T-slot, magneto-resistive – For sizes 40 ... 80							Link smt
	Type of mounting	Switching output	Electrical connection	Cable length	Part no.	Type	
	Clamped in T-slot, Insertable in the slot lengthwise	3-wire NPN N/O contact	Open end	2.5 m	8065028	SMT-8G-NS-24V-E-2,5Q-OE	
			Plug M8, A-coded	0.3 m	8065027	SMT-8G-NS-24V-E-0,3Q-M8D	
		3-wire PNP N/O contact	Open end	2.5 m	547859	SMT-8G-PS-24V-E-2,5Q-OE	
			Plug M8, A-coded	0.3 m	547860	SMT-8G-PS-24V-E-0,3Q-M8D	

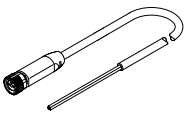
Connecting cables NEBA, straight						
	Electrical connection 1, connector system	Electrical connection 2, connector system	Electrical connection 2, number of connections/ cores	Cable length	Part no.	Type
	M8x1, A-coded, to EN 61076-2-104	Open end	3	2.5 m	8078223	NEBA-M8G3-U-2.5-N-LE3
				5 m	8078224	NEBA-M8G3-U-5-N-LE3

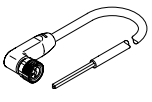
Connecting cables NEBA, angled						
	Electrical connection 1, connector system	Electrical connection 2, connector system	Electrical connection 2, number of connections/ cores	Cable length	Part no.	Type
	M8x1, A-coded, to EN 61076-2-104	Open end	3	2.5 m	8078230	NEBA-M8W3-U-2.5-N-LE3
				5 m	8078231	NEBA-M8W3-U-5-N-LE3

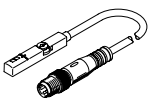
Position transmitter SMAT-8M for T-slot, M8 plug, A-coded – for size 40 ... 80							Link smt
	Sensing range ¹⁾	Analogue output	Electrical connection 1, number of connections/ cores	Cable length	Part no.	Type	
	52 mm	0 - 10 V	4	0.3 m	553744	SMAT-8M-U-E-0,3-M8D	

1) Measuring range: sizes 40 and 50 can be measured over the entire stroke. For sizes 63 and 80, a stroke of 13 mm (6.5 mm for the high force version) can be measured. Two position transmitters are required to measure longer strokes. Protrusion: in sizes 40 and 50, the position transmitter protrudes beyond the rear of the housing.

Accessories

Position transmitter SDAT for T-slot, M8 plug, A-coded – for size 63 ... 80

[Link](#) [sd](#)[at](#)

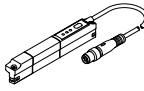
	Sensing range	Analogue output	Electrical connection 1, number of connections/ cores	Cable length	Part no.	Type
	0 ... 50.000 mm	4 - 20 mA	4	0.3 m	1531265	SDAT-MHS-M50-1L-SA-E-0.3-M8

Connecting cables NEBA, straight

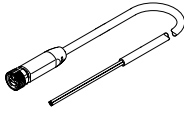
	Electrical connection 1, connector system	Electrical connection 2, connector system	Electrical connection 2, number of connections/ cores	Cable length	Part no.	Type
	M8x1, A-coded, to EN 61076-2-104	Open end	4	2.5 m	8078227	NEBA-M8G4-U-2.5-N-LE4
				5 m	8078228	NEBA-M8G4-U-5-N-LE4

Connecting cables NEBA, angled

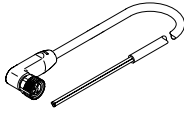
	Electrical connection 1, connector system	Electrical connection 2, connector system	Electrical connection 2, number of connections/ cores	Cable length	Part no.	Type
	M8x1, A-coded, to EN 61076-2-104	Open end	4	2.5 m	8078233	NEBA-M8W4-U-2.5-N-LE4
				5 m	8078234	NEBA-M8W4-U-5-N-LE4