

Datasheet

RS Pro 0.33in White Plain Nylon Flanged Hex Nut, 4BA

RS Stock No: **522-027**



Product Details

RS Pro 0.33 Inch flanged hex nut has nylon construction for added durability. This 4BA thread-sized nut in white colour, has plain finishing. It offers effective insulation and superior corrosion resistance. This nut is suitable for use in high voltage assemblies.

Features and Benefits

- To BS57
- Ideal for use where good insulation and corrosion resistance is required
- Suitable for use in high voltage assemblies
- Moulded from ivory coloured nylon 66



ENGLISH

Specifications:

Colour	White
Finish	Plain
Flange Diameter	0.33 in
Material	Nylon 66
Overall Height	0.175 in
Thread Size	4BA
Specification	BS 57
Width Across Flats	0.248 in

RS Stk No.	Part No
522-033	020 2051
522-027	020 2052
522-011	020 2053
528-198	020 2054

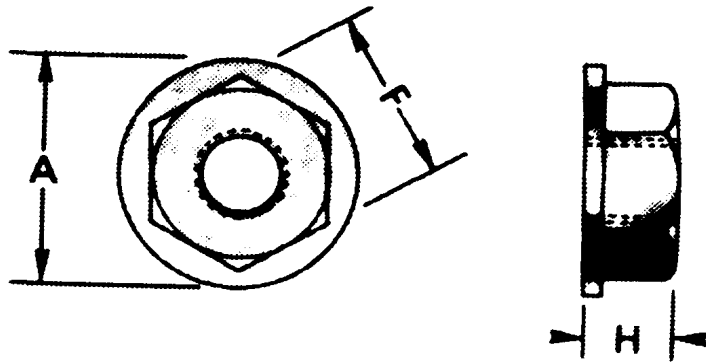

PART NUMBER	THREAD SIZE	A	F	H
020 2050	8BA	0.173	0.157	0.118
020 2051	6BA	0.275	0.193	0.141
020 2052	4BA	0.330	0.248	0.175
020 2053	2BA	0.391	0.324	0.217
020 2054	0BA	0.521	0.413	0.213

Material - **NYLON 66**

NOTE : All dimensions shown are maximum.