



SERIES 1065 - MICRO-SIGNAL SWITCHES

TO 100 mA 30 V DC



PRODUCT FEATURES

- Redundant contact system for high switching reliability by double contacting
- Self-cleaning contact system due to wiping contacting
- Center-zero version (basic type 1075) for detecting 3 switching positions
- Noiseless switching system
- Large overtravel

ON REQUEST

- Other fastening pins
- Other lever forms
- Customized cable assembly
- Diagnosis capable versions



































Mechanical life endurance	200E3
Contact resistance (new condition)	< 500 mOhm (1 A 12 V DC)
Insulation resistance (new condition)	> 100 MOhm (500 V DC)
Protection type	IP 00 terminal side basic types 1065 and 1075 IP 67 actuator side all basic types, terminal side basic type 1068
Ambient temperature	-40 °C ... +85 °C
Flammability	UL 94 HB
Material	actuator: POM / silicone rubber additional actuator: stainless steel spring steel housing: PBTP terminals: tinned
Contact material	AuCo
Shock resistance	50 g
Miscellaneous	terminal side sealed electrical life endurance at 14 V DC 10 mA ≥ 200E3, at 30V DC 100 mA ≥ 40E3

ROCKER SWITCHES
 PUSHBUTTON SWITCHES
 TOGGLE SWITCHES
 SLIDE SWITCHES
 ROTARY SWITCHES
 FOOT SWITCHES
 TACT AND KEY SWITCHES
 SMP-ACTION SWITCHES
 MICRO-SIGNAL SWITCHES
 SENSORS
 ECO
 PUSH IN DRIVE



SERIES 1065 - MICRO-SIGNAL SWITCHES

TO 100 mA 30 V DC

	≤ 25 V DC	100 mA 30 V DC 40E3	Terminal type	Terminal description	Operating force (N)	Switching point NCC (mm)	Minimum OFF range (mm)	Switching point NOC (mm)	Rest position (FP) max. (mm)	Permissible end position (TP) (mm)	Actuator description	Lever drawing	Miscellaneous	Stock version
Changeover switch (SPDT momentary) can be diagnosed														
1060.2601	○				≤ 1.6			8.95 ± 0.3	10.15	6.85			with resistor circuit pin right 2.5 long	
Normally open contact (SPNO)														
1068.0541	○		300 long 300 long		≤ 1.6			8.95 ± 0.3	10.15	6.85			pin right 5 long	
Changeover switch (SPDT momentary)														
1065.0503	○				≤ 1.6	9.45 ± 0.3		8.95 ± 0.3	10.15	6.85			pin both sides 5 long	
1065.0603	○				≤ 1.6	9.45 ± 0.3		8.95 ± 0.3	10.15	6.85			pin both sides 2.5 long	
1065.2000	○		coded cranked		≤ 1.6	13.8 ± 0.3		13.3 ± 0.3	14.5	11.2			without pin	
1065.3603	○				≤ 1.6	9.45 ± 0.3		8.95 ± 0.3	10.15	6.85			pin both sides 2.5 long	
1065.3653	○				≤ 1.6	9.45 ± 0.3		8.95 ± 0.3	10.15	6.85			pin both sides 2.5 long	
1065.5000	○				≤ 2.2	9.65 ± 0.45		9.15 ± 0.45	11.35	7.35		L02	pin both sides 5 long	
1065.5103	○				≤ 2.2	12.75 ± 0.65		12.05 ± 0.65	14.7	9		L21	pin both sides 2.5 long	
1065.5203	○				≤ 2.8	9.65 ± 0.45		9.15 ± 0.45	11.35	7.35		L31	pin right 5 long	
1065.7100	○		coded cranked		≤ 2.2	17.1 ± 0.65		16.4 ± 0.65	19.05	13.35		L21	without pin	
1068.0503	○		300 long 300 long		≤ 1.6	9.45 ± 0.3		8.95 ± 0.3	10.15	6.85			pin both sides 5 long	
1068.0601	○		300 long		≤ 1.6	9.45 ± 0.3		8.95 ± 0.3	10.15	6.85			pin right 2.5 long	
Changeover switch with OFF position in the center (SPDT momentary - Center OFF)														
1075.0603	○				≤ 1.6	9.45 ± 0.3	8.3 - 9.15	8 ± 0.3	10.15	6.85			pin both sides 2.5 long	
1075.2000	○		coded cranked		≤ 1.6	13.8 ± 0.3	12.65 - 13.5	12.35 ± 0.3	14.5	11.2			without pin	
1075.3603	○				≤ 1.6	9.45 ± 0.3	8.3 - 9.15	8 ± 0.3	10.15	6.85			pin right 2.5 long	
1075.3653	○				≤ 1.6	9.45 ± 0.3	8.3 - 9.15	8 ± 0.3	10.15	6.85			pin left 2.5 long	

ROCKER SWITCHES

PUSHBUTTON SWITCHES

TOGGLE SWITCHES

SLIDE SWITCHES

ROTARY SWITCHES

FOOT SWITCHES

TACT AND KEY SWITCHES

SNAP-ACTION SWITCHES

MICRO-SIGNAL SWITCHES

SENSORS

ECO

PUSH/DRIVE



SERIES 1065 - MICRO-SIGNAL SWITCHES

TO 100 mA 30 V DC



Basic type 1065

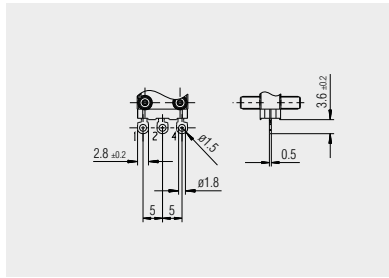

Solder terminal

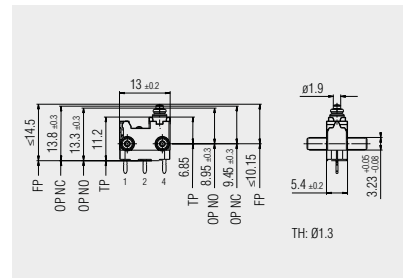

PCB terminal

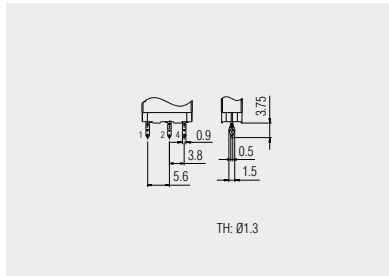

PCB terminal coded and cranked

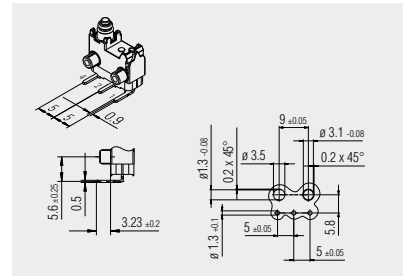

PCB terminal left angled

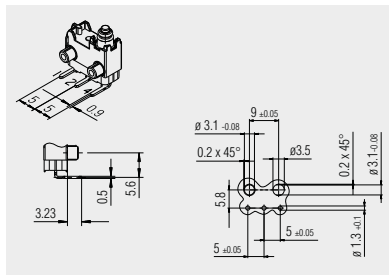

PCB terminal right angled



Basic type 1068

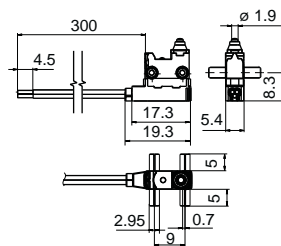

Cable 300 long, tinned wire ends

ROCKER SWITCHES
PUSHBUTTON SWITCHES
TOGGLE SWITCHES
SLIDE SWITCHES
ROTARY SWITCHES
FOOT SWITCHES
TACT AND KEY SWITCHES
SNAP-ACTION SWITCHES
MICRO-SIGNAL SWITCHES
SENSORS
ECO
PUSH IN DRIVE



SERIES 1065 - MICRO-SIGNAL SWITCHES

TO 100 mA 30 V DC

ROCKER SWITCHES

PUSHBUTTON SWITCHES

TOGGLE SWITCHES

SLIDE SWITCHES

ROTARY SWITCHES

FOOT SWITCHES

TACT AND KEY SWITCHES

SNAP-ACTION SWITCHES

MICRO-SIGNAL SWITCHES

SENSORS

ECO

PUSH/DRIVE



Basic type 1060/1070

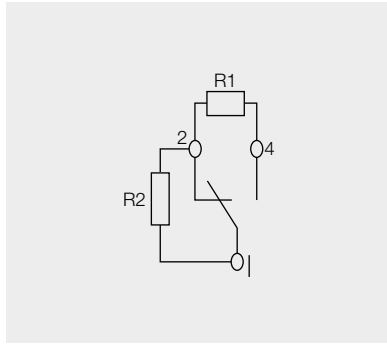

Switch diagnostics capability

Integrated resistors feature a circuit monitoring (short circuit, cable break, bad plug contacts)



Basic type 1075

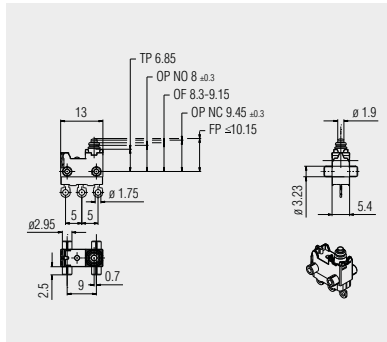

Due to the OFF range between the normally closed contact and the normally open contact increased in relation to basic type 1065 the switch can be used for determining three switching positions. As a result two conventional switches can be replaced by one of these new switch versions in many applications.



Auxiliary actuators

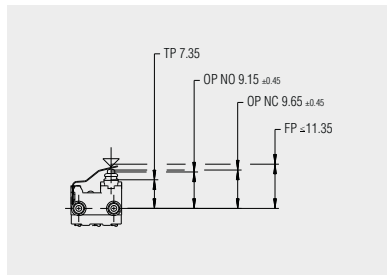

L01: straight lever

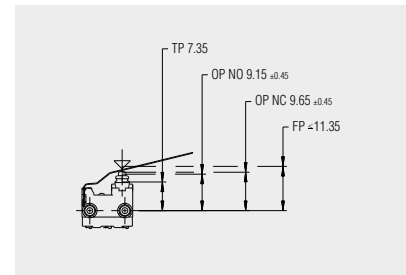

L02: straight lever

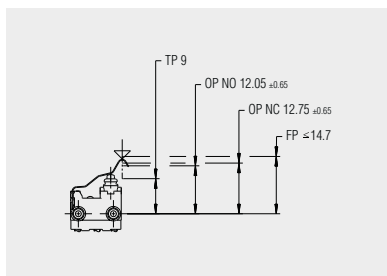

L21: simulated roller lever

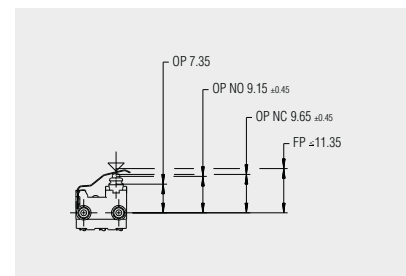

L31: differential levers



SERIES 1065 - MICRO-SIGNAL SWITCHES

TO 100 mA 30 V DC



Additional parts

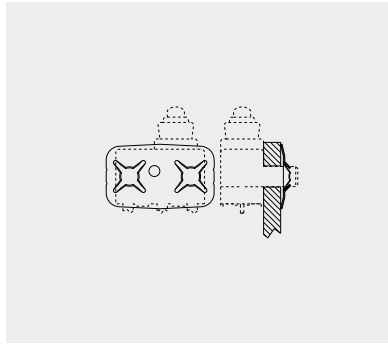

140.092.021

Fastening disc for the basic types 1065, 1068 and 1075

The fastening disc offers a fast, reliable fastening possibility in combination with switches with 5 mm long pins on plates or plastic parts with a wall thickness of up to 2.5 mm.

ROCKER SWITCHES

PUSHBUTTON SWITCHES

TOGGLE SWITCHES

SLIDE SWITCHES

ROTARY SWITCHES

FOOT SWITCHES

TACT AND KEY SWITCHES

SNAP-ACTION SWITCHES

MICRO-SIGNAL SWITCHES

SENSORS

ECO

PUSH-IN DRIVE

MARQUARDT INTERNATIONAL.

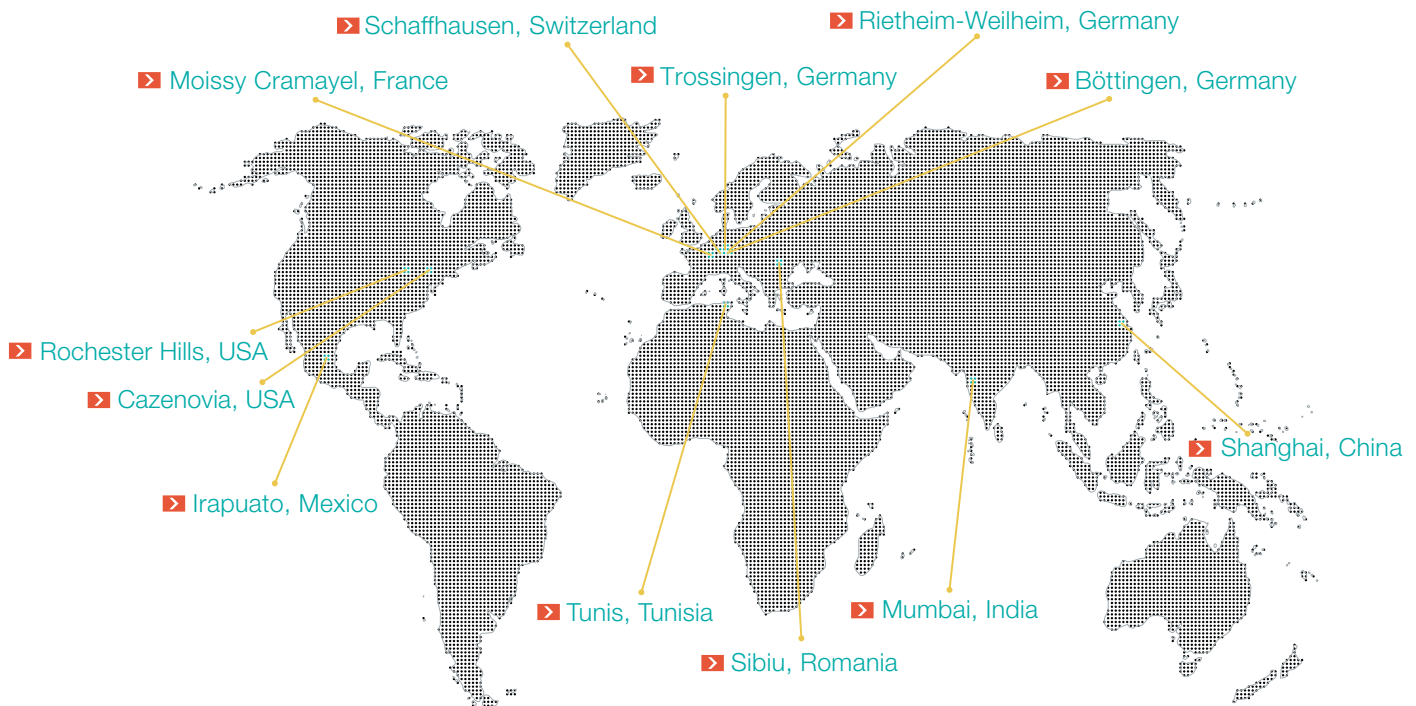

HEADQUARTERS

Marquardt Mechatronik GmbH

Schloss-Straße 16
78604 Rietheim-Weilheim / GERMANY
Tel. +49 (0)74 24/99-0
Fax +31 (0)74 24/99-2399
marquardt@marquardt.com
www.marquardt.com

Geuken



DISTRIBUTOR

GEUKEN B.V.

Wattstraat 25a
2723 RA Zoetermeer / NETHERLANDS
Tel. +31 (0)79 361 60 70
Fax +31 (0)79 361 40 90
info@geuken.nl
www.geuken.nl