

Mod. G7450 - Fittings Series 7000 - Automation

Product code: G7450 10-1/4

Datasheet creation date: 12/12/2025 08:30

Check the most updated document online [click here](#)



TECHNICAL DATA

Mod.	G7450 10-1/4
------	--------------

Mod. G7450 - Fittings Series 7000 - Automation

Product code: G7450 10-1/4

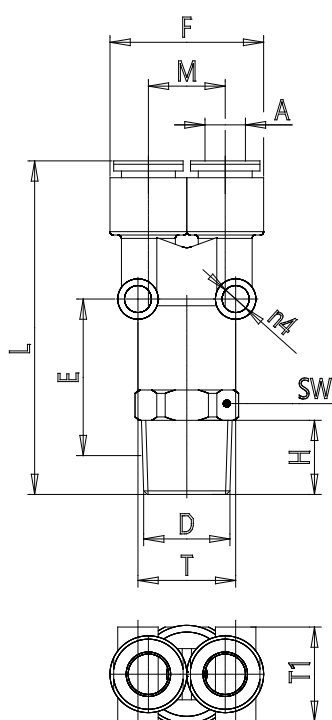

DIMENSIONS

A (mm)	10
D	R1/4
E (mm)	22.5
F (mm)	33.0
H (mm)	11.0
L (mm)	61.5
M (mm)	16.3
S (mm)	4
T (mm)	16.3
T1 (mm)	16.0
SW (mm)	17
Weight (g)	41