

## Mod. G7580 - Fittings Series 7000 - Automation

Product code: G7580 4-8

Datasheet creation date: 11/12/2025 09:26

Check the most updated document online [click here](#)



### TECHNICAL DATA

Mod.	G7580 4-8
------	-----------

## Mod. G7580 - Fittings Series 7000 - Automation

Product code: G7580 4-8

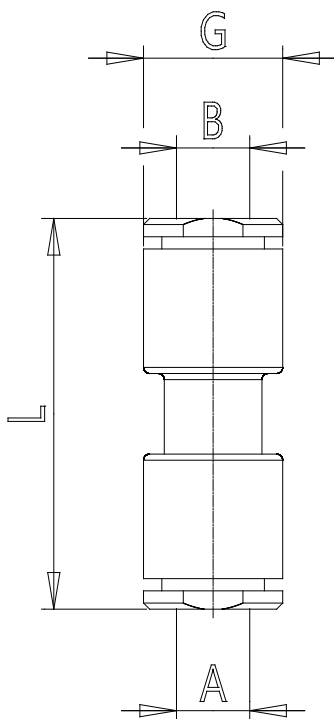

### **DIMENSIONS**

<b>A (mm)</b>	4
<b>B (mm)</b>	8
<b>GD (mm)</b>	13.7
<b>L (mm)</b>	34.5
<b>Weight (g)</b>	4.5