

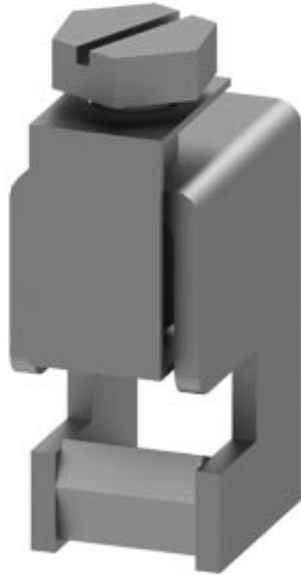





Busbar system, accessories Busbar center-to-center spacing 40, 60 mm Connection terminal Bar thickness: 10 mm+TT profile 16-120 mm²



Model	
product brand name	SENTRON
product designation	Connecting terminal
design of the product	Accessories
operating current / at AC / rated value	440 A
Connections	
type of connectable conductor cross-sections / for copper conductor / stranded	16-120 mm ²
Mechanical Design	
net weight	107 g
Certificates	

General Product Approval			Declaration of Conformity	Test Certificates	
 CSA	 UR		 EG-Konf.	Special Test Certificate	Miscellaneous

Shipping Approval	other
 PRS	 RINA
	Miscellaneous

Further information

Information- and Downloadcenter (Catalogs, Brochures,...)

<http://www.siemens.com/lowvoltage/catalogs>

Industry Mall (Online ordering system)

<https://mall.industry.siemens.com/mall/en/en/Catalog/product?mlfb=8US1921-2BC00>

Service&Support (Manuals, Certificates, Characteristics, FAQs,...)

<https://support.industry.siemens.com/cs/ww/en/ps/8US1921-2BC00>

Image database (product images, 2D dimension drawings, 3D models, device circuit diagrams, ...)

http://www.automation.siemens.com/bilddb/cax_en.aspx?mlfb=8US1921-2BC00

CAX-Online-Generator

<http://www.siemens.com/cax>

Tender specifications

<http://www.siemens.com/specifications>

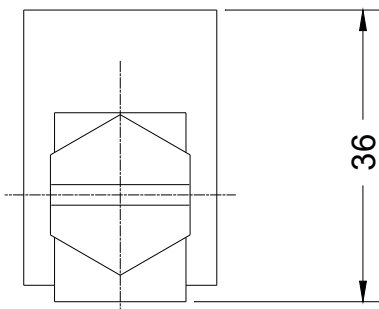
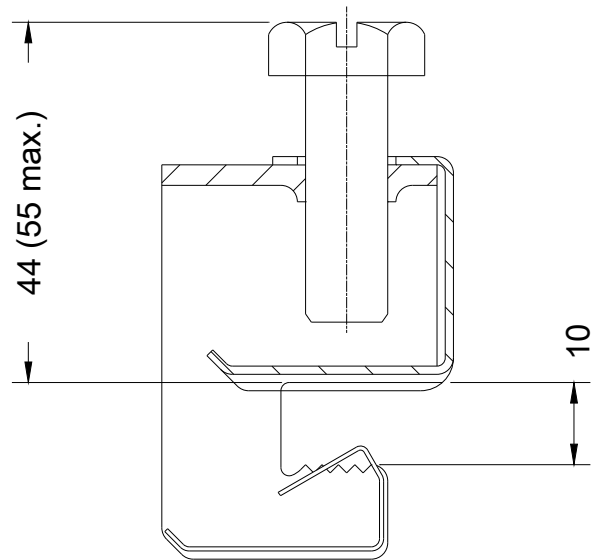
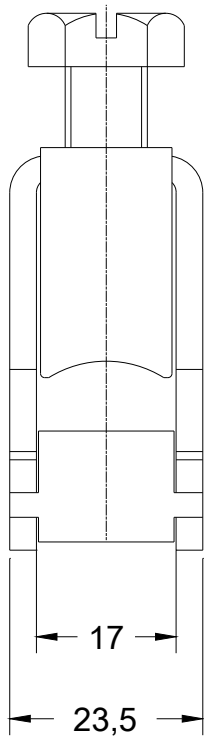

01 203