

# Reference Only

## Chip Ferrite Bead BLM18□□□□□□H1D

### Murata Standard Reference Specification[AEC-Q200]

#### 1.Scope

This reference specification applies to Chip Ferrite Bead for Automotive Electronics BLM18\_□H Series based on AEC-Q200.

#### 2.Part Numbering

(ex.) BL M 18 AG 121 S H 1 D  
 (1) Product ID (2) Type (3) Dimension (LxW) (4) Characteristics (5) Typical Impedance at 100MHz (6) Performance (7) Category(for Automotive Electronics) (8) Numbers of Circuit (9) Packaging (D:Taping)

#### 3.Rating

Customer Part Number	MURATA Part Number	Impedance (Ω) (at 100MHz)(*1) (refer to below comment)		Rated Current (mA)		DC Resistance (Ω max.) (*1) (refer to below comment)		ESD Rank 2:2kV 6:25kV
		Typical	at 85°C	at 125°C	Initial Values	Values After Testing		
	BLM18PG300SH1D	20 min.	30	1000		0.05	0.10	6
	BLM18PG330SH1D	33±25%	33	3000*2	1000*2	0.025	0.050	
	BLM18PG600SH1D	40 min.	60	500		0.1	0.2	
	BLM18PG121SH1D	120±25%	120	2000*2	1000*2	0.05	0.10	
	BLM18PG181SH1D	180±25%	180	1500*2	1000*2	0.09	0.18	
	BLM18PG221SH1D	220±25%	220	1400*2	1000*2	0.10	0.14	
	BLM18PG331SH1D	330±25%	330	1200*2	1000*2	0.15	0.20	
	BLM18PG471SH1D	470±25%	470	1000		0.20	0.26	2
	BLM18SN220TH1D	22±7	22	8000*2	5000*2	0.004	0.005	
	BLM18KG260TH1D	26±25%	26	6000*2	2000*2	0.007	0.012	
	BLM18KG300TH1D	30±25%	30	5000*2	2000*2	0.010	0.015	
	BLM18KG700TH1D	70±25%	70	3500*2	1000*2	0.022	0.032	
	BLM18KG101TH1D	100±25%	100	3000*2	1000*2	0.030	0.040	
	BLM18KG121TH1D	120±25%	120	3000*2	1000*2	0.030	0.040	
	BLM18KG221SH1D	220±25%	220	2200*2	1000*2	0.050	0.060	
	BLM18KG331SH1D	330±25%	330	1700*2	1000*2	0.080	0.095	
	BLM18KG471SH1D	470±25%	470	1500*2	1000*2	0.130	0.145	
	BLM18KG601SH1D	600±25%	600	1300*2	1000*2	0.150	0.165	2
	BLM18AG121SH1D	120±25%	120	800		0.18	0.28	
	BLM18AG151SH1D	150±25%	150	700		0.25	0.35	
	BLM18AG221SH1D	220±25%	220	700		0.25	0.35	
	BLM18AG331SH1D	330±25%	330	600		0.30	0.40	
	BLM18AG471SH1D	470±25%	470	550		0.35	0.45	
	BLM18AG601SH1D	600±25%	600	500		0.38	0.48	
	BLM18AG102SH1D	1000±25%	1000	450		0.50	0.60	2
	BLM18BB050SH1D	5±25%	5	700		0.05	0.10	
	BLM18BA050SH1D	5±25%	5	500		0.2	0.3	
	BLM18BB100SH1D	10±25%	10	700		0.10	0.20	
	BLM18BA100SH1D	10±25%	10	500		0.25	0.35	
	BLM18BB220SH1D	22±25%	22	600		0.20	0.30	
	BLM18BA220SH1D	22±25%	22	500		0.35	0.45	
	BLM18BB470SH1D	47±25%	47	550		0.25	0.35	
	BLM18BD470SH1D	47±25%	47	500		0.3	0.4	
	BLM18BA470SH1D	47±25%	47	300		0.55	0.65	

# Reference Only

Customer Part Number	MURATA Part Number	Impedance (Ω) (at 100MHz)(*1) (refer to below comment)	Rated Current (mA) (*2)		DC Resistance (Ω max.) (*1) (refer to below comment)		ESD Rank 2:2kV 6:25kV
			Typical	at 85°C   at 125°C	Initial Values	Values After Testing	
	BLM18BB600SH1D	60±25%	60	550	0.25	0.35	2
	BLM18BA750SH1D	75±25%	75	300	0.70	0.80	
	BLM18BB750SH1D	75±25%	75	500	0.30	0.40	
	BLM18BB121SH1D	120±25%	120	500	0.30	0.40	
	BLM18BD121SH1D	120±25%	120	300	0.4	0.5	
	BLM18BA121SH1D	120±25%	120	200	0.9	1.0	
	BLM18BB141SH1D	140±25%	140	450	0.35	0.45	
	BLM18BB151SH1D	150±25%	150	450	0.37	0.47	
	BLM18BD151SH1D	150±25%	150	300	0.4	0.5	
	BLM18BB221SH1D	220±25%	220	450	0.45	0.55	
	BLM18BD221SH1D	220±25%	220	250	0.45	0.55	
	BLM18BB331SH1D	330±25%	330	400	0.58	0.68	
	BLM18BD331SH1D	330±25%	330	250	0.5	0.6	
	BLM18BD421SH1D	420±25%	420	250	0.55	0.65	
	BLM18BB471SH1D	470±25%	470	300	0.85	0.95	
	BLM18BD471SH1D	470±25%	470	250	0.55	0.65	
	BLM18BD601SH1D	600±25%	600	200	0.65	0.75	
	BLM18BD102SH1D	1000±25%	1000	200	0.85	0.95	
	BLM18BD152SH1D	1500±25%	1500	150	1.2	1.3	
	BLM18BD182SH1D	1800±25%	1800	150	1.5	1.6	
	BLM18BD222SH1D	2200±25%	2200	150	1.5	1.6	
	BLM18BD252SH1D	2500±25%	2500	150	1.5	1.6	

• Operating Temperature : -55°C to +125°C

• Storage Temperature : -55°C to +125°C

(\*1)

**Standard Testing Conditions**

< Unless otherwise specified >

Temperature : Ordinary Temp. (15 °C to 35 °C )

Humidity : Ordinary Humidity (25%(RH) to 85%(RH))

< In case of doubt >

Temperature : 20°C±2 °C

Humidity : 60%(RH) to 70%(RH)

Atmospheric pressure : 86kPa to 106kPa

(\*2) In case of Rated current is more than 1A,

Rated Current is derated as right figure depending on the operating temperature.

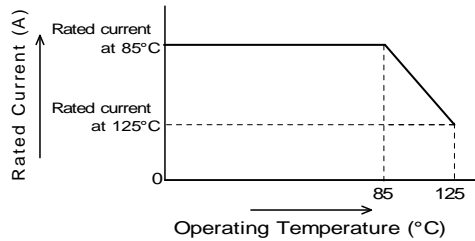

**4.Style and Dimensions**

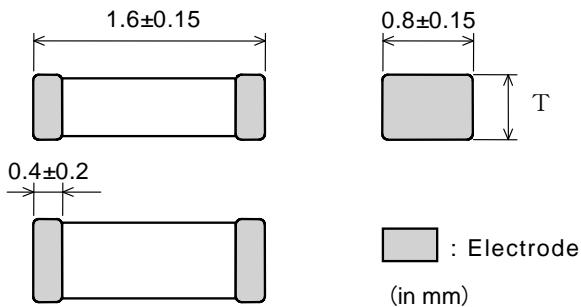

P/N	T
BLM18_SH	0.8±0.15
BLM18_TH	0.6±0.15

■ Equivalent Circuit

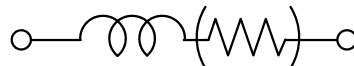

( Resistance element becomes dominant at high frequencies. )

■ Unit Mass (Typical value)

BLM18\_SH : 0.005g

BLM18\_TH : 0.004g

# Reference Only

Spec. No. JENF243A-9101K-01

P.3/10

## 5. Marking

No marking.

## 6. Specifications

### 6-1. Electrical Performance

No.	Item	Specification	Test Method
6-1-1	Impedance	Meet item 3.	Measuring Frequency : 100MHz±1MHz Measuring Equipment : Agilent 4291A or the equivalent Test Fixture : Agilent 16192A or the equivalent
6-1-2	DC Resistance	Meet item 3.	Measuring Equipment : Digital multi meter  For BLM18SN Measuring Equipment : YOKOGAWA 755611 or the equivalent Test Fixture : Agilent 16044A or the equivalent *Except resistance of the Substrate and Wire

### 6-2. Mechanical Performance(based on Table 13 for FILTER EMI SUPPRESSORS/FILTERS)

AEC-Q200 Rev.D issued June. 1 2010

AEC-Q200			Murata Specification / Deviation						
No.	Stress	Test Method							
3	High Temperature Exposure	1000hours at 125 deg C Set for 24hours at room temperature, then measured.	Meet Table A after testing. <u>Table A</u> <table border="1" style="margin-left: 20px;"> <tr> <td>Appearance</td> <td>No damage</td> </tr> <tr> <td>Impedance Change (at 100MHz)</td> <td>Within ±30% (for BLM18KG/SN Within ±50%)</td> </tr> <tr> <td>DC Resistance</td> <td>Meet item 3.</td> </tr> </table>	Appearance	No damage	Impedance Change (at 100MHz)	Within ±30% (for BLM18KG/SN Within ±50%)	DC Resistance	Meet item 3.
Appearance	No damage								
Impedance Change (at 100MHz)	Within ±30% (for BLM18KG/SN Within ±50%)								
DC Resistance	Meet item 3.								
4	Temperature Cycling	1000cycles -55 deg C to +125 deg C Set for 24hours at room temperature, then measured.	Meet Table B after testing. <u>Table B</u> <table border="1" style="margin-left: 20px;"> <tr> <td>Appearance</td> <td>No damage</td> </tr> <tr> <td>Impedance Change (at 100MHz)</td> <td>Within ±30% (for BLM18SN Within ±50%) (for BLM18KG Within-10%to+50%)</td> </tr> <tr> <td>DC Resistance</td> <td>Meet item 3.</td> </tr> </table>	Appearance	No damage	Impedance Change (at 100MHz)	Within ±30% (for BLM18SN Within ±50%) (for BLM18KG Within-10%to+50%)	DC Resistance	Meet item 3.
Appearance	No damage								
Impedance Change (at 100MHz)	Within ±30% (for BLM18SN Within ±50%) (for BLM18KG Within-10%to+50%)								
DC Resistance	Meet item 3.								
5	Destructive Physical Analysis	Per EIA469 No electrical tests	No defects						
7	Biased Humidity	1000hours at 85 deg C, 85%RH Apply max rated current.	Meet Table A after testing.						
8	Operational Life	Apply 125 deg C 1000hours Set for 24hours at room temperature, then measured	Meet Table A after testing. If the rated current of parts exceed 1A, the operating temperature should be 85 deg C.						
9	External Visual	Visual inspection	No abnormalities						
10	Physical Dimension	Meet ITEM 4 (Style and Dimensions)	No defects						
12	Resistance to Solvents	Per MIL-STD-202 Method 215	Not Applicable						

AEC-Q200			Murata Specification / Deviation						
No.	Stress	Test Method							
13	Mechanical Shock	Per MIL-STD-202 Method 213 Condition F 1500g's (14.7N)/0.5ms/ Half sine	Meet Table C after testing. Table C <table border="1" style="margin-left: 20px;"> <tr> <td>Appearance</td> <td>No damage</td> </tr> <tr> <td>Impedance Change (at 100MHz)</td> <td>Within ±30%</td> </tr> <tr> <td>DC Resistance</td> <td>Meet item 3.</td> </tr> </table>	Appearance	No damage	Impedance Change (at 100MHz)	Within ±30%	DC Resistance	Meet item 3.
Appearance	No damage								
Impedance Change (at 100MHz)	Within ±30%								
DC Resistance	Meet item 3.								
14	Vibration	5g's(0.049N) for 20 minutes, 12cycles each of 3 orientations Test from 10-2000Hz.	Meet Table C after testing.						
15	Resistance to Soldering Heat	Solder temperature 260C+/-5 deg C Immersion time 10s	Pre-heating:150C +/-10 deg,60s to 90s Meet Table A after testing.						
17	ESD	Per AEC-Q200-002	Meet Table C after testing. ESD Rank: Meet Item 3. (Rating)						
18	Solderability	Per J-STD-002	Method b : Not Applicable 95% of the terminations is to be soldered.						
19	Electrical Characterization	Measured : Impedance	No defects						
20	Flammability	Per UL-94	Not Applicable						
21	Board Flex	Epoxy-PCB(1.6mm) Deflection 2mm(min) 60s minimum holding tim	Meet Table A after testing.						
22	Terminal Strength	Per AEC-Q200-006	No defects						
30	Electrical Transient Conduction	Per ISO-7637-2	Not Applicable						

**7.Specification of Packaging**

**7-1.Appearance and Dimensions (8mm-wide paper tape)**

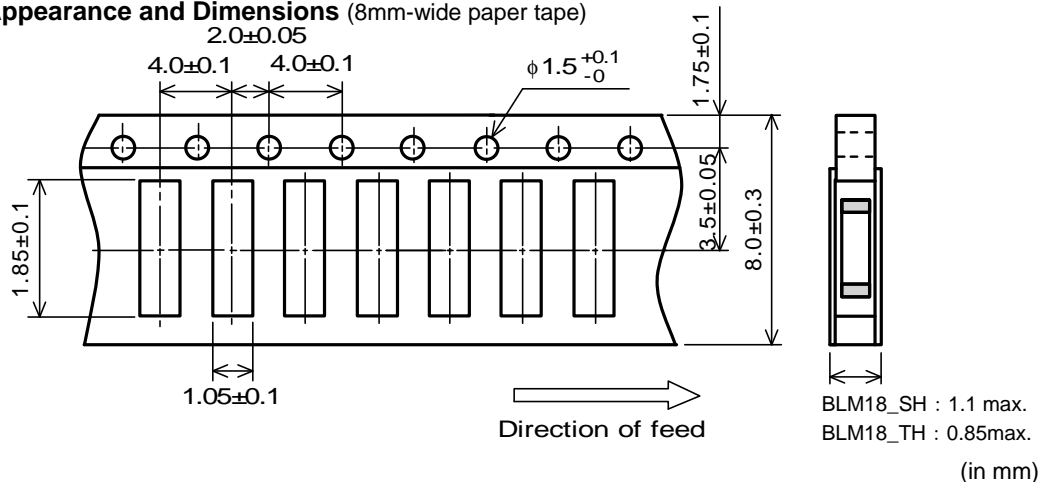



### 7-4. Specification of Outer Case

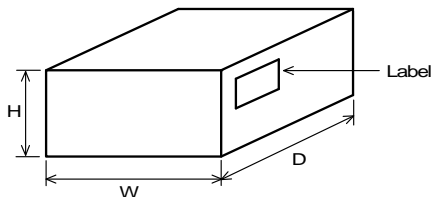

Outer Case Dimensions (mm)			Standard Reel Quantity in Outer Case (Reel)
W	D	H	
186	186	93	5

\* Above Outer Case size is typical. It depends on a quantity of an order.

## 8. Caution

### 8-1. Rating

Do not use products beyond the Operating Temperature Range and Rated Current.

### 8-2. Surge current

Excessive surge current (pulse current or rush current) than specified rated current applied to the product may cause a critical failure, such as an open circuit, burnout caused by excessive temperature rise. Please contact us in advance in case of applying the surge current.

### 8-3. Fail Safe

Be sure to provide an appropriate fail-safe function on your product to prevent from a second damage that may be caused by the abnormal function or the failure of our products.

### 8-4. Limitation of Applications

Please contact us before using our products for the applications listed below which require especially high reliability for the prevention of defects which might directly cause damage to the third party's life, body or property.

- |                                   |   |
|-----------------------------------|---|
| (1) Aircraft equipment            | (6) Disaster prevention / crime prevention equipment  |
| (2) Aerospace equipment           | (7) Traffic signal equipment  |
| (3) Undersea equipment            | (8) Transportation equipment (trains, ships, etc.)  |
| (4) Power plant control equipment | (9) Applications of similar complexity and /or reliability requirements to the applications listed in the above |
| (5) Medical equipment             |   |

## 9. Notice

This product is designed for solder mounting.

Please consult us in advance for applying other mounting method such as conductive adhesive.

### 9-1. Land pattern designing

- Standard land dimensions

< For BLM18 series (except BLM18PG/KG/SN type) >

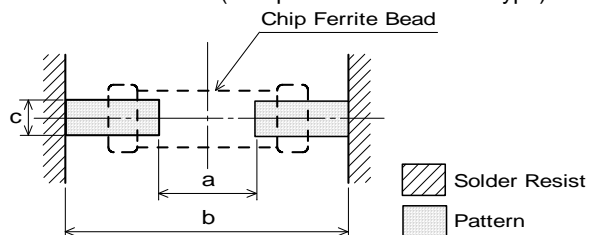

Type	Soldering	a	b	c
BLM18 (except 18PG/KG/SN type)	Flow	0.7	2.2 to 2.6	0.7
	Reflow		1.8 to 2.0	

(in mm)

< For BLM18PG/KG/SN type >

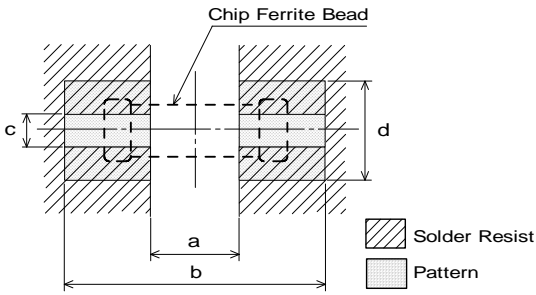

Type	Rated Current (A)	a	b	c	Land pad thickness and dimension d		
					18μm	35μm	70μm
BLM18PG	0.5 to 1.5	0.7	Flow 2.2 to 2.6	0.7	0.7	0.7	0.7
	1.7 to 2.5				1.2	0.7	0.7
BLM18KG	3 to 4				2.4	1.2	0.7
	5 to 6		6.4	3.3	1.65		
BLM18SN	8	0.7	2.0	0.7	-	6.4	3.3

(in mm)

\*The excessive heat by land pads may cause deterioration at joint of products with substrate.

### 9-2. Soldering Conditions

Products can be applied to reflow and flow soldering.

#### (1) Flux, Solder

Flux	Use rosin-based flux, but not highly acidic flux (with chlorine content exceeding 0.2(wt)%.) Do not use water-soluble flux.
Solder	Use Sn-3.0Ag-0.5Cu solder Standard thickness of solder paste : 100 μm to 200 μm

#### (2) Soldering conditions

- Pre-heating should be in such a way that the temperature difference between solder and ferrite surface is limited to 150°C max. Also cooling into solvent after soldering should be in such a way that the temperature difference is limited to 100°C max.

Insufficient pre-heating may cause cracks on the ferrite, resulting in the deterioration of product quality.

- Standard soldering profile and the limit soldering profile is as follows.

The excessive limit soldering conditions may cause leaching of the electrode and / or resulting in the deterioration of product quality.

#### (3) soldering profile

Flow soldering profile

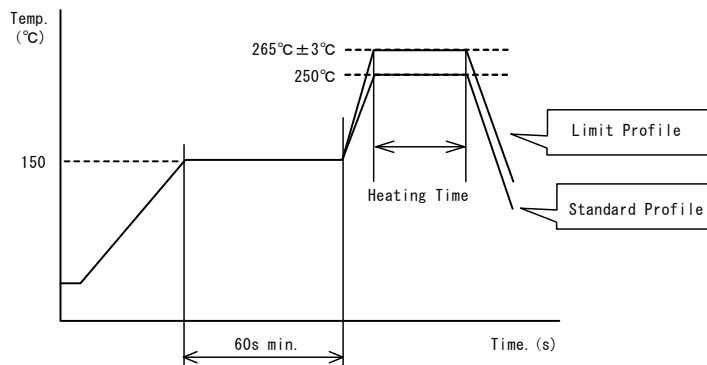

	Standard Profile	Limit Profile
Pre-heating	150°C、60s min.	
Heating	250°C、4~6s	265°C ± 3°C、5s max.
Cycle of flow	2 times	2 times

Reflow soldering profile

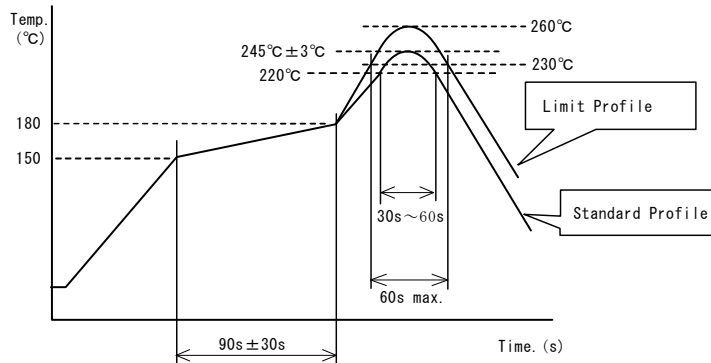

	Standard Profile	Limit Profile
Pre-heating	150~180°C、90s±30s	
Heating	above 220°C、30s~60s	above 230°C、60s max.
Peak temperature	245±3°C	260°C,10s
Cycle of reflow	2 times	2 times

**9-3.Reworking with soldering iron**

- Pre-heating: 150°C, 1 min
- Tip temperature: 350°C max.
- Soldering time : 3(+1,-0) seconds.
- Soldering iron output: 80W max.
- Tip diameter: φ 3mm max.
- Times : 2times max.

Note :Do not directly touch the products with the tip of the soldering iron in order to prevent the crack on the ferrite material due to the thermal shock.

**9-4.Solder Volume**

Solder shall be used not to be exceeded as shown below.

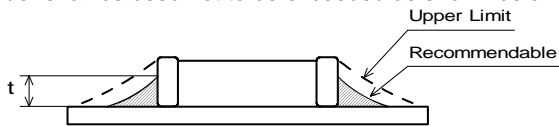

Accordingly increasing the solder volume, the mechanical stress to product is also increased. Exceeding solder volume may cause the failure of mechanical or electrical performance.

**9-5.Attention regarding P.C.B. bending**

The following shall be considered when designing and laying out P.C.B.'s.

(1) P.C.B. shall be designed so that products are not subject to the mechanical stress for board warpage.

<Products direction>

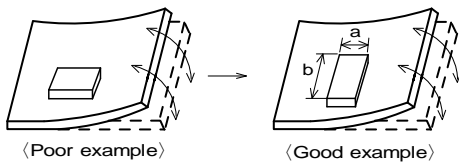

Products shall be located in the sideways direction (Length:a<b) to the mechanical stress.

(2)Products location on P.C.B. separation.

Products (A,B,C,D) shall be located carefully so that products are not subject to the mechanical stress due to warping the board. Because they may be subjected the mechanical stress in order of A>C>B ≡ D.

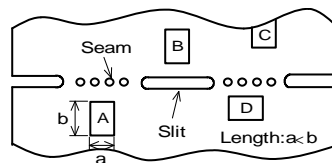



**9-6. Mounting density**

Add special attention to radiating heat of products when mounting the inductor near the products with heating. The excessive heat by other products may cause deterioration at joint of this product with substrate.

**9-7. Operating Environment**

Do not use this product under the following environmental conditions, on deterioration of the Insulation Resistance of the Ferrite material and/or corrosion of Inner Electrode may result from the use.

- (1) in the corrodible atmosphere (acidic gas, alkaline gas, chlorine, sulfur gas, organic gas and etc.)
- (2) in the atmosphere where liquid such as organic solvent, may splash on the products.
- (3) in the atmosphere where the temperature / humidity changes rapidly and it is easy to dew.

**9-8. Resin coating**

The impedance value may change and/or it may affect on the product's performance due to high cure-stress of resin to be used for coating / molding products. So please pay your careful attention when you select resin. In prior to use, please make the reliability evaluation with the product mounted in your application set.

**9-9. Cleaning Conditions**

Products shall be cleaned on the following conditions.

- (1) Cleaning temperature shall be limited to 60°C max. (40°C max. for IPA.)
- (2) Ultrasonic cleaning shall comply with the following conditions, avoiding the resonance phenomenon at the mounted products and P.C.B.  
Power: 20W/ℓ max. Frequency: 28kHz to 40kHz Time: 5 min max.
- (3) Cleaner
  1. Alternative cleaner
    - Isopropyl alcohol (IPA)
  2. Aqueous agent
    - PINE ALPHA ST-100S
- (4) There shall be no residual flux and residual cleaner after cleaning.  
In the case of using aqueous agent, products shall be dried completely after rinse with de-ionized water in order to remove the cleaner.
- (5) Other cleaning  
Please contact us.

**9-10. Handling of a substrate**

After mounting products on a substrate, do not apply any stress to the product caused by bending or twisting to the substrate when cropping the substrate, inserting and removing a connector from the substrate or tightening screw to the substrate.

Excessive mechanical stress may cause cracking in the product.

Bending

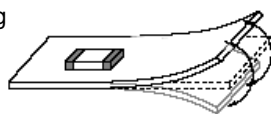

Twisting

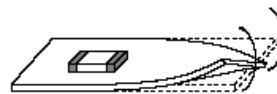
**9-11. Storage Conditions**

- (1) Storage period  
Use the products within 6 months after delivered.  
Solderability should be checked if this period is exceeded.
- (2) Storage conditions
  - Products should be stored in the warehouse on the following conditions.  
Temperature : -10°C to 40°C  
Humidity : 15% to 85% relative humidity  
No rapid change on temperature and humidity
  - Don't keep products in corrosive gases such as sulfur, chlorine gas or acid, or it may cause oxidization of electrode, resulting in poor solderability.
  - Products should be stored on the palette for the prevention of the influence from humidity, dust and so on.
  - Products should be stored in the warehouse without heat shock, vibration, direct sunlight and so on.
  - Products should be stored under the airtight packaged condition.
- (3) Delivery  
Care should be taken when transporting or handling product to avoid excessive vibration or mechanical shock.

**10.  Note**

- (1) Please make sure that your product has been evaluated in view of your specifications with our product being mounted to your product.
- (2) You are requested not to use our product deviating from the agreed specifications.
- (3) The contents of this reference specification are subject to change without advance notice. Please approve our product specifications or transact the approval sheet for product specifications before ordering.