

E/809000/* Electromechanical actuator with or without servo motor

- > Ø32 ... 100 mm
- > Robust construction
- > Cylinder based on ISO 15552
- > Maintenance-free
- > Reliable performance
- > Long life
- > Servo motors
- > Different feedback systems available
- > Holding brake available
- > Drives available with EtherCAT, PROFINET, PROFIBUS, EtherNet/IP, DeviceNet & CANopen communications
- > Wide range of accessories



Technical features

Function:

Actuator with ball screw; with or without servo motor

Standard:

Based on ISO 15552

Cylinder diameters:

32, 40, 50, 63, 80, 100 mm

Strokes:

Available 100 ... 1500 mm (short strokes < 100 mm on request)

Speed:

max. 0,2 ... 1,6 m/s (see graph page 11)

Forces F_{max} :

2,5 ... 30,4 kN (thrust force)

Motor data

Voltage:

400 VAC

Rated current:

0,7 ... 9 A

Power:

0,16 ... 3,3 kW

Drive data

Voltage:

400 VAC

Rated current:

3 ... 10,5 A

Output power:

0,75 ... 4,0 kW

Duty cycle:

100 %

Temperature:

Operating temperature actuator only:

0 ... 60 °C (32 ... 140 °F)

Ambient temperature:

Actuator:

0 ... 60 °C (32 ... 140 °F)

Motor:

0 ... 40 °C (32 ... 104 °F)

IP Protection rates:

Actuator: IP40

Motor: IP65

Standard Materials:

Barrel: Anodized aluminum

End covers: Anodized aluminum

Piston rod: Stainless steel (austenitic)

Piston rod seals: PUR

Technical data

Cylinder Ø(mm)	32		40			50			63			80				100					
Spindle diameter (mm)	12		16			20			25			32				40					
Spindle pitch (mm)	5	10	5	10	16	5	10	20	5	10	25	5	10	20	32	5	10	20	40		
Axial clearance Actuator (mm)	+ 0,02		+ 0,04			+ 0,04			+ 0,04			+ 0,04				+ 0,04			+ 0,07		
Dynamic force C (N)	5000	5100	10100	7900		13100	9700	6800	14600	14500	7400	23400	26500	16800	11400	25400	44600	33800	22800		
F max axial (N)	3000	2520	5200	4100	4200	8000	5500	3800	10150	10100	4750	20000	20000	11950	7750	24600	30400	22200	14450		
Momentum torque max (Drive shaft) (Nm)	2,4	4,0	4,2	6,5	10,8	6,4	8,8	12,2	8,1	16,1	19,0	16,0	31,9	38,1	39,6	19,6	48,4	70,7	92,2		
Orderstroke (mm)	100 ... 800		100 ... 800			100 ... 1000			100 ... 1200			100 ... 1500				100 ... 1500					
Available velocity with standard Norgren servo motor (m/s)	0,25	0,5	0,25	0,5	0,8	0,25	0,5	1,0	0,25	0,5	1,25	0,2	0,5	0,9	1,5	0,2	0,4	0,8	1,6		
Max permissible velocity (m/s)	0,6	1,3	0,5	1,0	1,6	0,4	0,8	1,5	0,3	0,6	1,5	0,2	0,5	0,9	1,5	0,2	0,4	0,8	1,6		
Max permissible rpm (1/min)	7690	7630	6470	6120	6000	4590	4660	4570	3610	3670	3640	2840	2830	2830	2820	2280	2380	2380	2370		
Acceleration max (m/s ²)	10																				
Max. angle of rotation at the piston rod (°)	0,65		0,6			0,5			0,4			0,3				0,25					

The function

The new Norgren ELION provides a high performance ball screw actuator with servo motor. The actuator can easily be configured and ordered with the Norgren online tool:

<https://www.norgren.com/uk/en/technical-support/configurators>

or visit our landing page for more information:



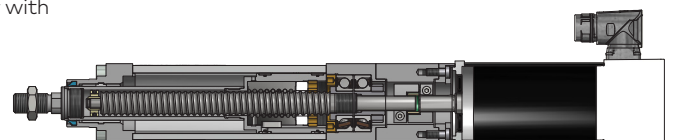

<https://www.norgren.com/uk/en/list/electric-actuators>



List of Content:

General rules	3
Cylinder Variants	4
Communications of motors, drives and bus protocols/Option Selector	7
Sizing rules and formulas	8
Permissible axial forces F _{max}	9
Permissible speeds	11
Life time information	12
Example for the selection of an electromechanical actuator	13
Basic dimensions cylinders	15
Weights, moving mass, inertia	16
Mountings and accessories	21
Basic dimensions mountings	23
Guide blocks	29
Servo Motors	34
Drives	39
Switches	40
Cable / Accessories for Drives	44

Norgren Family (Actuator ranges in the red frame are shown in this data sheet)

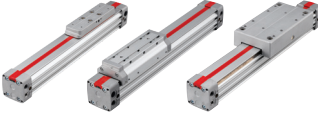
Picture	Function	Data sheet title	Data sheet number
	Electromechanical	E/809000/* Electromechanical actuator with or with or without servo motor	en 1.6.300
	Pneumatic	PRA/802000/M, RA/802000/M, RA/8000, RA/8000/M ISOLine™ 15552 cylinder, double acting	en 1.5.220
	Electromechanical	E/149000/* Electromechanical rodless spindle actuator with or without servo motor	en 1.6.400
	Electromechanical	E/148000/* Electromechanical toothed belt actuator with or without servo motor	en 1.6.500
	Pneumatic	M/146000, M/146100, M/146200, LIN-TRA®PLUS rodless cylinder Magnetic & Non-magnetic piston, double acting	en 1.6.009



Golden Rules

The Norgren ELION electric actuator is a combination of a ball screw driven actuator and an electric servo motor. Therefore, it must be ensured that the system design, installation, commissioning/start-up and maintenance are carried out by personnel who have the necessary training and competence. They must read this safety information and I&M guide carefully.

Operating conditions

The actuator can perform multiple linear positioning tasks. To prevent damage of the electromechanical actuator, lateral forces on the piston rod must be avoided, e.g. by the implementation of external guiding. Impact load on the piston rod and housing must also be avoided to prevent damage on the ball screw nut and bearings.

Actuator sizing

Ball screw drive actuators like the Norgren ELION are complex mechanical systems transferring the rotational movement of an electric motor into a linear motion. Please be advised that the technical data presented on page 1 may vary for different applications. For exact sizing, please refer to page 8, use the Norgren online configurator or contact our technical service.

Motor

The sizing of the motor depends on the load cycle applied to the actuator. At all times, the maximum torque requirements must stay below the mittlerer Lastmoment the motor can apply. To prevent overheating of the motor, the mean torque demand must be below the Dauermoment of the motor. For exact sizing, please refer to page 35 ... 38, use the Norgren online configurator or contact our technical service.

Holding brake

The motors supplied by IMI Precision Engineering can be equipped with a mechanical holding brake. While both hardware and software are designed to high standards of quality and robustness, they are not intended for use as safety functions, i.e. where a fault or failure would result in a risk of injury. Do not apply the brake while the motor shaft is rotating. The brake can only take a limited number of emergency braking operations and must not be used for repeated dynamic braking.

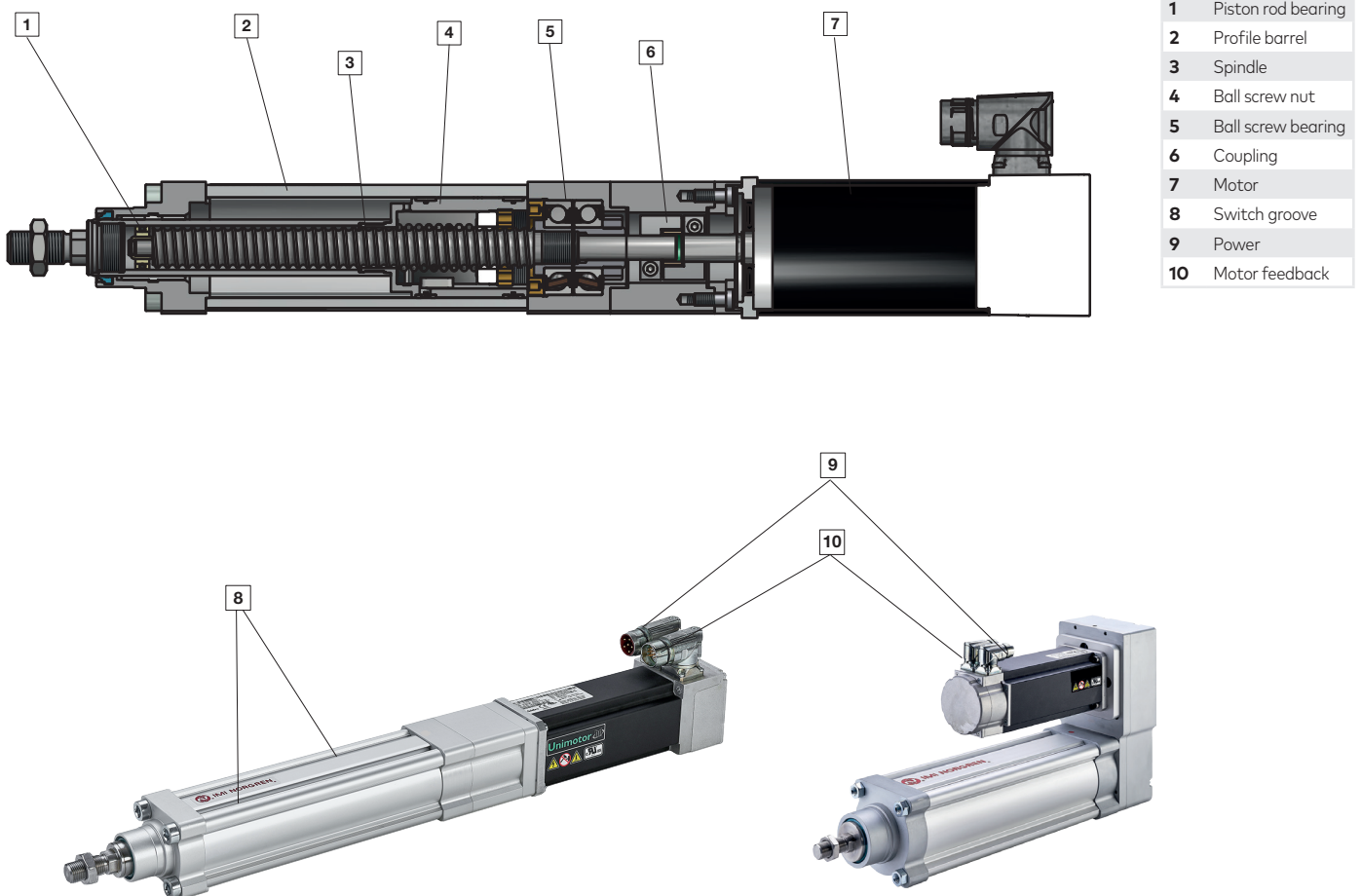

Cylinder variants
E/809**/****/****/****/******

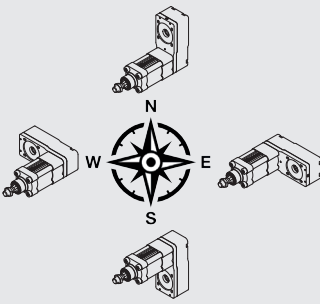
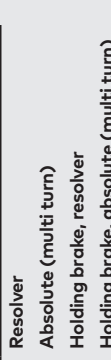
Size		Ball Screw	Variants				Motor Kit		Flange/Motor				Stroke (mm)	Piston rod extension (mm)			
Sub. 1	Sub. 2	Sub. 3	Standard	Piston rod bellows	Piston rod extension	Internal thread	Sub. 4		Sub. 5				Sub. 7	Sub. 8			
																	
Ø32	032	12x5	05	M	G	U	X	Actuator only; no coupling, no housing (see page 15)	A	No motor	X	X	100 ... 800	1 ... 200 (Use only for Variant "U" otherwise leave empty)			
								Actuator with coupling and housing for customer individual motor (see page 18)	B			07, 08, 09, *					
								Axial kit (see page 18)	D	No motor; flange □40; ØN=30; ØM=46 No motor; flange □55; ØN=40; ØM=63 Motor □55 (1,05 Nm)	X	1 2			E A B M N		
								Parallel kit - "North" (see page 19)	N	No motor; flange □40; ØN=30; ØM=46 No motor; flange □55; ØN=40; ØM=63 Motor □55 (1,05 Nm)	X	1 2			E A B M N		
								Parallel kit - "East" (see page 19)	E	No motor; flange □40; ØN=30; ØM=46 No motor; flange □55; ØN=40; ØM=63 Motor □55 (1,05 Nm)	X	1 2			E A B M N		
								Parallel kit - "South" (see page 19)	S	No motor; flange □40; ØN=30; ØM=46 No motor; flange □55; ØN=40; ØM=63 Motor □55 (1,05 Nm)	X	1 2			E A B M N		
			12x10	10													
	Ø40	040	16x5	05	M	G	U	X	Actuator only; no coupling, no housing (see page 15)	A	No motor	X			X	100 ... 800	1 ... 200 (Use only for Variant "U" otherwise leave empty)
Actuator with coupling and housing for customer individual motor (see page 18)									B			09, 12, 14, *					
Axial kit (see page 18)									D	No motor; flange □55; ØN=40; ØM=63 No motor; flange □67; ØN=60; ØM=75 Motor □55 (1,05 Nm) Motor □67 (2,45 Nm)	X	1 2	E A B M N				
Parallel kit - "North" (see page 19)									N	No motor; flange □55; ØN=40; ØM=63 No motor; flange □67; ØN=60; ØM=75 Motor □55 (1,05 Nm) Motor □67 (2,45 Nm)	X	1 2	E A B M N				
Parallel kit - "East" (see page 19)									E	No motor; flange □55; ØN=40; ØM=63 No motor; flange □67; ØN=60; ØM=75 Motor □55 (1,05 Nm) Motor □67 (2,45 Nm)	X	1 2	E A B M N				
Parallel kit - "South" (see page 19)									S	No motor; flange □55; ØN=40; ØM=63 No motor; flange □67; ØN=60; ØM=75 Motor □55 (1,05 Nm) Motor □67 (2,45 Nm)	X	1 2	E A B M N				
			16x10	10													

* For more versions please contact the technical service.

Cylinder variants
E/809★★★★/★★★★/★★★★/★★★★/★★★★

Size		Ball Screw	Variants				Motor Kit	Flange/Motor				Stroke (mm)	Piston rod extension (mm)				
Sub. 1		Sub. 2	Sub. 3	Sub. 3	Sub. 3	Sub. 4	Sub. 5	Sub. 6	Sub. 6	Sub. 6	Sub. 7	Sub. 8					
			Standard	Piston rod bellows	Piston rod extension	Internal thread	Resolver	Absolute (multi turn)	Holding brake, resolver	Holding brake, absolute (multi turn)							
Ø50	050	20x5	M	G	U	X	Actuator only, no coupling, no housing (see page 15)		A	X	X	100 ... 1000	1 ... 250 (Use only for Variant "U" otherwise leave empty)				
							Actuator with coupling and housing for customer individual motor (see page 18)		B	No motor				09, 12, 14, *			
		Axial kit (see page 18)					D	No motor, flange □67; ØN=60; ØM=75	X	1							
								Motor □67 (2,45 Nm)	J		A			B	M	N	
								Motor □67 (3,50 Nm)	N								
		Parallel kit - "North" (see page 19)					N	No motor, flange □67; ØN=60; ØM=75	X	1							
				Motor □67 (2,45 Nm)	J		A	B	M	N							
				Motor □67 (3,50 Nm)	N												
	Parallel kit - "East" (see page 19)		E	No motor, flange □67; ØN=60; ØM=75	X	1											
				Motor □67 (2,45 Nm)	J		A	B	M	N							
				Motor □67 (3,50 Nm)	N												
	Parallel kit - "South" (see page 19)		S	No motor, flange □67; ØN=60; ØM=75	X	1											
			Motor □67 (2,45 Nm)	J		A	B	M	N								
			Motor □67 (3,50 Nm)	N													
Parallel kit - "West" (see page 19)		W	No motor, flange □67; ØN=60; ØM=75	X	1												
			Motor □67 (2,45 Nm)	J		A	B	M	N								
			Motor □67 (3,50 Nm)	N													
Ø63	063	25x5	M	G	U	X	Actuator only, no coupling, no housing (see page 15)		A	X	X	100 ... 1200	1 ... 300 (Use only for Variant "U" otherwise leave empty)				
							Actuator with coupling and housing for customer individual motor (see page 18)		B	No motor				14, 18, 19, *			
		Axial kit (see page 18)					D	No motor, flange □67; ØN=60; ØM=75	X	1							
								No motor, flange □89; ØN=80; ØM=100	X	2							
								Motor □67 (2,45 Nm)	J		A			B	M	N	
								Motor □89 (6,90 Nm)	R								
	Parallel kit - "North" (see page 19)		N	No motor, flange □67; ØN=60; ØM=75	X	1											
				No motor, flange □89; ØN=80; ØM=100	X	2											
				Motor □67 (2,45 Nm)	J		A	B	M	N							
				Motor □89 (6,90 Nm)	R												
	Parallel kit - "East" (see page 19)		E	No motor, flange □67; ØN=60; ØM=75	X	1											
				No motor, flange □89; ØN=80; ØM=100	X	2											
			Motor □67 (2,45 Nm)	J		A	B	M	N								
			Motor □89 (6,90 Nm)	R													
Parallel kit - "South" (see page 19)		S	No motor, flange □67; ØN=60; ØM=75	X	1												
			No motor, flange □89; ØN=80; ØM=100	X	2												
			Motor □67 (2,45 Nm)	J		A	B	M	N								
			Motor □89 (6,90 Nm)	R													
Parallel kit - "West" (see page 19)		W	No motor, flange □67; ØN=60; ØM=75	X	1												
			No motor, flange □89; ØN=80; ØM=100	X	2												
			Motor □67 (2,45 Nm)	J		A	B	M	N								
			Motor □89 (6,90 Nm)	R													

* For more versions please contact the technical service.

Cylinder variants
E/809**/****/****/****/******

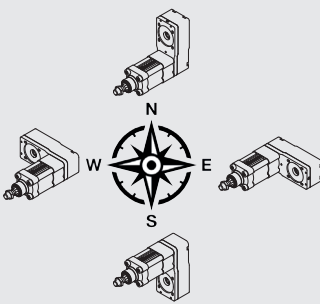
Size Sub. 1	Ball Screw Sub. 2	Variants Sub. 3	Motor Kit Sub. 4	Flange/Motor Sub. 5	Stroke (mm) Sub. 7	Piston rod extension (mm) Sub. 8					
		Standard Piston rod bellows Piston rod extension Internal thread		Resolver Absolute (multi turn) Holding brake, resolver Holding brake, absolute (multi turn)							
Ø80 080	32x5 05	M G U X	Actuator only, no coupling, no housing (see page 15)	A	X X	100 ... 1500	1 ... 350 (Use only for Variant "U" otherwise leave empty)				
			Actuator with coupling and housing for customer individual motor (see page 18)	B	14, 18, 19, *						
			Axial kit (see page 18)	D	No motor, flange □67; ØN=60; ØM=75 No motor, flange □89; ØN=80; ØM=100 Motor □67 (3,50 Nm) Motor □89 (6,90 Nm)			X 1 N 2 R A B M N			
				Parallel kit - "North" (see page 19)	N			No motor, flange □67; ØN=60; ØM=75 No motor, flange □89; ØN=80; ØM=100 Motor □67 (3,50 Nm) Motor □89 (6,90 Nm)	X 1 N 2 R A B M N		
					E			No motor, flange □67; ØN=60; ØM=75 No motor, flange □89; ØN=80; ØM=100 Motor □67 (3,50 Nm) Motor □89 (6,90 Nm)	X 1 N 2 R A B M N		
				Parallel kit - "South" (see page 19)	S			No motor, flange □67; ØN=60; ØM=75 No motor, flange □89; ØN=80; ØM=100 Motor □67 (3,50 Nm) Motor □89 (6,90 Nm)	X 1 N 2 R A B M N		
	Parallel kit - "West" (see page 19)		W	No motor, flange □67; ØN=60; ØM=75 No motor, flange □89; ØN=80; ØM=100 Motor □67 (3,50 Nm) Motor □89 (6,90 Nm)	X 1 N 2 R A B M N						
	32x10 10		32x20 20	32x32 32	Actuator only, no coupling, no housing (see page 15)			A	X X		
					Actuator with coupling and housing for customer individual motor (see page 18)			B	19, 22, 24, *		
					Axial kit (see page 18)			D	No motor, flange □89; ØN=80; ØM=100 No motor, flange □115; ØN=110; ØM=130 Motor □89 (6,90 Nm) Motor □115 (10,50 Nm)	X 1 N 2 R A B M N	
								Parallel kit - "North" (see page 19)	N	No motor, flange □89; ØN=80; ØM=100 No motor, flange □115; ØN=110; ØM=130 Motor □89 (6,90 Nm) Motor □115 (10,50 Nm)	X 1 N 2 R A B M N
									E	No motor, flange □89; ØN=80; ØM=100 No motor, flange □115; ØN=110; ØM=130 Motor □89 (6,90 Nm) Motor □115 (10,50 Nm)	X 1 N 2 R A B M N
Parallel kit - "South" (see page 19)		S				No motor, flange □89; ØN=80; ØM=100 No motor, flange □115; ØN=110; ØM=130 Motor □89 (6,90 Nm) Motor □115 (10,50 Nm)	X 1 N 2 R A B M N				
Parallel kit - "West" (see page 19)	W	No motor, flange □89; ØN=80; ØM=100 No motor, flange □115; ØN=110; ØM=130 Motor □89 (6,90 Nm) Motor □115 (10,50 Nm)	X 1 N 2 R A B M N								

* For more versions please contact the technical service.

Sizing Rules and Formulas

1. Definition of the load cycle

The load cycle includes all movements of the actuator. For every step, the following values must be defined:

- Direction of the movement
- End position of the movement
- External load mass
- Friction coefficient of a possible external guiding
- Acceleration and deceleration
- Maximum velocity
- Constant external forces
- Possible pause times at the end of the movement

Due to the high positioning accuracy of the Norgren ELION actuators, the number of steps in one cycle is not limited.

2. Calculation of the forces acting on the actuator

For a basic selection of the actuator, the knowledge of the acting forces during the load cycle is essential. For each movement of the load, the total force must be calculated. The total force F_{tot} can be calculated as the sum of the inertial force F_I , external friction forces F_{fr} , the gradient force F_{gr} caused by moving a mass against gravity and possible constant external forces F_{const} .

$$F_{tot} = F_I + F_{fr} + F_{gr} + F_{const}$$

The forces can be calculated as follows:

$$F_I = -(m_{mov,act} + m_{load}) \cdot a$$

$$F_{fr} = -\text{sign}(\Delta x) \cdot \mu \cdot |\cos(\varphi) \cdot (m_{mov,act} + m_{load}) \cdot g|$$

$$F_{gr} = \sin(\varphi) \cdot (m_{mov,act} + m_{load}) \cdot g$$

a	Acceleration/deceleration	m/s^2
$m_{mov,act}$	Moving mass of the actuator	kg
m_{load}	Load mass applied on actuator	kg
Δx	Stroke of each movement	m
φ	Direction of the movement	°
μ	Friction coefficient	-
g	Gravitational acceleration	m/s^2

3. Selection of the actuator

3.1 Safety stroke

Disregarding the initial set up, the actuator must not touch its mechanical end stops.

A safety stroke should be considered, respecting the application boundaries and environments.

We generally recommend a safety stroke of 20 mm per side for electric actuators.

The order stroke = working stroke + safety stroke of 2 x 20 mm.

3.2 Spindle pitch

The pitch of the driving spindle can be defined by the maximum velocity of the load

$$v_{cycle} \leq v_{max,actuator}$$

The correlation between the maximum stroke length and the maximum velocity of the actuator must be considered as well as the different spindle pitch values defining the maximum velocity.

Using the values for stroke length and velocity, the maximum force necessary during the load cycle can be compared to the maximum force applicable to the actuator. Here, the direction of movement has to be considered to prevent buckling of the cylinder rod and spindle.

$$F_{tot,max} < F_{max,actuator}$$

In general, side loads on the actuator should be avoided. If lateral forces appear, an external guiding system must be applied!

4. Selection of a motor

For each actuator, two motor sizes are available. The selection of the motor is based on the driving torque T and rotational speed rpm which have to be calculated for each step of the load cycle. All values calculated must be below the intermittent torque the motor can deliver (diagr. p. 35 to 38).

$$T = F_{tot,step} \cdot \frac{P_{spindle}}{2\pi \cdot 0.85}$$

$$rpm = \frac{v_{max,step}}{P_{spindle}} \cdot 60000$$

T	Torque	Nm
rpm	Rotational speed	min^{-1}
$v_{max,step}$	Maximum velocity of each step	m/s
$P_{spindle}$	Spindle pitch	mm

To avoid overheating of the motor, the mean torque T_{rms} of the load cycle must be lower than the continuous torque (diagr. p. 35 to 38).

$$T_{rms} = \sqrt{\sum \left(\frac{F_{tot,step} \cdot P_{spindle}}{2\pi \cdot 0.85} \right)^2 \cdot \frac{t_{step}}{t_{tot}}}$$

$$rpm_{rms} = \sqrt{\sum (rpm_{step})^2 \cdot \frac{t_{step}}{t_{tot}}}$$

5. Estimation of expected life time

The estimated life time of the ball screw drive can be calculated according to DIN ISO 3408-5. Therefore, the mean velocity v_m and the mean force F_m must be calculated.

$$F_m = \sqrt[3]{\sum_{j=1}^n \left(|F_{tot,step,j}|^3 \cdot \frac{|v_{step,j}| \cdot t_{step,j}}{v_m \cdot t_{tot}} \right)}$$

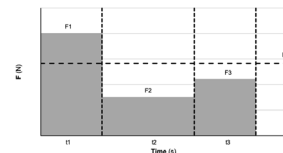

Then, the life time in revolutions is calculated from the dynamic force C of the ball screw nut and the mean force.

$$L = \left(\frac{C}{F_m} \right)^3 \cdot 10^6$$

The life time L_{km} in km is then calculated with the spindle pitch P .

$$L_{km} = L \cdot P \cdot 10^{-6}$$

For more information please visit:

<https://www.norgren.com/uk/en/list/electric-actuators>

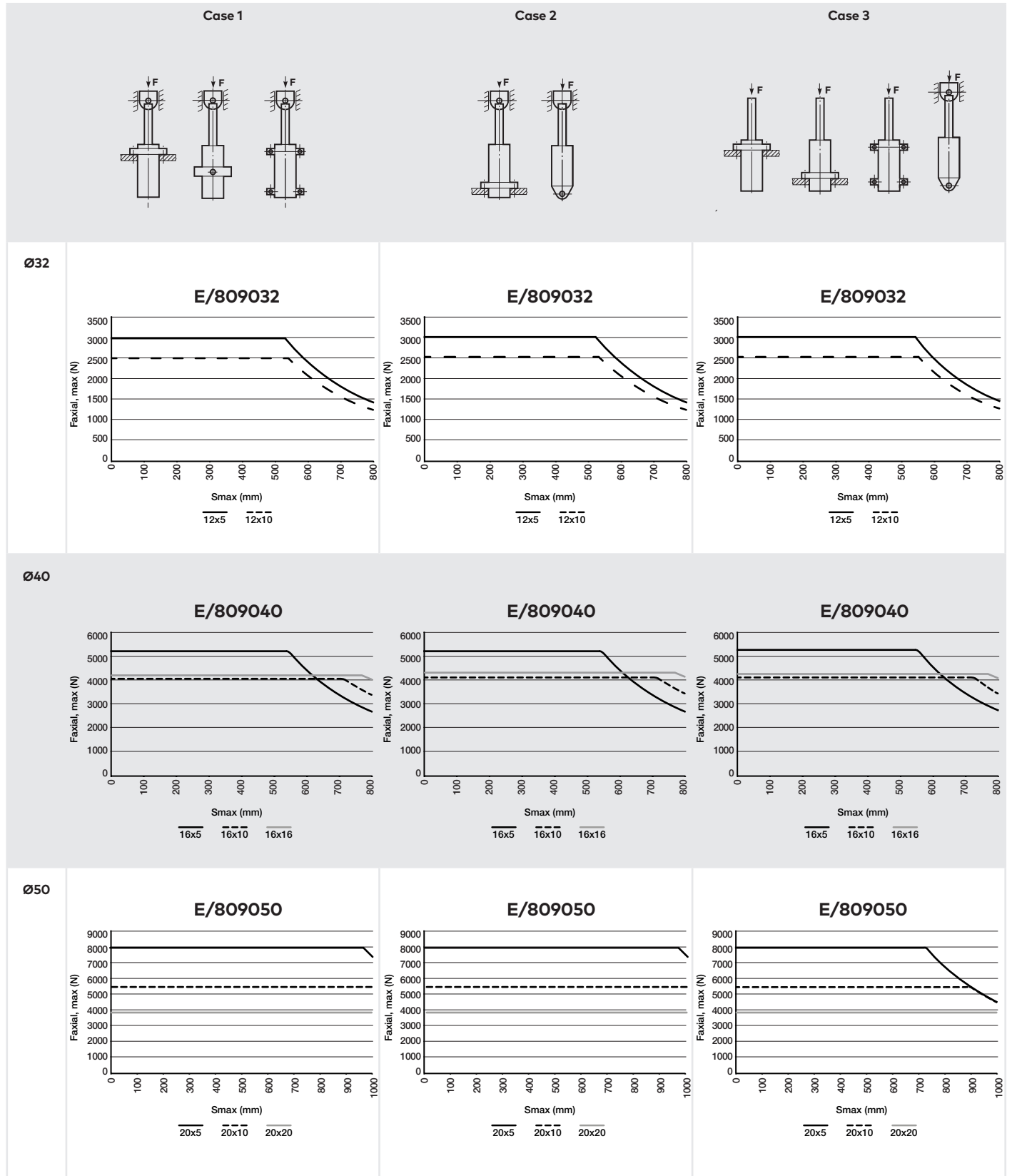
Cylinder variants
Permissible axial forces F_{max}

Cylinder variants
Permissible axial forces F_{max}

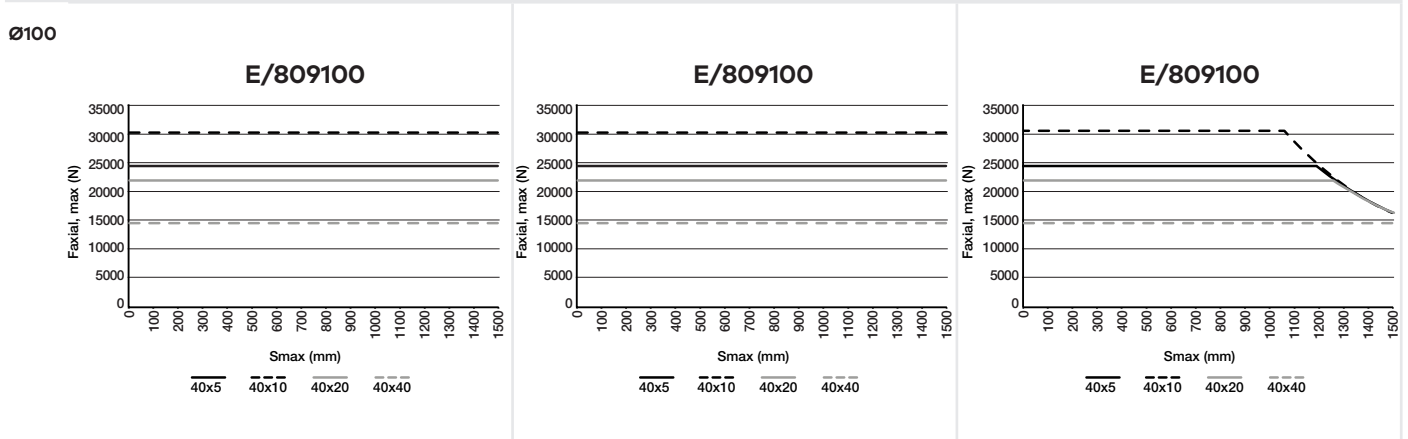
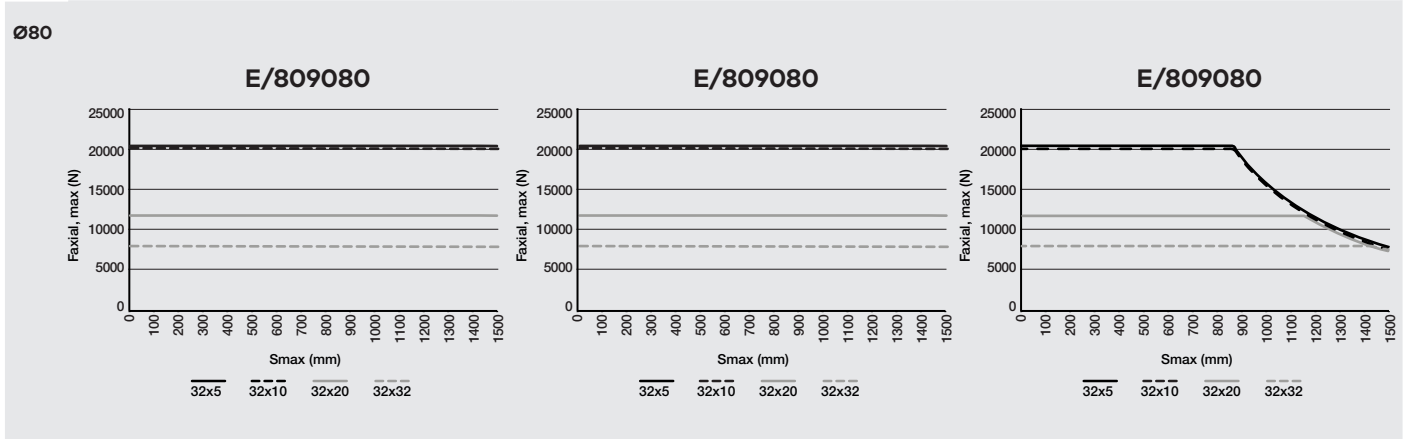
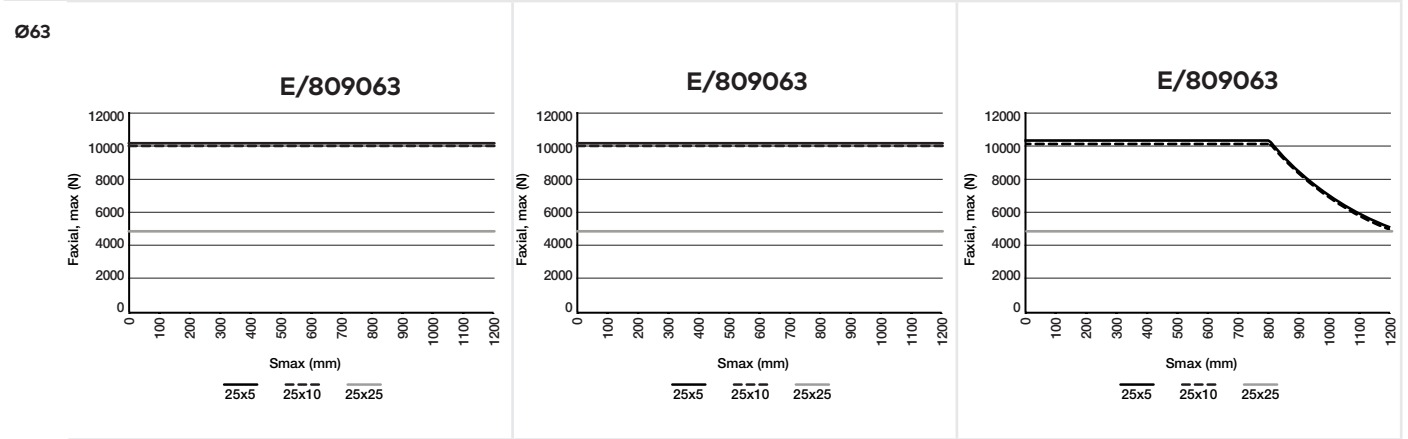
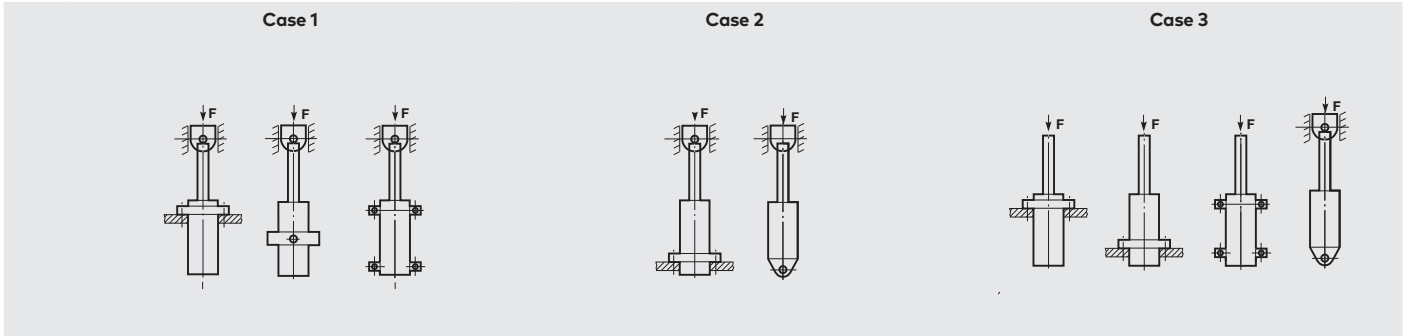

Permissible Speeds

E/809032

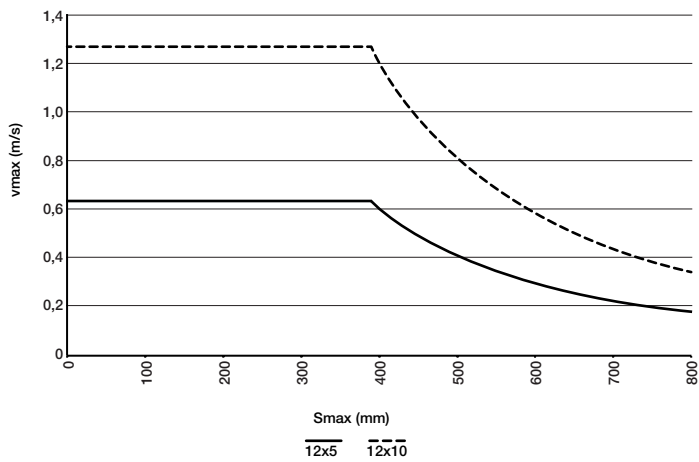

E/809040

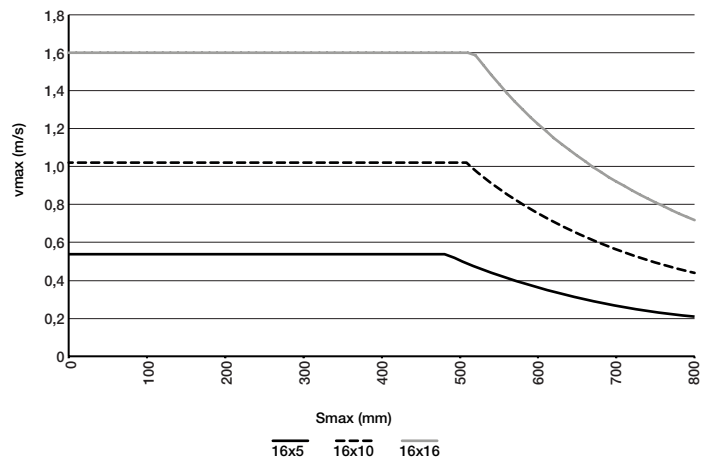

E/809050

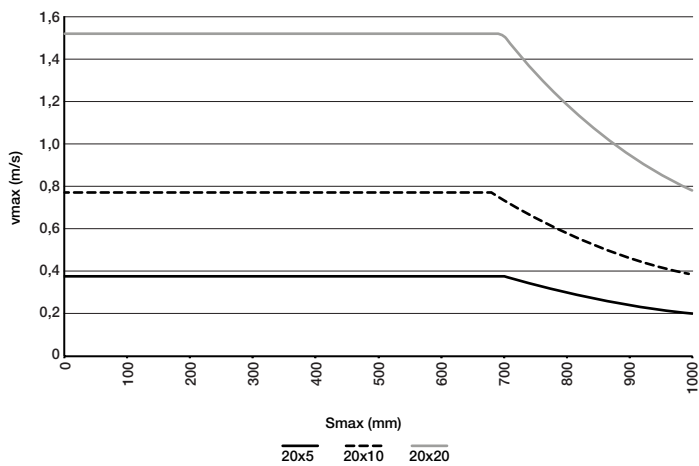

E/809063

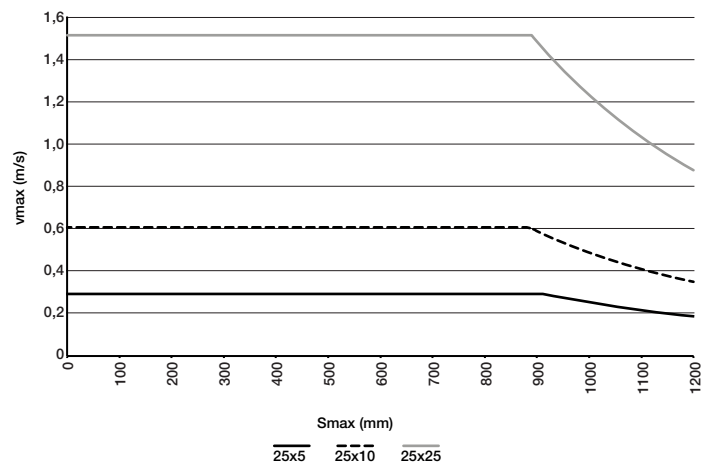

E/809080

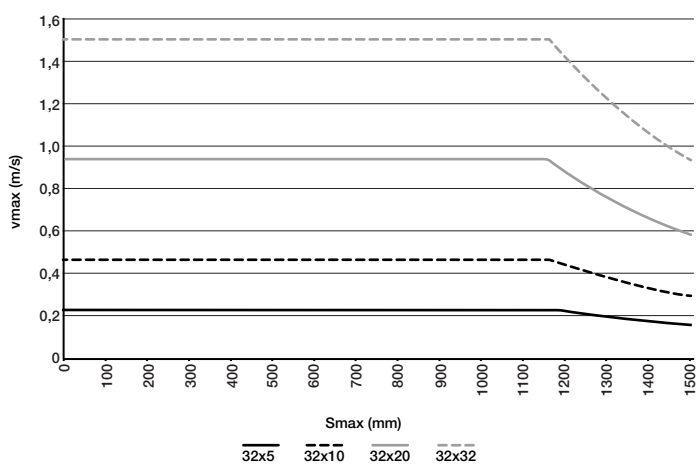

E/809100

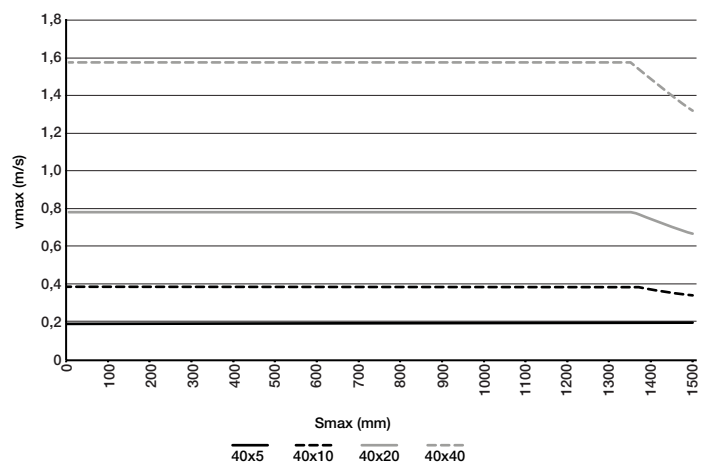

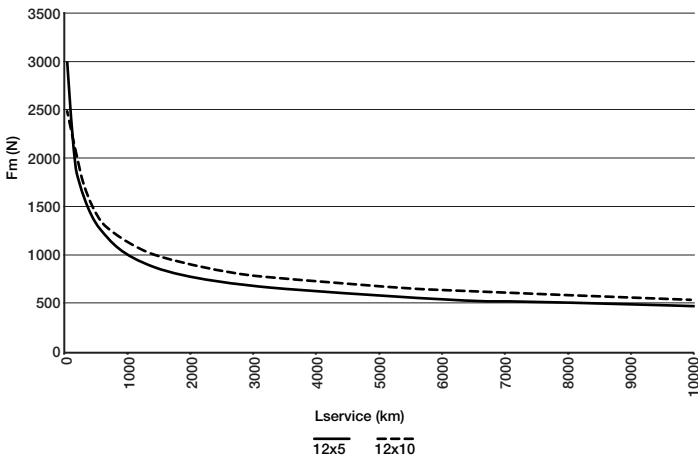
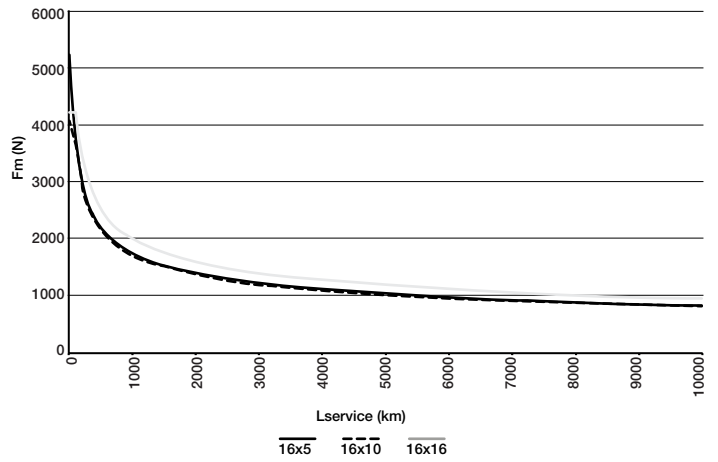
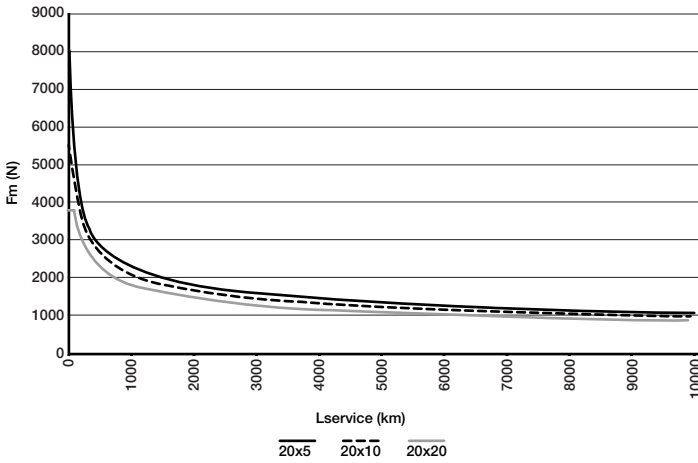
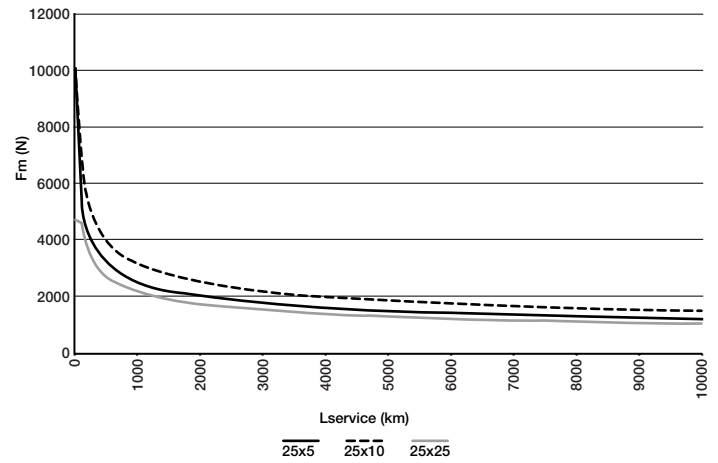
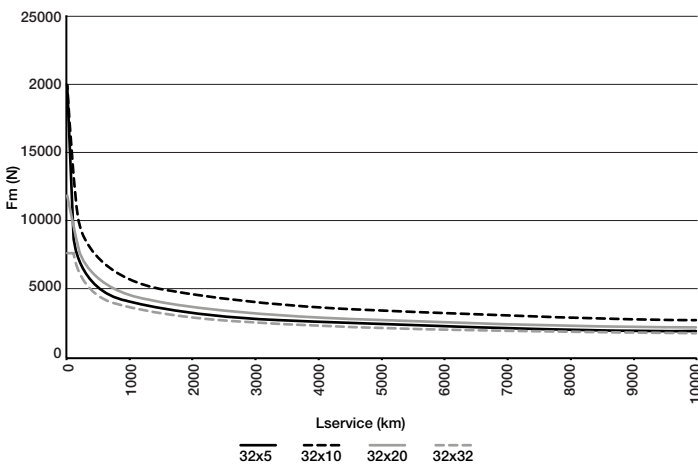
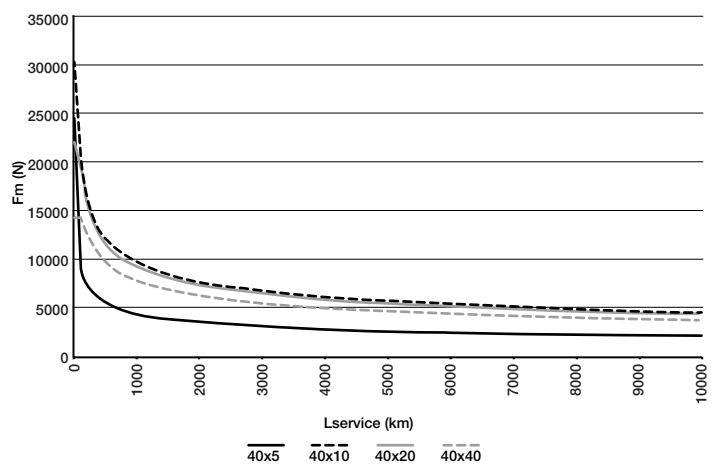
Force Life Time
E/809032

E/809040

E/809050

E/809063

E/809080

E/809100

Example for the selection of an electromechanical actuator

A mass of 95 kg is to be pulled 850 mm upwards at an angle of 60° by a device (5 kg). The instroke time is nine seconds. The mass is removed from the device at the upper position (pause 2 s); the device is then lowered again within three seconds. After another three seconds, the cycle starts again.

The ambient temperature is between 20 and 35 °C. There are no special material requirements. The device is not externally guided. The expected service life is approx. 1,000,000 load cycles.

Step 1: Overview of the technical parameters

a) Weight of the load to be lifted (instroke)	F_1	$= (95 \text{ kg} + 5 \text{ kg}) \times 10 \text{ m/s}^2 =$	1000 N
b) Weight of the load to be lifted (outstroke)	F_2	$= 5 \text{ kg} \times 10 \text{ m/s}^2 =$	50 N
c) Required stroke length	s		850 mm
d) Load case	\mathcal{L}	Non-guided	3
e) Ambient temperature	T'_{max}		35 °C
f) Material requirements			keine
g) Maximum speed (instroke)	v_1	$= \frac{\Delta x}{\frac{1}{3} t_{\text{ein}}} =$	0,142 m/s
h) Maximum speed (outstroke)	v_2	$= \frac{\Delta x}{\frac{1}{3} t_{\text{aus}}} =$	0,425 m/s
i) Mean speed	v_m	$= \sum_{j=1}^n \frac{t_j}{t_{\text{tot}}} \cdot v_j =$	0,106 m/s
j) Mean Force	F_m	$= \sqrt[3]{\sum_{j=1}^n \left(F_j^3 \cdot \frac{v_j}{v_m} \cdot t_j / t_{\text{tot}} \right)} =$	795 N
k) Life expectancy in load cycles	$\mathcal{L}_{\text{zykl}}$		1.000.000
l) Life expectancy in km	\mathcal{L}_{km}	$\frac{1.000.000 \times (850 \text{ mm})}{1.000.000 \text{ km/(mm)} \times 2}$	1.700 km

Step 2: Selection of suitable actuators based on the working stroke

The maximum permissible order strokes for the individual actuators can be found in the table "Technical data" on page 1 of the data sheet. Size 32 and 40 have insufficient stroke for this application.

Cylinder Ø(mm)	32		40			50			63			80				100				
Spindle diameter (mm)	12		16			20			25			32				40				
Spindle pitch (mm)	5	10	5	10	16	5	10	20	5	10	25	5	10	20	32	5	10	20	40	
Axial clearance Actuator (mm)	+ 0,02		+ 0,04			+ 0,04			+ 0,04			+ 0,04				+ 0,07				
Dynamic force C (N)	5000	5100	10100	7900			13100	9700	6800	14600	14500	7400	23400	26500	16800	11400	25400	44600	33800	22800
F max axial (N)	3000	2520	5200	4100	4200	8000	5500	3800	10150	10100	4750	20000	20000	11950	7750	24600	30400	22200	14450	
Momentum torque max (Drive shaft) (Nm)	2,8	4,7	4,9	7,7	12,7	7,5	10,3	14,3	9,5	18,9	22,4	18,8	37,5	44,8	46,6	23,1	56,9	83,1	108,4	
Orderstroke (mm)	100 ... 800		100 ... 800			100 ... 1000			100 ... 1200			100 ... 1500				100 ... 1500				
Velocity/speed max (m/s)	0,6	1,3	0,5	1,0	1,6	0,4	0,8	1,5	0,3	0,6	1,5	0,2	0,5	0,9	1,5	0,2	0,4	0,8	1,6	
RPM max spindle (1/min)	7690	7630	6470	6120	6000	4590	4660	4570	3610	3670	3640	2840	2830	2830	2820	2280	2380	2380	2370	
Acceleration max (m/s ²)	10																			
Max. angle of rotation at the piston rod (°)	0,65°		0,6°			0,5°			0,4°			0,3°				0,25°				

Step 3: Selection of suitable actuators based on the maximum permissible forces

The maximum permissible force depends on the order stroke and can be taken from the diagrams on pages 9 to 10 of the data sheet. This application is installed according to "Load case 3". This means that all drives from size 50 are suitable for the applicatio

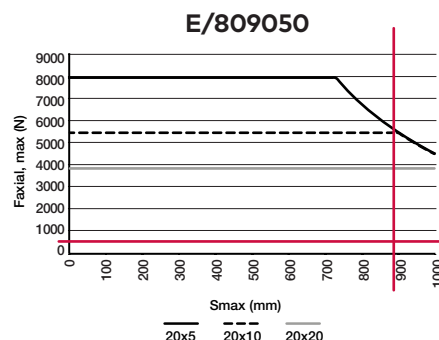

Step 4: Selection of suitable actuators based on the maximum permissible speed

The maximum permissible speed depends on the order stroke and can be taken from the diagrams on page 11 of the data. The spindle 20x5 mm is omitted.

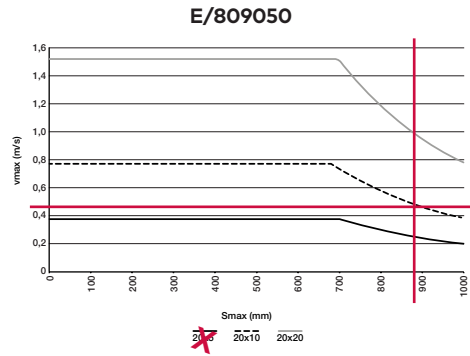

Step 5: Selection of suitable actuators based on estimated service life

The mean force acting on the actuator is used to calculate the service life. The mean force F_m can be calculated using the formula on page 8. With an average force of 795 N, a service life of > 1,700 km can be expected.

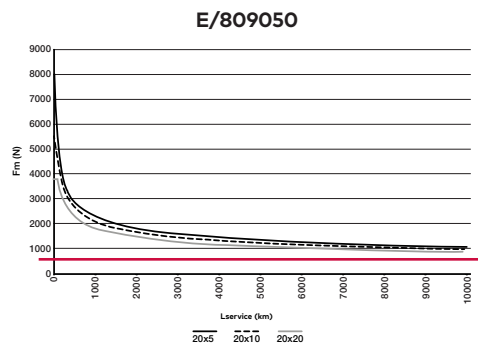

Step 6: Selection of the appropriate order stroke (working stroke + stroke reserve)

To prevent damage to the actuator, a stroke reserve of at least 20 mm is recommended at each end side:

$$\begin{aligned}
 \text{Order stroke} &= \text{working stroke} + 2 \times 20 \text{ mm} \\
 &= 850 \text{ mm} + 40 \text{ mm} \\
 &= \mathbf{890 \text{ mm}}
 \end{aligned}$$

Step 7: Check all remaining parameters

- e) temperature requirement of $T_{max} = 35 \text{ }^\circ\text{C}$ is met
- h) there are no specific requirements for the material

Result:

E/809050/10M/890 is the chosen electromechanical actuator, because it meets all requirements.

Basic dimensions
E/809000/M/AXX, E/809000/**U/AXX**
Standard cylinder without motor, no coupling, no housing

Dimensions in mm
 Projection/First angle

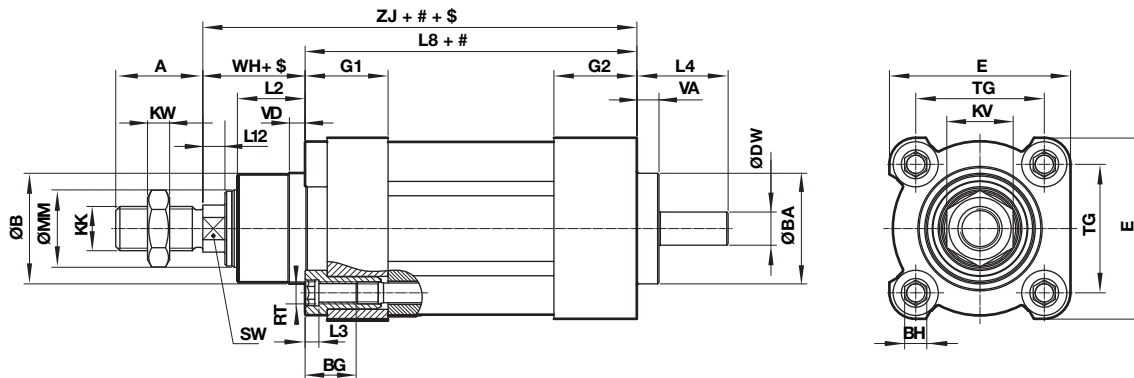

E/809080 & E/809100

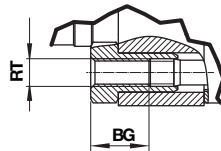

#Stroke
 \$ = piston rod extension

Ø	A-1	ØB d11	ØBA g6	BG min	BH	ØDW f7	E	G1	G2	KK	KV	KW	L2	L3 max	L4	L8	L12	ØMM h9
32	22	30	30	16	6	7	47	27	32	M10 x 1,25	17	5	15,5	4	24	107 ±0,4	5,5	20
40	24	35	35	16	6	9	55	27	37	M12 x 1,25	19	6	17,5	4	27,5	130,5 ±0,7	6,5	25
50	32	40	40	16	8	12	65,5	30	41	M16 x 1,5	24	8	24,5	5	33	131 ±0,7	8	28
63	32	45	50	16	8	14	74,5	30	49	M16 x 1,5	24	8	24,5	5	37,5	160 ±0,8	8	32
80	40	55	60	17	19	18	95	34	50,5	M20 x 1,5	30	10	30,5	-	39,5	184,5 ±0,8	10	40
100	40	70	72	17	19	22	113	41	57,5	M20 x 1,5	30	10	33,5	-	45,5	214,5 ±1	10	50

Ø	RT	SW	TG	VA	VD	WH (mech. end stop)	ZJ	Model
32	M6	10	32,5 ±0,5	7	6	26 ±1,4	133	E/809032/05*/AXX
								E/809032/10*/AXX
								E/809040/05*/AXX
40	M6	13	38 ±0,5	7	6	30 ±1,4	160,5	E/809040/10*/AXX
								E/809040/16*/AXX
								E/809050/05*/AXX
50	M8	17	46,5 ±0,6	8	6	37 ±1,4	168	E/809050/10*/AXX
								E/809050/20*/AXX
								E/809063/05*/AXX
63	M8	17	56,5 ±0,7	8	6	37 ±1,8	197	E/809063/10*/AXX
								E/809063/25*/AXX
								E/809080/05*/AXX
80	M10	22	72 ±0,7	9	6	46 ±1,8	230,5	E/809080/10*/AXX
								E/809080/20*/AXX
								E/809080/32*/AXX
								E/809100/05*/AXX
100	M10	22	89 ±0,7	9	6	51 ±1,8	265,5	E/809100/10*/AXX
								E/809100/20*/AXX
								E/809100/40*/AXX

Weights, moving mass, inertia
E/809000/M/AXX, E/809000/**U/AXX**
Standard cylinder without motor, no coupling, no housing

Ø	32		40			50		
	5	10	5	10	16	5	10	20
Ball screw pitch (mm)	5	10	5	10	16	5	10	20
Weight at zero stroke (kg)	0,81	0,79	1,25	1,26	1,32	2,04	2,07	2,10
Weight per 100 mm stroke (kg / mm)	0,40	0,40	0,52	0,53	0,53	0,77	0,78	0,78
Moving mass at zero stroke (kg)	0,27	0,26	0,39	0,39	0,44	0,64	0,67	0,70
Moving mass per 100 mm stroke (kg / mm)	0,13	0,13	0,16	0,16	0,16	0,19	0,19	0,19
Rotating mass at zero stroke (kg)	0,14	0,14	0,27	0,28	0,28	0,46	0,47	0,47
Rotating mass per 100 mm stroke (kg / mm)	0,10	0,10	0,10	0,10	0,10	0,20	0,20	0,20
Mass moment of inertia at zero stroke (kg mm ²)	3,50	5,40	8,40	11,41	15,96	24,92	26,49	35,01
Mass moment of inertia per 100 mm stroke (kg mm ² / mm)	1,50	1,70	3,00	4,00	4,90	10,70	11,10	12,70
Mass moment of inertia per 1 kg load (kg mm ² / kg)	0,63	2,53	0,63	2,53	6,48	0,63	2,53	10,13

Ø	63			80				100			
	5	10	25	5	10	20	32	5	10	20	40
Ball screw pitch (mm)	5	10	25	5	10	20	32	5	10	20	40
Weight at zero stroke (kg)	3,22	3,30	3,33	5,79	5,94	6,05	6,04	9,82	9,85	9,99	10,18
Weight per 100 mm stroke (kg / mm)	1,00	1,00	1,00	1,50	1,50	1,50	1,50	2,10	2,00	2,00	2,00
Moving mass at zero stroke (kg)	0,96	1,04	1,07	1,90	2,03	2,14	2,14	3,11	3,34	3,48	3,66
Moving mass per 100 mm stroke (kg / mm)	0,20	0,20	0,20	0,30	0,30	0,30	0,30	0,50	0,50	0,50	0,50
Rotating mass at zero stroke (kg)	0,96	0,97	0,97	1,60	1,61	1,61	1,60	2,77	2,58	2,58	2,59
Rotating mass per 100 mm stroke (kg / mm)	0,30	0,40	0,30	0,60	0,60	0,60	0,60	0,90	0,80	0,80	0,80
Mass moment of inertia at zero stroke (kg mm ²)	80,42	80,00	94,66	211,96	204,13	226,95	243,13	558,98	503,78	512,54	545,99
Mass moment of inertia per 100 mm stroke (kg mm ² / mm)	28,30	28,20	31,20	75,30	71,70	81,10	85,60	179,90	149,00	152,30	166,60
Mass moment of inertia per 1 kg load (kg mm ² / kg)	0,63	2,53	15,83	0,63	2,53	10,13	25,94	0,63	2,53	10,13	40,53

Basic dimensions
E/809000/X/AXX**
Cylinder with internal piston thread without motor, no coupling, no housing

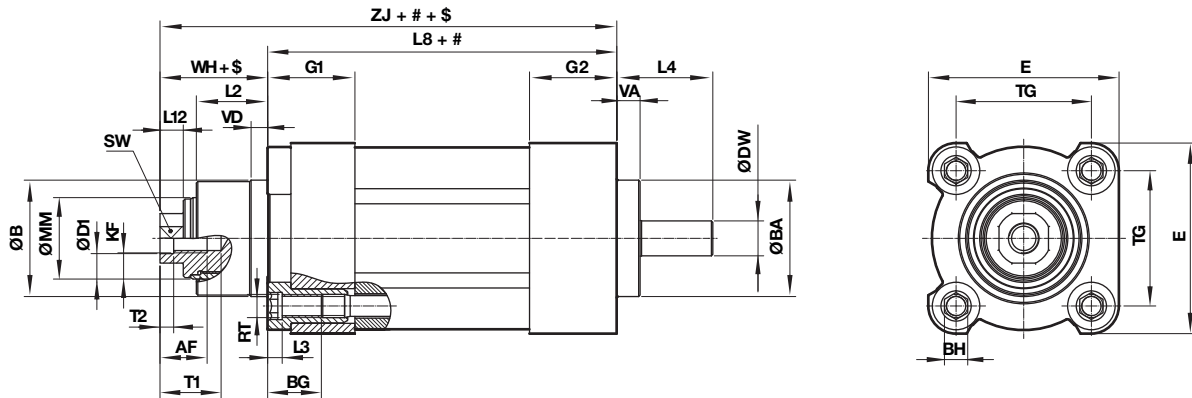
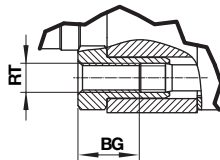
 Dimensions in mm
 Projection/First angle

E/809080 & E/809100

 #Stroke
 \$ = piston rod extension

Ø	AF ₋₁	ØB _{d11}	ØBA _{g6}	BG _{min}	BH	ØD1	ØDW _{f7}	E	G1	G2	KF	L2	L3 _{max}	L4	L8	L12	ØMM _{h9}
32	12	30	30	16	6	6,4	7	47	27	32	M6	15,5	4	24	107 ±0,4	5,5	20
40	12	35	35	16	6	8,4	9	55	27	37	M8	17,5	4	27,5	130,5 ±0,7	6,5	25
50	16	40	40	16	8	10,5	12	65,5	30	41	M10	24,5	5	33	131 ±0,7	8	28
63	16	45	50	16	8	10,5	14	74,5	30	49	M10	24,5	5	37,5	160 ±0,8	8	32
80	20	55	60	17	19	13	18	95	34	50,5	M12	30,5	-	39,5	184,5 ±0,8	10	40
100	20	70	72	17	19	13	22	113	41	57,5	M12	33,5	-	45,5	214,5 ±1	10	50

Ø	RT	SW	T1	T2	TG	VA	VD	WH (mech. end stop)	ZJ	Model
32	M6	10	16	2,6	32,5 ±0,5	7	6	26 ±1,4	133	E/809032/05X/AXX
										E/809032/10X/AXX
										E/809040/05X/AXX
40	M6	13	16	3,3	38 ±0,5	7	6	30 ±1,4	160,5	E/809040/10X/AXX
										E/809040/16X/AXX
										E/809050/05X/AXX
50	M8	17	21	4,7	46,5 ±0,6	8	6	37 ±1,4	168	E/809050/10X/AXX
										E/809050/20X/AXX
										E/809063/05X/AXX
63	M8	17	21	4,7	56,5 ±0,7	8	6	37 ±1,8	197	E/809063/10X/AXX
										E/809063/25X/AXX
										E/809080/05X/AXX
80	M10	22	25	6,1	72 ±0,7	9	6	46 ±1,8	230,5	E/809080/10X/AXX
										E/809080/20X/AXX
										E/809080/32X/AXX
										E/809100/05X/AXX
100	M10	22	25	6,1	89 ±0,7	9	6	51 ±1,8	265,5	E/809100/10X/AXX
										E/809100/20X/AXX
										E/809100/40X/AXX

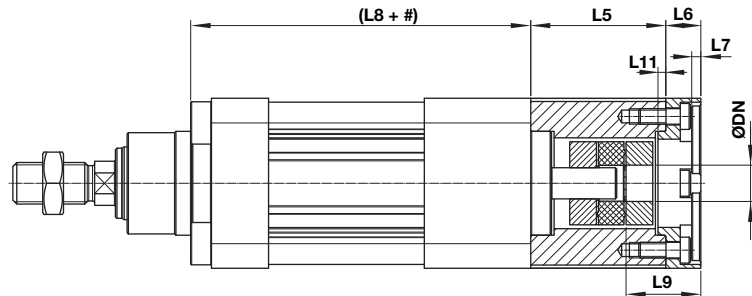
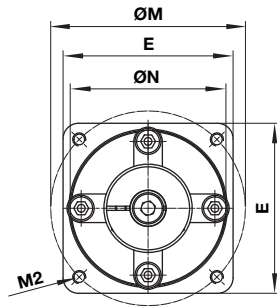
Basic dimensions
E/809000/*/D****
Standard actuator with axial motor mounting kit

Dimensions in mm
 Projection/First angle



Ø	ØDN H7	E	L5	L6	L7	L8	L9	L11	M2	ØN G7	ØM	#Stroke	Weight motor mounting kit (kg)	Model
32	8	47	39	11,5	3	107 ±0,4	22	2	M4	30	46	0,25		E/809032/***/DX1
32	9	53	39	9	3	107 ±0,4	19,5	2	M5	40	63	0,25		E/809032/***/DX2
32	9	53	39	9	3	107 ±0,4	19,5	2	M5	40	63	0,25		E/809032/***/DE*
40	9	55	42	10	3	130,5 ±0,7	20,3	2	M5	40	63	0,34		E/809040/***/DX1
40	9	55	42	10	3	130,5 ±0,7	20,3	2	M5	40	63	0,34		E/809040/***/DE*
40	14	65,5	42	18,5	3,5	130,5 ±0,7	28,8	2	M5	60	75	0,42		E/809040/***/DX2
40	14	65,5	42	18,5	3,5	130,5 ±0,7	28,8	2	M5	60	75	0,42		E/809040/***/DJ*
50	14	65,5	52	13,5	3,5	131 ±0,7	28,8	3	M5	60	75	0,64		E/809050/***/DX1
50	14	65,5	52	13,5	3,5	131 ±0,7	28,8	3	M5	60	75	0,64		E/809050/***/DJ*
50	14	65,5	52	13,5	3,5	131 ±0,7	28,8	3	M5	60	75	0,64		E/809050/***/DN*
63	14	75	61	12	3	160 ±0,8	29	2	M5	60	75	0,90		E/809063/***/DX1
63	14	75	61	12	3	160 ±0,8	29	2	M5	60	75	0,90		E/809063/***/DJ*
63	19	85	61	22	3,5	160 ±0,8	39	2	M6	80	100	1,05		E/809063/***/DX2
63	19	85	61	22	3,5	160 ±0,8	39	2	M6	80	100	1,05		E/809063/***/DR*
80	14	95	64	13,5	3,5	184,5 ±0,8	29,5	3	M5	60	75	1,60		E/809080/***/DX1
80	14	95	64	13,5	3,5	184,5 ±0,8	29,5	3	M5	60	75	1,60		E/809080/***/DN*
80	19	95	64	22	3,5	184,5 ±0,8	38	3	M6	80	100	1,70		E/809080/***/DX2
80	19	95	64	22	3,5	184,5 ±0,8	38	3	M6	80	100	1,70		E/809080/***/DR*
100	19	115,8	75	14	3,5	214,5 ±1	39	3	M6	80	100	2,50		E/809100/***/DX1
100	19	115,8	75	14	3,5	214,5 ±1	39	3	M6	80	100	2,50		E/809100/***/DR*
100	24	115,8	75	24	3,5	214,5 ±1	49	3	M8	110	130	2,70		E/809100/***/DX2
100	24	115,8	75	24	3,5	214,5 ±1	49	3	M8	110	130	2,70		E/809100/***/DW*

Basic dimensions
E/809000/*/B****
Standard actuator with coupling and housing for customer individual motor flange

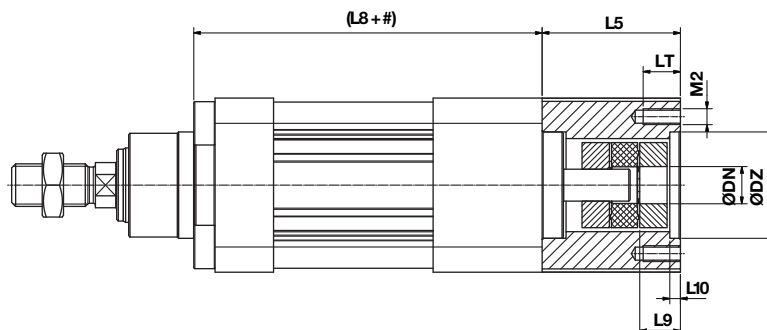
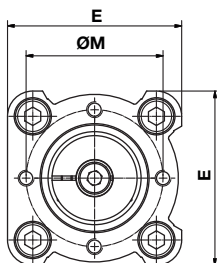

Ø	ØDN H7	ØDZ H7	E	L5	L9	L10	LT	M2	ØM	#Stroke	Weight motor mounting kit (kg)	Model
32	7, 8, 9**	30	47	39	11	3	10	M4	36	0,20		E/809032/***/B**
40	9, 12, 14**	37	55	42	10,3	3	10	M4	44	0,28		E/809040/***/B**
50	9, 12, 14**	40	65,5	52	15,3	4	14	M6	51,5	0,52		E/809050/***/B**
63	14, 18, 19**	50	74,5	61	17	3	14	M6	60	0,75		E/809063/***/B**
80	14, 18, 19**	60	95	64	16	4	17	M6	76	1,30		E/809080/***/B**
100	19, 22, 24**	72	113	75	25	4	17	M8	90,5	2,10		E/809100/***/B**

Basic dimensions
E/809000/*/NX*, E/809000/***/EX*, E/809000/***/SX*, E/809000/***/WX***
Standard actuator with parallel motor mounting kit

Dimensions in mm

Projection/First angle

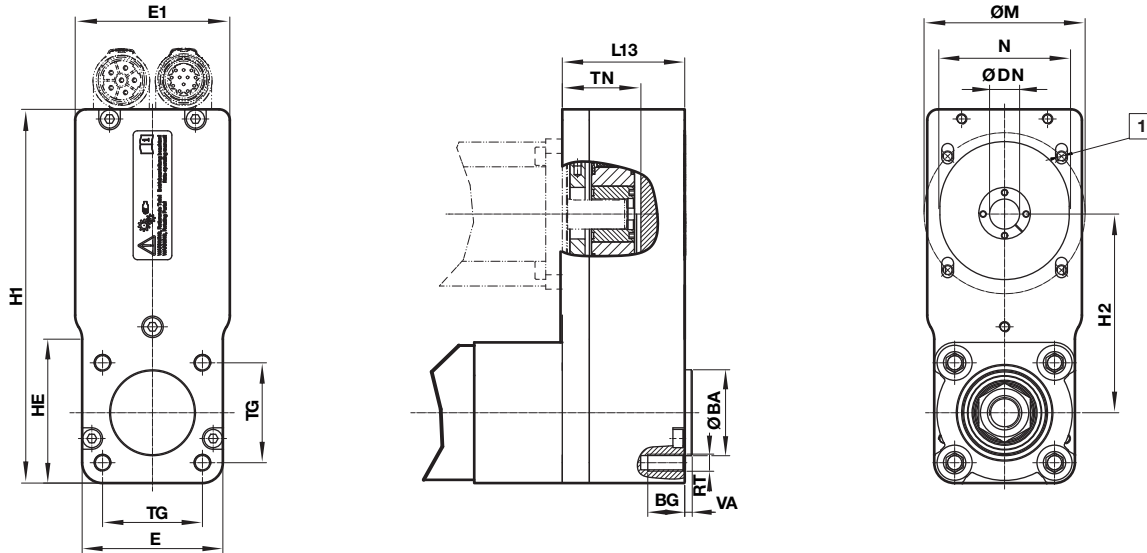

1 M2 - T2 deep

Ø	ØBA d11	BG _{min}	DN	E	E1	H1	H2	HE	L13	M2	ØM	N	RT	T2	TG	TN	VA	Weight (kg)	Model
32	30	16	8	47	56	130,6	67,5	48	46,5	M4	46	30	M6	11	32,5 ±0,5	max. 28	3,5	0,75	E/809032/***/X1
32	30	16	8	47	56	130,6	67,5	48	46,5	M5	63	40	M6	11	32,5 ±0,5	20 ±0,2	3,5	0,76	E/809032/***/X2
40	35	16	9	55	72	147,6	72,5	55	52,5	M5	63	40	M6	11	38 ±0,5	max.37	3,5	1,20	E/809040/***/X1
40	35	16	9	55	72	147,6	72,5	55	52,5	M5	75	60	M6	11	38 ±0,5	30 ±0,2	3,5	1,15	E/809040/***/X2
50	40	16	14	65,5	72	174	92,5	67	57	M5	75	60	M8	14	46,5 ±0,6	max. 36	3,5	1,73	E/809050/***/X1
63	45	16	14	74,5	89	193	95	76	57	M5	75	60	M8	15	56,5 ±0,7	max. 42	3,5	2,10	E/809063/***/X1
63	45	16	14	74,5	89	193	95	76	57	M6	100	80	M8	15	56,5 ±0,7	max. 42	3,5	2,20	E/809063/***/X2
80	45	17	14	95	95	225,5	116	-	63	M5	75	60	M10	16	72 ±0,7	max. 43	3,5	3,20	E/809080/***/X1
80	45	17	14	95	95	225,5	116	-	63	M6	100	80	M10	16	72 ±0,7	max. 43	3,5	3,25	E/809080/***/X2
100	55	17	19	113	125	279	144	120	68	M6	100	80	M10	19	89 ±0,7	max. 51	3,5	5,20	E/809100/***/X1
100	55	17	19	113	125	279	144	120	68	M8	130	110	M10	19	89 ±0,7	max. 51	3,5	5,64	E/809100/***/X2

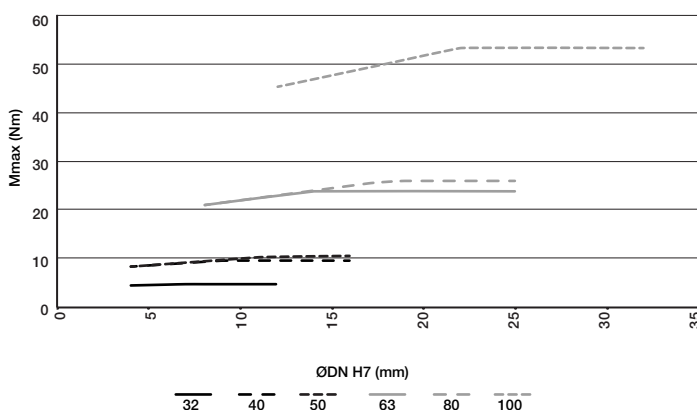
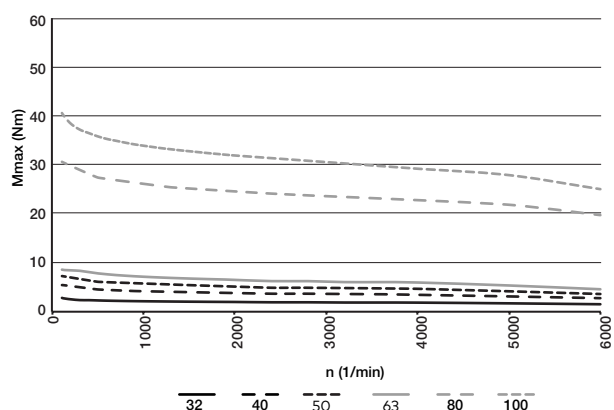
Coupling Graph

Toothbelt graph

Basic dimensions
E/809000/G**
Actuator variant with piston rod bellows

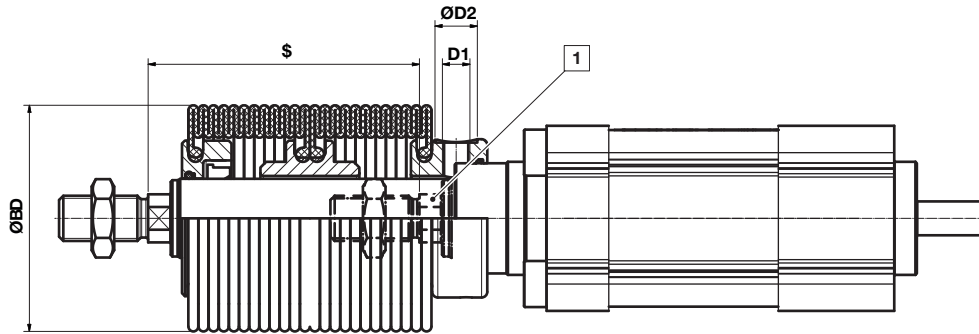
Dimensions in mm
 Projection/First angle











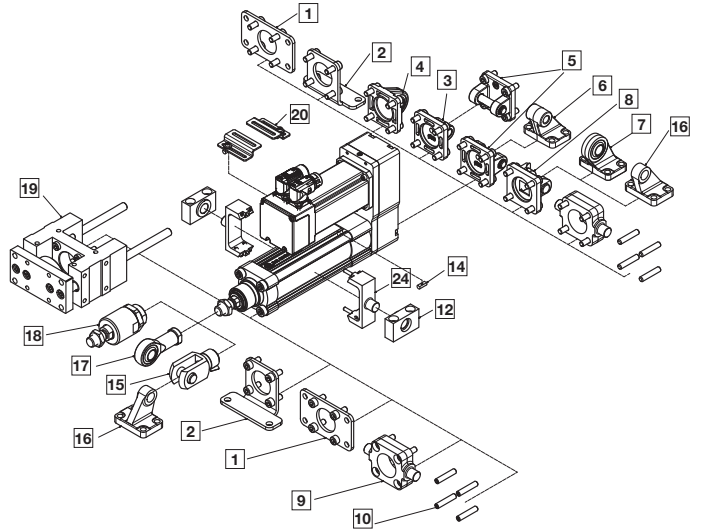
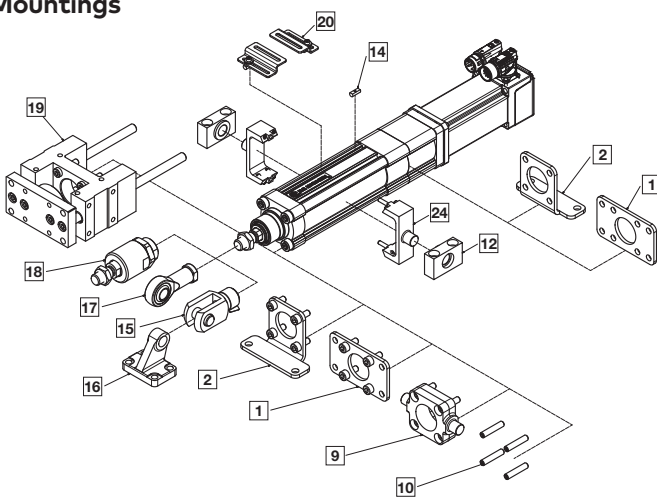

\$ = piston rod extension

1 Piston rod without bellows

Ø	ØBD	D1	ØD2	Piston rod ext. 1. bellows	Piston rod ext. further bellows	Max. stroke per bellows	Weight first bellow (kg)	Weight for further bellows (kg)	Typ
32	63	M5	9	40	32	145	0,13	0,08	E/809032/**G/AXX
40	80	G 1/8	15	52	43	250	0,29	0,22	E/809040/**G/AXX
50	80	G 1/8	15	53	43	250	0,29	0,21	E/809050/**G/AXX
63	80	G 1/8	15	53	43	250	0,30	0,18	E/809063/**G/AXX
80	116	G 1/4	19	69	60	350	0,71	0,50	E/809080/**G/AXX
100	116	G 1/4	19	69	60	350	0,73	0,43	E/809100/**G/AXX

Mountings



Model	A	AK	B, G	C	D	D2
						
	10	18	1	2	5	8
	Page 23	Page 23	Page 23	Page 24	Page 24	Page 24
Ø	32 QM/8032/35	QM/8025/38	QE/809032/22	QE/809032/21	QA/8032/23	QA/8032/42
	40 QM/8032/35	QM/8040/38	QE/809040/22	QE/809040/21	QA/8040/23	QA/8040/42
	50 QM/8050/35	QM/8050/38	QE/809050/22	QE/809050/21	QA/8050/23	QA/8050/42
	63 QM/8050/35	QM/8050/38	QE/809063/22	QE/809063/21	QA/8063/23	QA/8063/42
	80 QM/8080/35	QM/8080/38	QE/809080/22	QE/809080/21	QA/8080/23	QA/8080/42
	100 QM/8080/35	QM/8080/38	QE/809100/22	QE/809100/21	QA/8100/23	QA/8100/42
Model	F	FH	UH	S	SW	UF
						
	15	9	24	12	6	17
	Page 25	Page 25	Page 25	Page 26	Page 27	Page 26
Ø	32 QM/8025/25	QA/8032/34	PQA/802032/40	QA/8032/41	M/P19493	QM/8025/32
	40 QM/8040/25	QA/8040/34	PQA/802040/40	QA/8040/41	M/P19494	QM/8040/32
	50 QM/8050/25	QA/8050/34	PQA/802050/40	QA/8040/41	M/P19495	QM/8050/32
	63 QM/8050/25	QA/8063/34	PQA/802063/40	QA/8063/41	M/P19496	QM/8050/32
	80 QM/8080/25	–	PQA/802080/40	QA/8063/41	M/P19497	QM/8080/32
	100 QM/8080/25	–	PQA/802100/40	QA/8100/41	M/P19498	QM/8080/32
Model	UR	R	SS	US	Nutstein	Flanschplatte:
						
	4	3	16	7	14	20
	Page 26	Page 27	Page 27	Page 28	Page 28	Page 28
Ø	32 QA/8032/33	QA/8032/27	M/P19931	M/P40310	M/P72816	–
	40 QA/8040/33	QA/8040/27	M/P19932	M/P40311	M/P72816	–
	50 QA/8050/33	QA/8050/27	M/P19933	M/P40312	M/P72816	QA/802050/22/54
	63 QA/8063/33	QA/8063/27	M/P19934	M/P40313	M/P72816	QA/802050/22/54
	80 QA/8080/33	QA/8080/27	M/P19935	M/P40314	M/P72816	QA/802080/22/54
	100 QA/8100/33	QA/8100/27	M/P19936	M/P40315	M/P72816	QA/802080/22/54

Pos.	Style	Standard
1	B, G	Galvanised steel
2	C	Galvanised steel
3	R	Die-cast aluminium
4	UR	Die-cast aluminium Inner ring: steel, Outer ring: brass
5	D	Die-cast aluminium Bolt: Galvanised steel (martensitic) Circlip: Galvanised steel
6	SW	Die-cast aluminium
7	US	Painted cast iron Inner ring: steel, Outer ring: brass

Pos.	Style	Standard
8	D2	Die-cast aluminium Bolt: stainless steel (martensitic), Circlip: Galvanised steel
9	FH	Painted cast iron
10	A	Galvanised steel
12	S	Anodised aluminium Bearing: brass
14	Groove key	Steel
15	F	Galvanised steel, Bolt: galvanised steel, Circlip: Galvanised steel
16	SS	Painted cast iron

Pos.	Style	Standard
17	UF	Galvanised steel, Inner ring: steel, Outer ring: brass
18	AK	Galvanised steel
19	51, 61, 81, 85	Anodised aluminium
24	UH	Anodised aluminium

Guide blocks

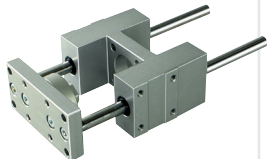
Model	Guide blocks - plain bearings
	
19	
Page 29	
Ø	
32	QA/8032/51/*
40	QA/8040/51/*
50	QA/8050/51/*
63	QA/8063/51/*

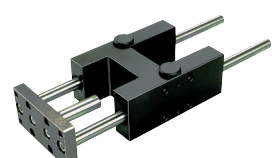
Model	Guide blocks - roller bearings
	
19	
Page 30	
Ø	
32	QA/8032/61/*
40	QA/8040/61/*
50	QA/8050/61/*
63	QA/8063/61/*

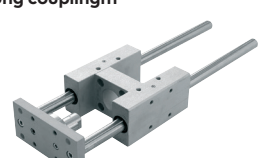
Model	Guide blocks - plain bearings, long couplingm
	
19	
Page 32	
Ø	
32	QA/8032/81/*
40	QA/8040/81/*
50	QA/8050/81/*
63	QA/8063/81/*

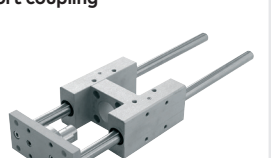
Model	Guide blocks - plain bearings, short coupling
	
19	
Page 32	
Ø	
32	QA/8032/85/*
40	QA/8040/85/*
50	QA/8050/85/*
63	QA/8063/85/*

Magnetically operated switches

Model	M/50/**
	
Page 40	
Ø	
32	
40	
50	
63	
80	
100	

Model	Groove cover
	
Page 28	
Ø	
32	M/P72725/1000
40	M/P72725/1000
50	M/P72725/1000
63	M/P72725/1000
80	M/P72725/1000
100	M/P72725/1000

Model	QE/M*
	
Page 34	
□	
50 (1,05 Nm)	QE/M05530/**
67 (2,45 Nm)	QE/M06730/**
67 (3,50 Nm)	QE/M06730/**
89 (6,90 Nm)	QE/M08930/**
115 (10,50 Nm)	QE/M11530/**

Mountings

Front or rear stud mounting A

Dimensions in mm
Projection/First angle

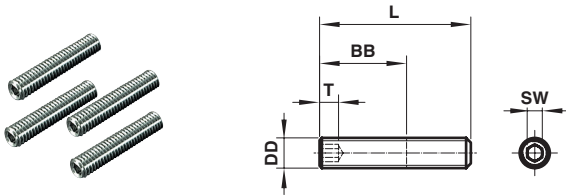

Ø	BB	DD	L	SW	T _{min}	(kg)	Model (A)
32/40	17	M6	30	3	3,5	0,02	QM/8032/35
50/63	23	M8	40	4	5	0,05	QM/8050/35
80/100	28	M10	45	5	6	0,08	QM/8080/35

Piston rod swivel

AK

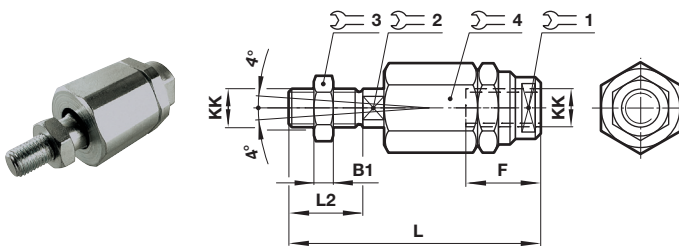

Ø	KK	B1	F	L	L2	SW				(kg)	F _{max} (N)	Model (AK)
						1	2	3	4			
32	M10 x 1,25	5	26	73	20	19	12	17	30	0,20	1.600	QM/8025/38
40	M12 x 1,25	6	26	77	24	19	12	19	30	0,20	2.500	QM/8040/38
50/63	M16 x 1,5	8	34	106	32	30	19	24	42	0,65	6.200	QM/8050/38
80/100	M20 x 1,5	10	42	122	40	30	19	30	42	0,72	15.700	QM/8080/38

Front flange B, G

Based on ISO 15552, type MF1 and MF2

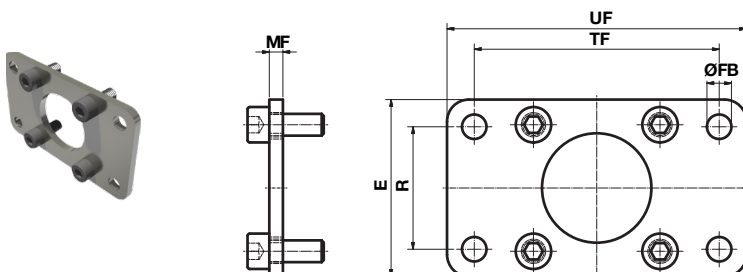

Ø	E	ØFB	MF	R	TF	UF	(kg)	F _{max} (N)	Model (B, G)
32	50	7	4	32	64	80	0,24	1.600	QE/809032/22
40	55	9	4	36	72	90	0,28	2.500	QE/809040/22
50	65	9	5	45	90	110	0,54	3.900	QE/809050/22
63	75	9	5	50	100	125	0,66	6.200	QE/809063/22
80	100	12	6	63	126	154	1,3	10.000	QE/809080/22
100	120	14	6	75	150	186	1,82	15.700	QE/809100/22

Foot mounting C

Based on ISO 15552, type MS1

Dimensions in mm
Projection/First angle

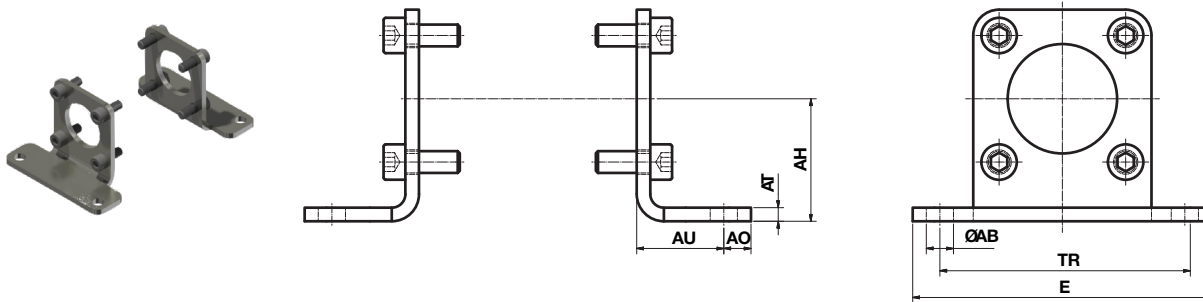

Ø	ØAB	AH	AO	AT	AU	E	TR	(kg)	F _{max} (N)	Model (C)
32	7	32	8	4	24	80	64	0,14	1.600	QE/809032/21
40	10	36	9	4	28	90	72	0,18	2.500	QE/809040/21
50	10	45	10	5	32	110	90	0,27	3.900	QE/809050/21
63	10	50	12	5	32	125	100	0,39	6.200	QE/809063/21
80	12	63	19	6	41	154	126	0,78	10.000	QE/809080/21
100	14,5	71	19	6	41	186	150	0,97	15.700	QE/809100/21

Rear clevis D

Conforms to ISO 15552, type MP2

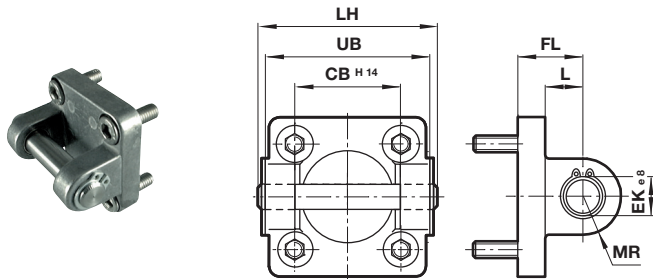

Ø	CB H14	ØEK e8	FL	L	LH	MR	UB	(kg)	F _{max} (N)	Model (D)
32	26	10	22	13	52	9	45	0,11	1.600	QA/8032/23
40	28	12	25	16	60	12	52	0,16	2.500	QA/8040/23
50	32	12	27	17	68	12	60	0,22	3.900	QA/8050/23
63	40	16	32	22	79	15	70	0,34	6.200	QA/8063/23
80	50	16	36	22	99	15	90	0,54	10.000	QA/8080/23
100	60	20	41	27	119	20	110	0,90	15.700	QA/8100/23

Rear clevis D2

Conforms to ISO 15552, type AB6

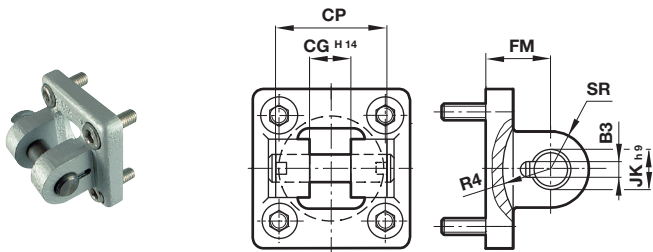

Ø	CG H14	CP	B3	ØJK h9	FM	SR	R4	(kg)	F _{max} (N)	Model (D2)
32	14	34	3,3	10	22	11	17	0,20	1.600	QA/8032/42
40	16	40	4,3	12	25	12	20	0,23	2.500	QA/8040/42
50	21	45	4,3	16	27	14,5	22	0,36	3.900	QA/8050/42
63	21	51	4,3	16	32	18	25	0,55	6.200	QA/8063/42
80	25	65	4,3	20	36	22	30	0,90	10.000	QA/8080/42
100	25	75	4,3	20	41	22	32	1,45	15.700	QA/8100/42

Piston rod clevis F

Conforms to DIN ISO 8140

Dimensions in mm
Projection/First angle

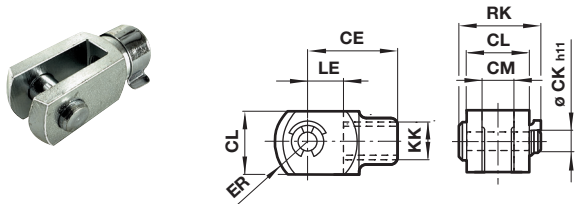

Ø	KK	CE	ØCK h11	CL	CM	ER	LE	RK	(kg)	F _{max} (N)	Model (F)
32	M10 x 1,25	40	10	20	10	16	20	27,5	0,09	1.600	QM/8025/25
40	M12 x 1,25	48	12	24	12	19	24	33,5	0,13	2.500	QM/8040/25
50/63	M16 x 1,5	64	16	32	16	25	32	42	0,33	6.200	QM/8050/25
80/100	M20 x 1,5	80	20	40	20	32	40	51	0,67	15.700	QM/8080/25

Front or rear detachable trunnion FH

Conforms to VDMA 24562 part 2, type MT 5/6

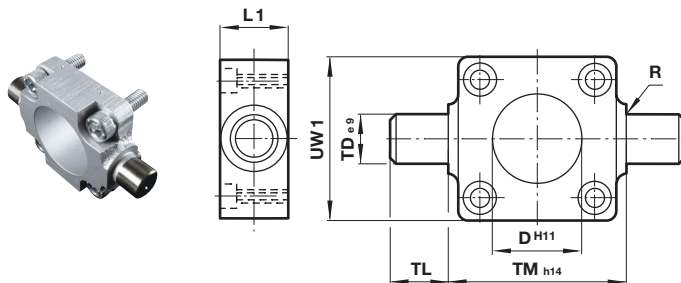

Ø	ØD H11	L1	R	ØTD e9	TL	TM h14	UW1	(kg)	F _{max} (N)	Model (FH)
32	30	16	1	12	12	50	45	0,20	1.600	QA/8032/34
40	35	20	1,6	16	16	63	55	0,38	2.500	QA/8040/34
50	40	24	1,6	16	16	75	65	0,60	3.900	QA/8050/34
63	45	24	1,6	20	20	90	75	1,10	6.200	QA/8063/34

Adjustable trunnion mounting UH

Conforms to ISO 15552, type MT4

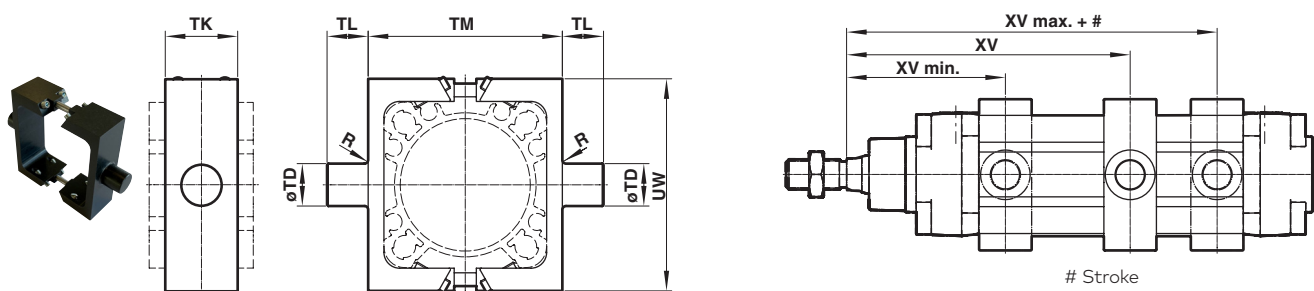

Ø	R	ØTD e9	TK max.	TL h14	TM h14	UW	XV min	XV max + #	(kg)	Torque (Nm)	F _{max} (N)	Model (UH)
32	1	12	25	12	50	58	65,5	88,5	0,06	0,8	1.600	PQA/802032/40
40	1,6	16	28	16	63	65	71	109,5	0,11	0,8	2.500	PQA/802040/40
50	1,6	16	28	16	75	80	81	113	0,16	3,0	3.900	PQA/802050/40
63	1,6	20	36	20	90	96	85	130	0,32	3,0	6.200	PQA/802063/40
80	1,6	20	36	20	110	116	98	162	0,37	4,0	10.000	PQA/802080/40
100	2	25	48	25	132	140	116	184	0,72	12,0	15.700	PQA/802100/40

Note: Mounting Type "UH" generally, this mount will not be pre-assembled and will be delivered separately with the actuator. The mount has to be mounted and adjusted to the needs of the application. It has to be secured with at least the above given torque.

If a pre-assembly should be done by Norgren, the dimension "XV" from the piston rod shoulder to the centre of the trunnion needs to be specified. Please be aware, that this dimension is taken with a completely instroke piston rod without considering any safety stroke.

Trunnion support S

Conforms to ISO 15552, type AT4

Dimensions in mm
Projection/First angle

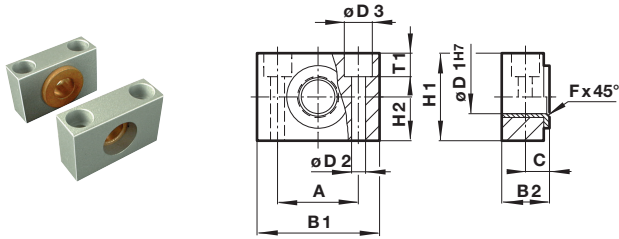

Ø	A	B1	B2	C	ØD1 H7	ØD2	ØD3	F x 45°	H1	H2	T1	(kg)	Model (S)
32	32	46	18	10,5	12	6,6	11	1	30	15	6,8	0,10	QA/8032/41
40/50	36	55	21	12	16	9	15	1,6	36	18	9	0,14	QA/8040/41
63/80	42	65	23	13	20	11	18	1,6	40	20	11	0,18	QA/8063/41
100	50	75	28,5	16,5	25	14	20	2	50	25	13	0,34	QA/8100/41

Universal piston rod eye UF

Conforms to DIN ISO 8139

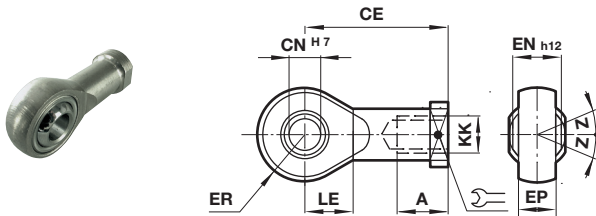

Ø	KK	A	CE	ØCN H7	EN h12	ER	LE	Z	(kg)	F _{max} (N)	Model (UF)
32	M10 x 1,25	20	43	10	14	14	15	9°	0,09	1.600	QM/8025/32
40	M12 x 1,25	22	50	12	16	16	17	13°	0,13	2.500	QM/8040/32
50/63	M16 x 1,5	28	64	16	21	21	22	15°	0,33	6.200	QM/8050/32
80/100	M20 x 1,5	33	77	20	25	25	26	15°	0,67	15.700	QM/8080/32

Universal rear eye UR

Conforms to ISO 15552, type MP6

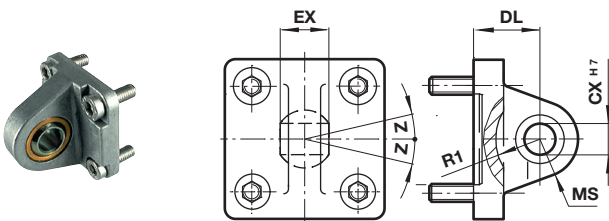

Ø	ØCX H7	EX	MS	DL	R1	Z	(kg)	F _{max} (N)	Model (UR)
32	10	14	16	22	13	13°	0,15	1.600	QA/8032/33
40	12	16	18	25	16	13°	0,25	2.500	QA/8040/33
50	16	21	21	27	19	15°	0,40	3.900	QA/8050/33
63	16	21	23	32	22	15°	0,55	6.200	QA/8063/33
80	20	25	28	36	24	14°	0,90	10.000	QA/8080/33
100	20	25	30	41	27	14°	1,50	15.700	QA/8100/33

Rear eye R

Conforms to ISO 15552, type MP4

Dimensions in mm
Projection/First angle

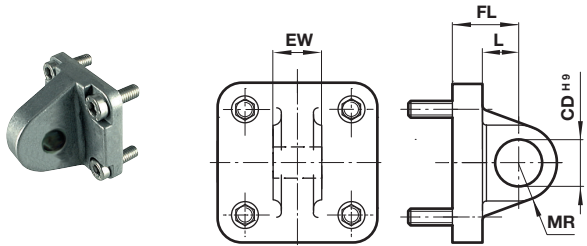

Ø	ØCD H9	EW	FL	L	MR	(kg)	F _{max} (N)	Model (R)
32	10	25,6	22	13	9	0,09	1.600	QA/8032/27
40	12	27,6	25	16	12	0,11	2.500	QA/8040/27
50	12	31,6	27	17	12	0,17	3.900	QA/8050/27
63	16	39,6	32	22	15	0,24	6.200	QA/8063/27
80	16	49,6	36	22	15	0,37	10.000	QA/8080/27
100	20	59,6	41	27	20	0,59	15.700	QA/8100/27

Wide hinge SW

Conforms to ISO 15552, type AB7

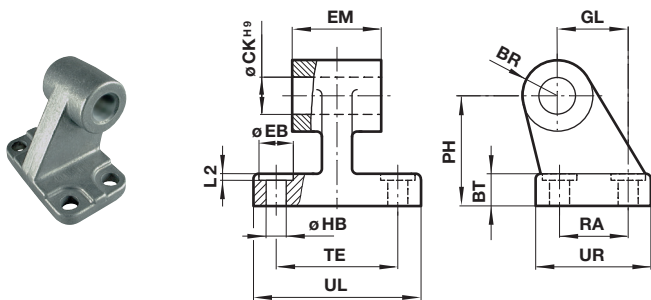

Ø	BR	BT	PH	ØCK H9	ØEB	EM	GL	ØHB	L2	RA	TE	UL	UR	(kg)	Model (SW)
32	10	7	32	10	12	25,6	21	6,6	1,6	18	38	50	31	0,05	M/P19493
40	11	9	36	12	12	27,6	24	6,6	1,6	22	41	53	35	0,07	M/P19494
50	13	11	45	12	15	31,6	33	9	1,6	30	50	65	45	0,14	M/P19495
63	15	11	50	16	15	39,6	37	9	1,6	35	52	67	50	0,18	M/P19496
80	15	14	63	16	18	49,6	47	11	2,5	40	66	84	60	0,28	M/P19497
100	18	15	71	20	18	59,6	55	11	2,5	50	76	94	70	0,42	M/P19748

Narrow hinge SS

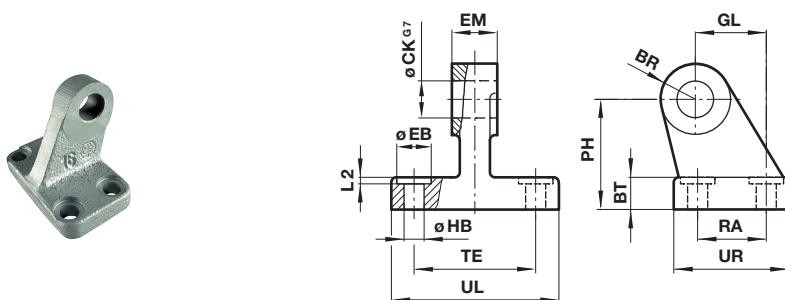

Ø	BR	BT	ØCK G7	ØEB	EM	GL	ØHB	L2	PH	RA	TE	UL	UR	(kg)	Model (SS)
32	10	8	10	11	10	21	6,6	1,6	32	18	38	51	31	0,15	M/P19931
40	11	10	12	11	12	24	6,6	1,6	36	22	41	54	35	0,20	M/P19932
50	13	12	16	15	16	33	9	1,6	45	30	50	65	45	0,48	M/P19933
63	15	12	16	15	16	37	9	1,6	50	35	52	67	50	0,50	M/P19934
80	15	14	20	18	20	47	11	2,5	63	40	66	86	60	0,75	M/P19935
100	19	15	20	18	20	55	11	2,5	71	50	76	96	70	1,20	M/P19936

Swivel hinge US
Conforms to VDMA 24562 part 2

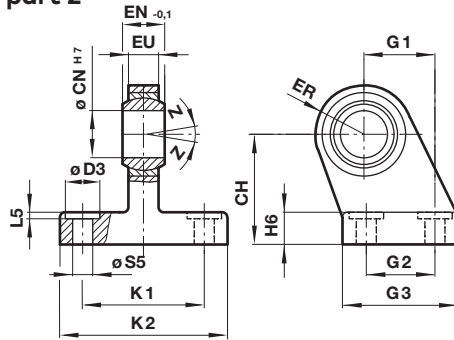
 Dimensions in mm
 Projection/First angle

Ø	CH	ØCN H7	ØD3	EN -0,1	ER	EU	G1	G2	G3	H6	K1	K2	L5	S5	Z	(kg)	Model (US)
32	32	10	11	14	16	10,5	21	18	31	10	38	51	1,6	6,6	13°	0,19	M/P40310
40	36	12	11	16	18	12	24	22	35	10	41	54	1,6	6,6	13°	0,24	M/P40311
50	45	16	15	21	21	15	33	30	45	12	50	65	1,6	9	15°	0,46	M/P40312
63	50	16	15	21	23	15	37	35	50	12	52	67	1,6	9	15°	0,59	M/P40313
80	63	20	18	25	28	18	47	40	60	14	66	86	2,5	11	14°	1,03	M/P40314
100	71	20	18	25	30	18	55	50	70	15	76	96	2,5	11	14°	1,40	M/P40315

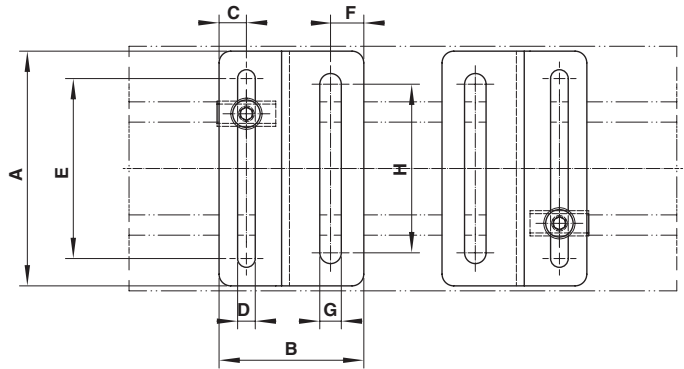
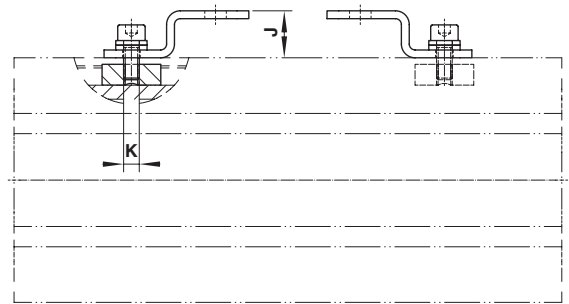
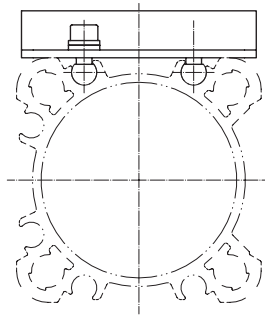
Mounting kit for profile barrel

Ø	A	B	C	D	E	F	G	H	J	K	SW	(kg)	Model
32/40	45	37	7	4,5	31	8,5	5,5	28,1	12	M4	3	0,06	PQA/802032/22/54
50/63	60	37	7	4,5	46	8,5	5,5	43	12	M4	3	0,08	PQA/802050/22/54
80/100	90	37	7	4,5	76	8,5	6,5	70	12	M4	3	0,11	PQA/802080/22/54

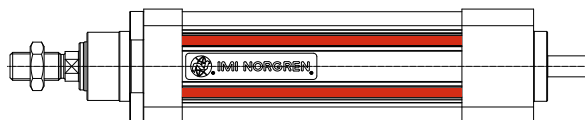
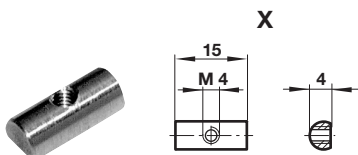
Groove key M/P72816
Weight: 0,01 (kg)
Groove cover M/P72725/1000

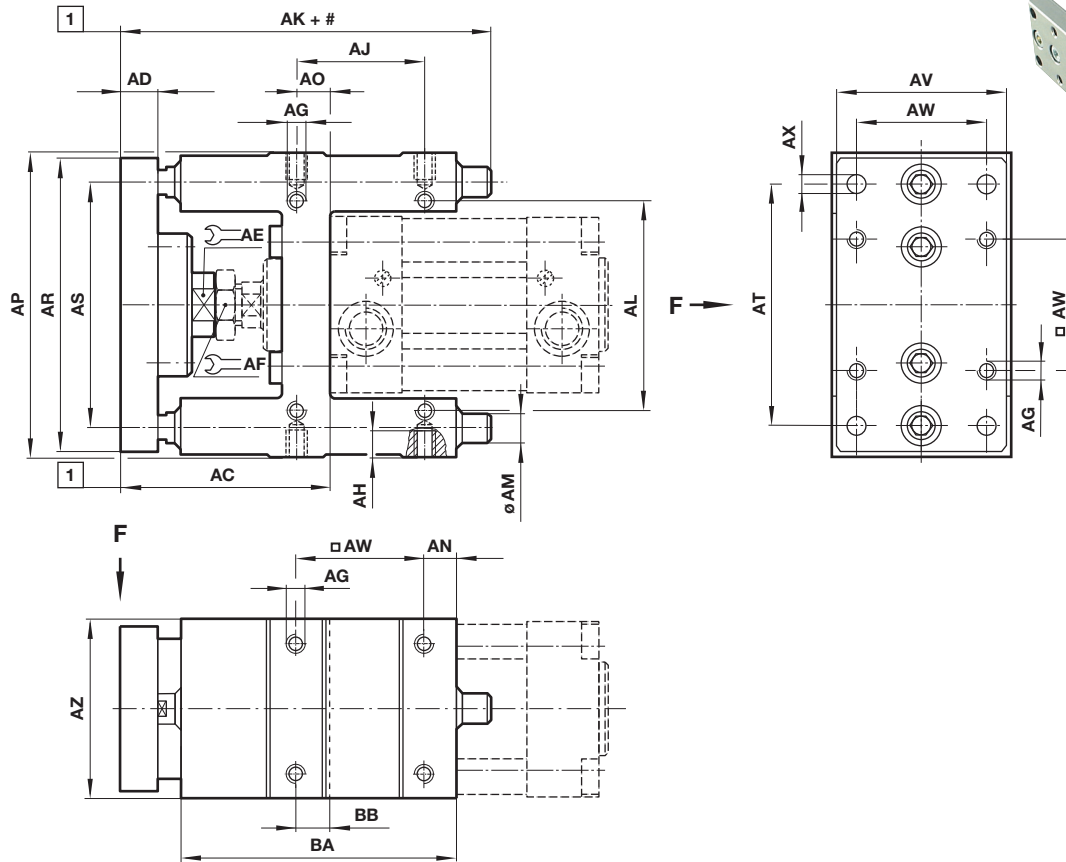
QA/8000/51 – Guide blocks (plain bearings)

Stroke
 1 Adjustment range
 Ø32 & 40 = +2
 Ø50 & 63 = +4

Ø	AC	AD	AE	AF	AG	AH	AJ	AK	AL	ØAM	AN	AO	AP
32	69	12	15	17	M6	10	32,5	110	58	10	6	9	100
40	74	12	15	19	M6	10	38	122	64	12	6	11	106
50	91,5	15	22	24	M8	12	46,5	135	80	12	6	19	125
63	92	15	22	24	M8	12	56,5	153	95	12	7	15	132

Ø	AR	AS	AT	AV	AW	ØAX	AZ	BA	BB	(kg) at 0 mm	(kg) per 100 mm	Model
32	90	74	78	45	32,5	6,6	48	76	9	1,0	0,06	QA/8032/51/*
40	100	80	84	50	38	6,6	56	85	11	1,2	0,09	QA/8040/51/*
50	120	96	100	60	46,5	9	66	99	19	1,8	0,09	QA/8050/51/*
63	125	104	105	70	56,5	9	76	114	15	2,2	0,09	QA/8063/51/*

* Insert standard stroke length: 50, 100, 160, 200, 250, 320, 400 and 500 mm, use nearest standard stroke.
 Note: Supplied complete with mounting screws for cylinders

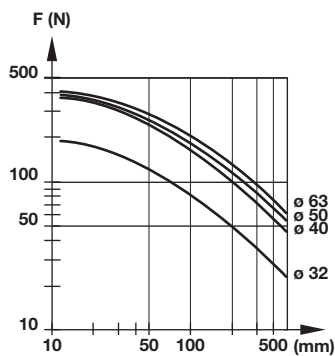
Maximum load

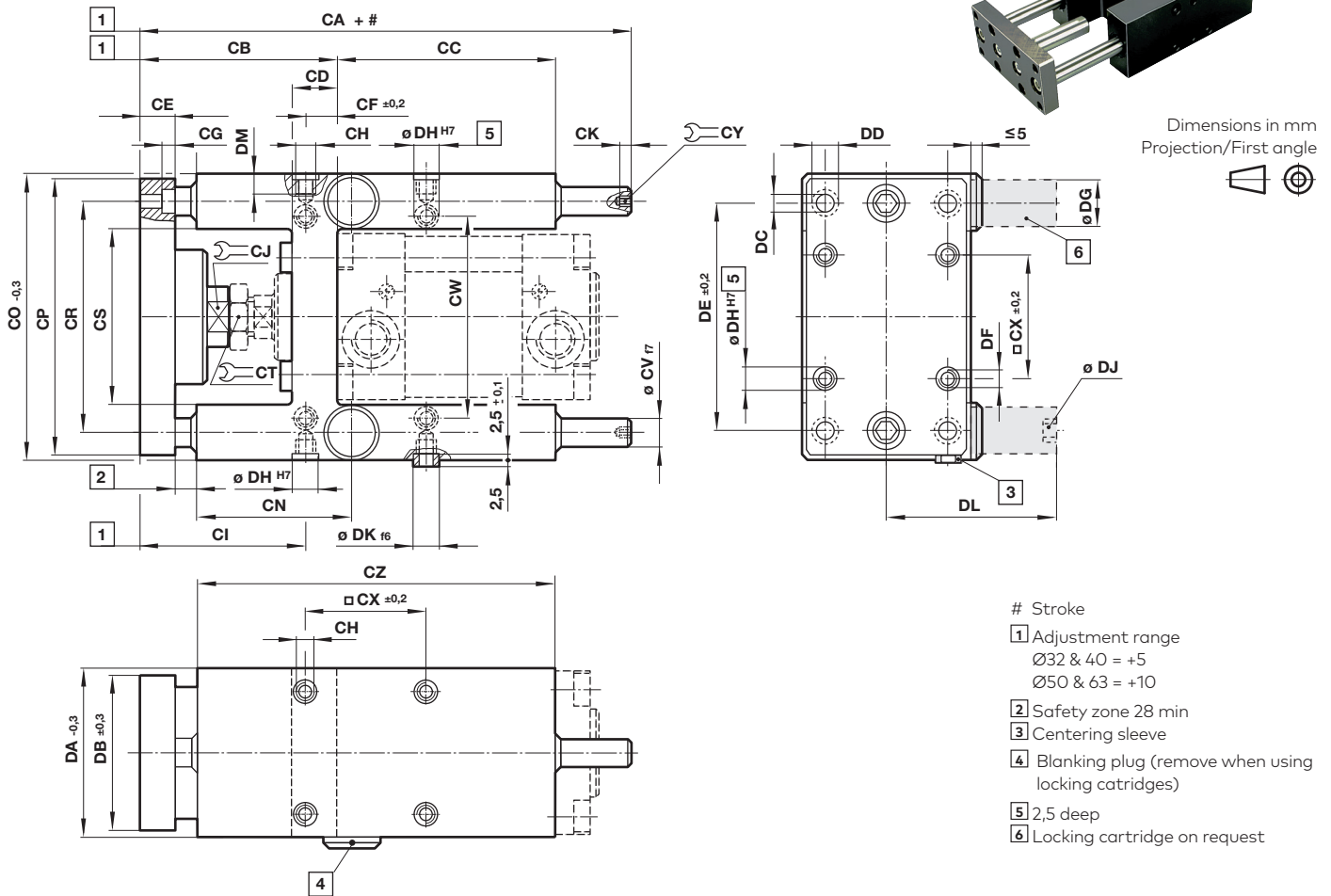
QA/8000/61 – Guide blocks (roller bearings)

Ø	CA	CB	CC	CD	CE	CF ±0,2	CG	CH	CI	CJ	CK	CN	CO -0,3
32	177	100	65	28	12	15,3	6,5	M 6	84,5	13	5	61	97
40	192	111	69	33	12	23	6,5	M 6	88	15	6	67	115
50	237	128	65	40	15	33,8	9	M 8	94	22	6	75,5	137
63	237	128	97	40	15	29,3	9	M 8	98,5	22	6	80	152

Ø	CP	CR	CS	CT	ØCV F7	CW	CX ±0,2	CY	CZ	DA -0,3	DB ±0,3	DC	ØDD
32	90	74	50,5	17	12	61	32,5	5	125	50	45	6,6	11
40	110	87	58,5	19	16	69	38	6	140	58	54	6,6	11
50	130	104	70,5	24	20	85	46,5	6	150	70	63	9	15
63	145	119	85,5	24	20	100	56,5	6	182	85	80	9	15

Ø	DE ±0,2	DF	ØDG	ØDH H7	DJ	ØDK f6	DL	DM	(kg) at 0 mm	(kg) per 100 mm	Locking force (N)	Cartridge *1)	Model
32	78	M 6	20	9	M 5	9	45	14	1,2	0,18	600	QA/8032/63	QA/8032/61/*
40	84	M 6	24	9	G1/8	9	61,5	14	2,2	0,32	1000	QA/8040/63	QA/8040/61/*
50	100	M 8	30	11	G1/8	11	76,5	16	3,6	0,49	1500	QA/8050/63	QA/8050/61/*
63	105	M 8	30	11	G1/8	11	76,5	16	4,6	0,49	1500	QA/8050/63	QA/8063/61/*

* Insert standard stroke length: 50, 100, 160, 200, 250, 320, 400 and 500 mm, use nearest standard stroke.

Note: Supplied complete with mounting screws for cylinders

*1) Locking cartridges should be ordered separately. Passive - pressure to unlock. Two required per guide block.

Maximum load for QA/8000/61

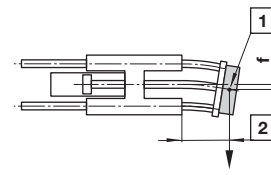
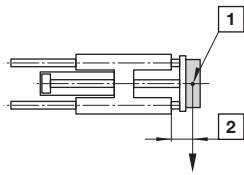

Dimensions in mm
Projection/First angle



- 1 Centre of gravity load capacity
- 2 Outstroke

Maximum load capacity is dependent on the outstroke of a horizontally installed guide unit. In the case of short stroke operation, the load capacity figures taken from the diagram must be multiplied by the correction factor (diagram 2). In the curves of load capacity (diagram 1), the short stroke corrections have already been taken into account for an outstroke > 60 mm.

The total deflection of guide rods will be determined by the addition of that due to own weight (diagram 3) and that due to load capacity (diagram 4).

Maximum load capacity depending on outstroke (diagram 1)

(diagram 2)

Deflection caused by own weight (diagram 3)

Deflection caused by a load of 10 N (diagram 4)

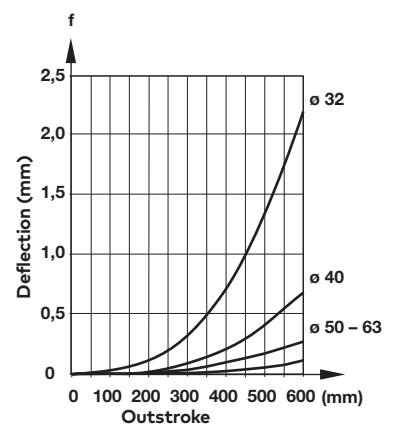
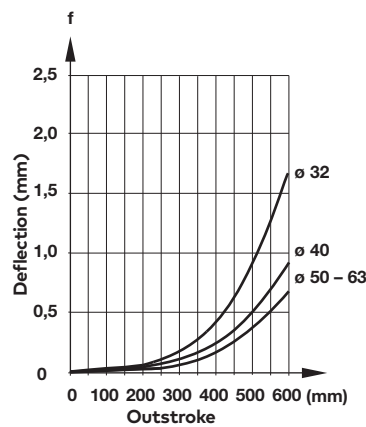
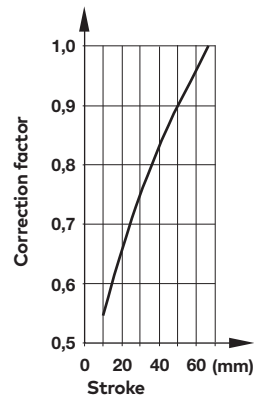
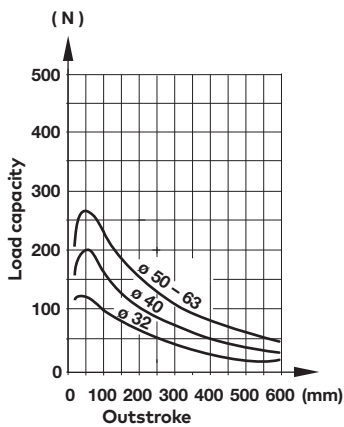

In the case of shock load applications, the figures given in the diagrams above must be reduced by a factor of 2.

QA/8000/81 – Guide blocks (long coupling)
 QA/8000/85 – Guide blocks (short coupling)

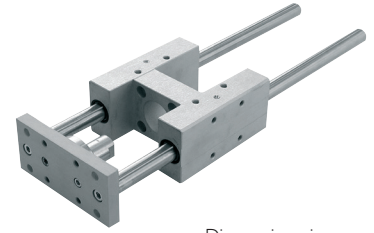
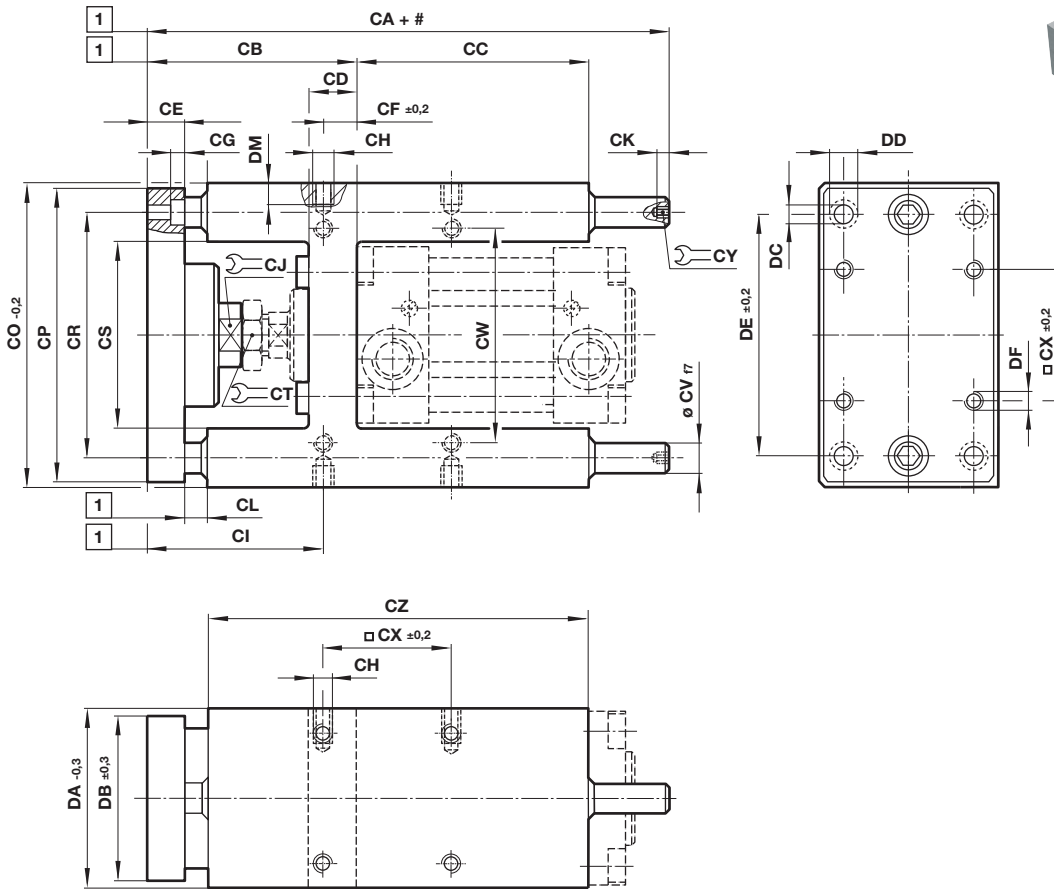

Dimensions in mm
 Projection/First angle



Stroke
 1 Adjustment range
 Ø32 & 40 = +5
 Ø50 & 63 = +10

Ø	CA /81	CA /85	CB + /81	CB + /85	CC	CD	CE	CF ±0,2	CG	CH	CI /81	CI /85	CS C J
32	174	149	89	64	75	24	12	4,3	6,5	M 6	84,7	59,7	15
40	189	164	99	74	80	28	12	11	6,5	M 6	88	63	15
50	210	181	113	88	78	34	15	18,8	8,5	M 8	94,2	69,2	20
63	235	210	114	89	106	34	15	15,3	9	M 8	98,7	73,7	20

Ø	CK	CL /81	CL /85	CO ±0,2	CP	CR	CS	CT	ØCV f8	CW	□CX ±0,2	CY	CZ
32	5	27	2	97	93	74	51	17	12	61	32,5	5	125
40	6	27	2	115	112	87	58,2	19	16	69	38	6	140
50	6	28	3	137	134	104	70,2	24	20	85	46,5	6	148
63	6	27	2	152	147	119	85,2	24	20	100	56,5	6	178

Ø	DA ±0,2	DB ±0,3	ØDC	ØDD	DE ±0,2	DF	DM	(kg) /81 at 0 mm	(kg) /85 at 0 mm	(kg) /81; /85 per 100 mm	Model /81	Model /85
32	49	45	6,6	11	78	M 6	12	1,2	1,15	0,18	QA/8032/81	QA/8032/85
40	58	55	6,6	11	84	M 6	12	2,2	2,15	0,32	QA/8040/81	QA/8040/85
50	70	65	9	15	100	M 8	16	3,6	3,55	0,49	QA/8050/81	QA/8050/85
63	85	80	9	15	105	M 8	16	4,6	4,55	0,49	QA/8063/81	QA/8063/85

* Insert standard stroke length: 50, 100, 160, 200, 250, 320, 400 and 500 mm, use nearest standard stroke.
 Note: Supplied complete with mounting screws for cylinders

Maximum load for QA/8000/81 and /85

Dimensions in mm
Projection/First angle

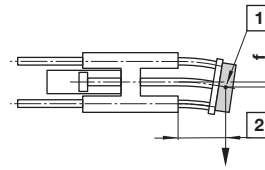
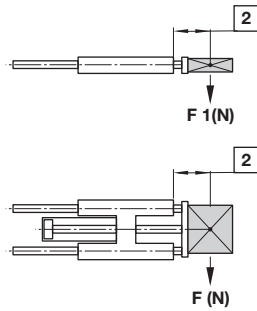

- 1 Centre of gravity load capacity
- 2 Outstroke

$F1 = F \times 0,9$
Static force: $F2 = F \times 2$

Max. load capacity (diagram 1) is dependent on the outstroke of a horizontally installed guide unit.

The total deflection of guide rods will be determined by the addition of the amount of deflection caused by own weight (according to diagram 2) plus the amount of deflection due to load capacity (according to diagram 3).

Maximum load capacity depending on outstroke (diagram 1)

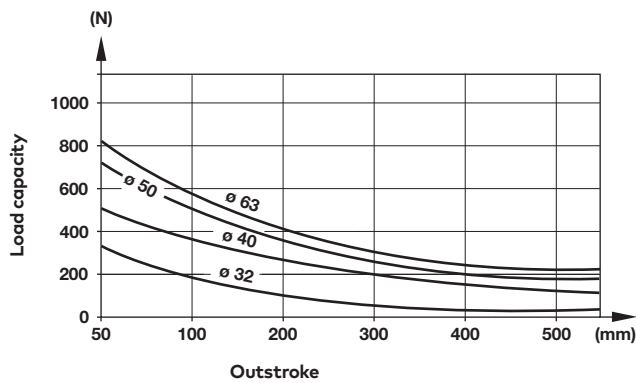

Deflection caused by own weight (diagram 2)

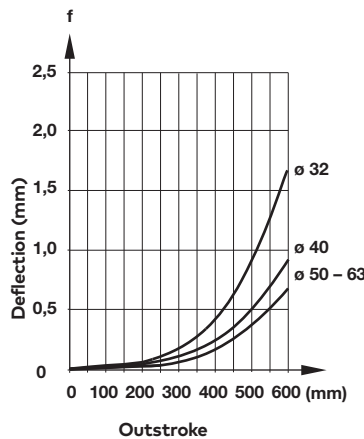

Deflection caused by a load of 10 N (diagram 3)

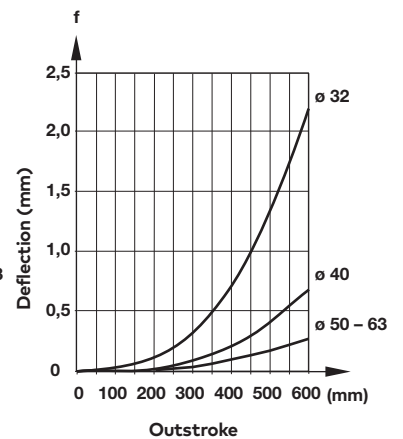

In the case of shock load applications, the figures given in the diagrams above must be reduced by a factor of 2

- > Compact servo motor with high dynamics
- > Patented rotor technology
- > Holding brake available
- > Very high torque is required during rapid acceleration and deceleration profiles
- > IP65
- > Rated torques from 1,05 Nm up to 10,5 Nm
- > Optimised for pulse-duty application (300% overload)
- > 400 V three-phase
- > Two different feedback systems (Resolver or Absolute (Multi turn))



Technical features

Voltage:

400 VAC

Rated current:

0,7 ... 9 A

Power:

0,16 ... 3,3 kW

Rated speed (rpm):

3000

Ambient temperature:

0 ... 40 °C (32 ... 104 °F)

Humidity:

0 ... 95%

IP Protection rate:

IP65

Plug in for motor cable

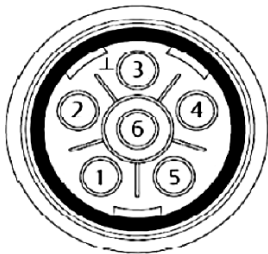

Plug in for feedback cable

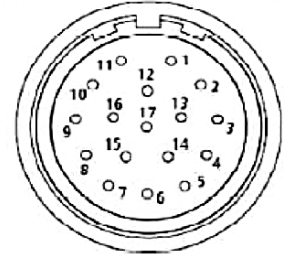
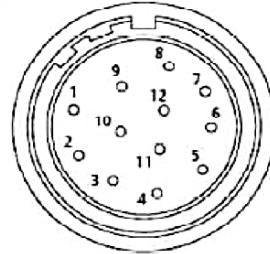

Pin	Function with holding brake	Function without holding brake
1	Phase U (R)	Phase U (R)
2	Phase V (S)	Phase V (S)
3	Ground	Ground
4	Phase W (T)	Phase W (T)
5	Brake +24 V	
6	Brake 0 V	
Shell	Screen	Screen

Pin	Function Resolver	Function Absolute (Multi turn)
1	Excitation High	Thermistor
2	Excitation Low	Thermistor
3	Cos High	Screen (Optical only)
4	Cos Low	
5	Sin High	
6	Sin Low	
7	Thermistor	
8	Thermistor	+ Clock
9		- Clock
10		
11		+ Data
12		- Data
13		- Cos
14		
15		
16		
17		0 Volts
Body	Screen	Screen

For further information please visit:

<http://acim.nidec.com/drives/control-techniques/downloads/user-guides-and-software/unimotorhd>

Motor QE/M05530/*

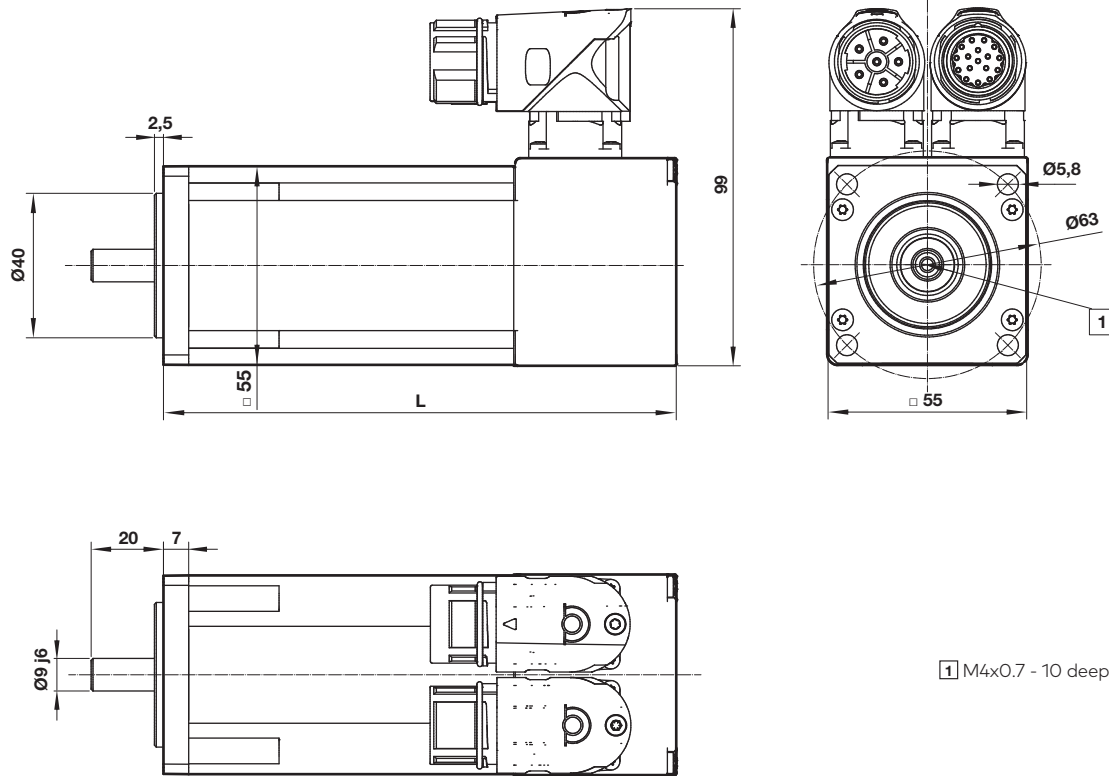
 Dimensions in mm
 Projection/First angle

Motor-code	Feedback system	Rated torque (Nm)	Rated power (kW)	Stall current (A)	Motor stall torque (Nm)	Motor peak torque (Nm)	Braking torque holding brake (Nm)	Inertia (kg m ²)	Brake	L (mm)	Weight (kg)	Nidec reference number	Model
EA	Resolver	1,05	0,33	0,79	1,18	4,72	-	0,000025	-	142	1,5	055UDB300BAARA063090	QE/M05530/EA/09
EB	Absolute (Multi turn)	1,05	0,33	0,79	1,18	4,72	-	0,000025	-	142	1,5	055UDB300BAEGA063090	QE/M05530/EB/09
EM	Resolver	1,05	0,33	0,79	1,18	4,72	1,8	0,000025	x	182	1,9	055UDB305BAARA063090	QE/M05530/EM/09
EN	Absolute (Multi turn)	1,05	0,33	0,79	1,18	4,72	1,8	0,000025	x	182	1,9	055UDB305BAEGA063090	QE/M05530/EN/09

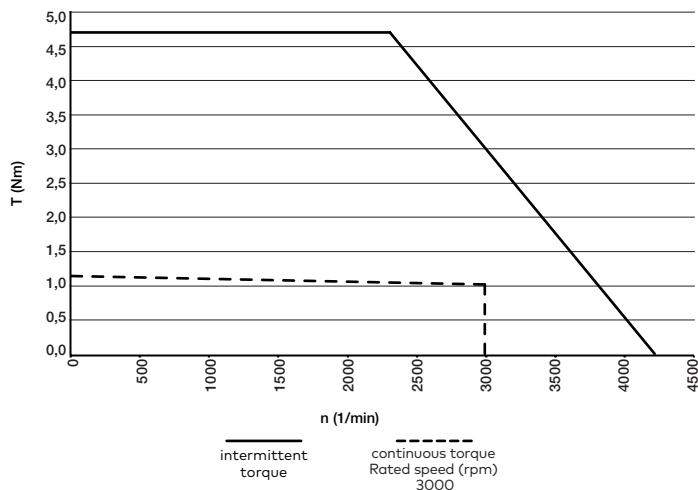
QE/M05530/E*

Motor QE/M06730/*

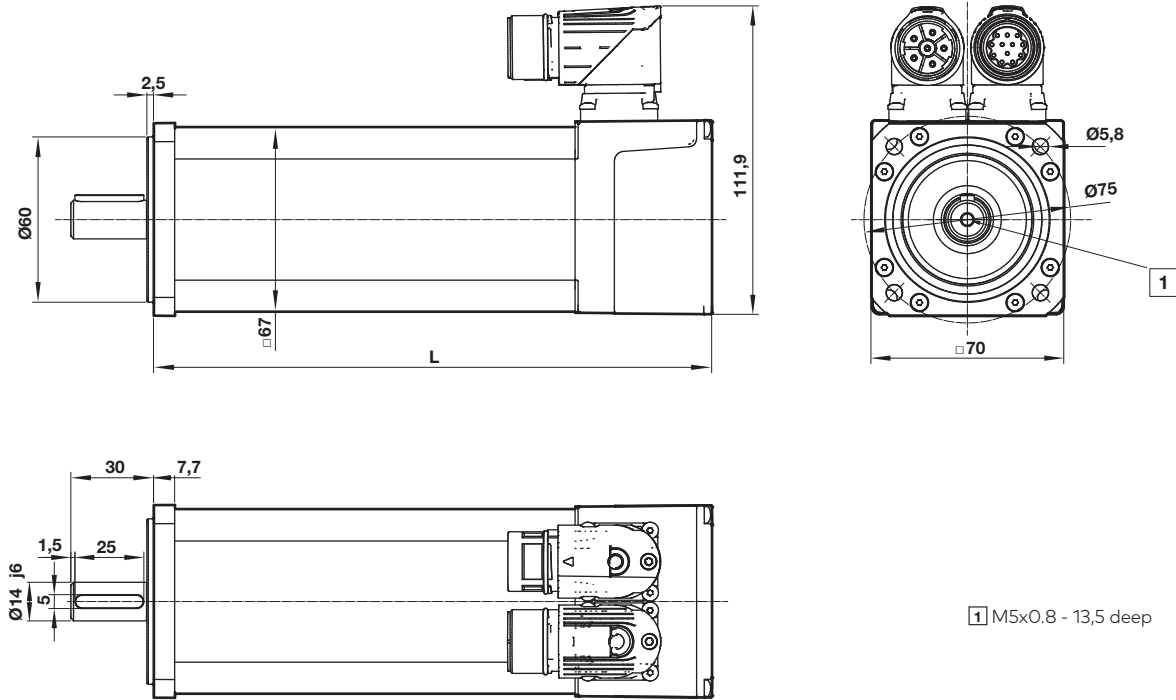
 Dimensions in mm
 Projection/First angle

1 M5x0.8 - 13,5 deep

Motor-code	Feedback system	Rated torque (Nm)	Rated power (kW)	Stall current (A)	Motor stall torque (Nm)	Motor peak torque (Nm)	Braking torque holding brake (Nm)	Inertia (kg m ²)	Brake	L (mm)	Weight (kg)	Nidec reference number	Model
JA	Resolver	2,45	0,77	1,59	2,55	7,65	-	0,000053	-	172,7	2,6	067UDB300BAARA	QE/M06730/JA/14
JB	Absolute (Multi turn)	2,45	0,77	1,59	2,55	7,65	-	0,000053	-	172,7	2,6	067UDB300BAEGA	QE/M06730/JB/14
JM	Resolver	2,45	0,77	1,59	2,55	7,65	2,0	0,000053	x	207,7	3,3	067UDB306BAARA	QE/M06730/JM/14
JN	Absolute (Multi turn)	2,45	0,77	1,59	2,55	7,65	2,0	0,000053	x	207,7	3,3	067UDB306BAEGA	QE/M06730/JN/14
NA	Resolver	3,50	1,10	2,31	3,70	11,10	-	0,000075	-	202,7	3,2	067UDC300BAARA	QE/M06730/NA/14
NB	Absolute (Multi turn)	3,50	1,10	2,31	3,70	11,10	-	0,000075	-	202,7	3,2	067UDC300BAEGA	QE/M06730/NB/14
NM	Resolver	3,50	1,10	2,31	3,70	11,10	2,0	0,000075	x	237,7	3,8	067UDC306BAARA	QE/M06730/NM/14
NN	Absolute (Multi turn)	3,50	1,10	2,31	3,70	11,10	2,0	0,000075	x	237,7	3,8	067UDC306BAEGA	QE/M06730/NN/14

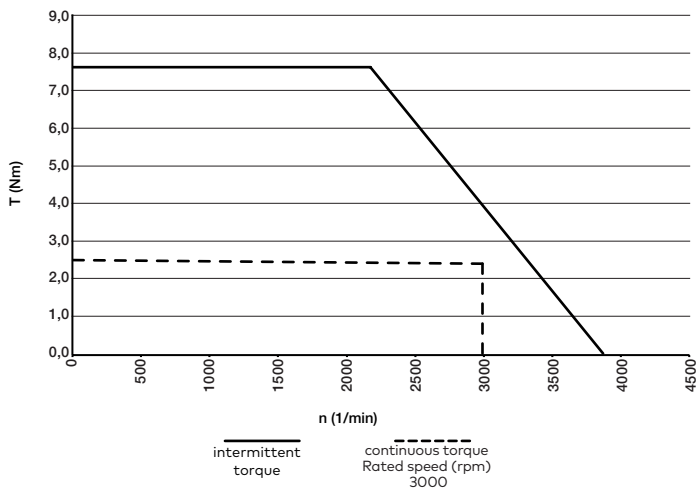
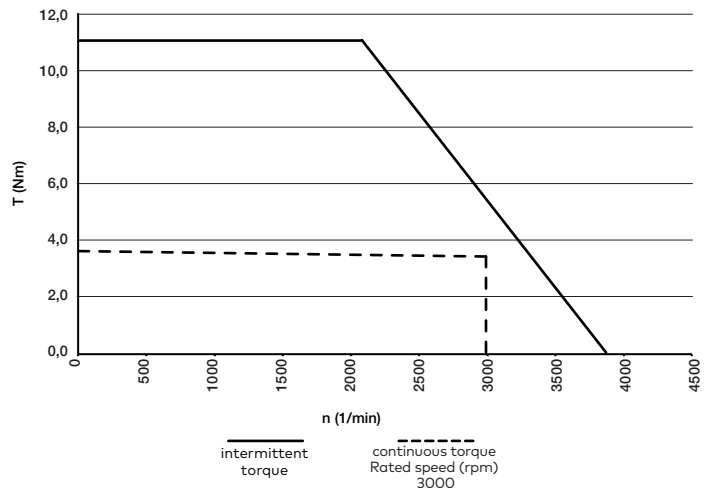
QE/M06730/J*

QE/M06730/N*

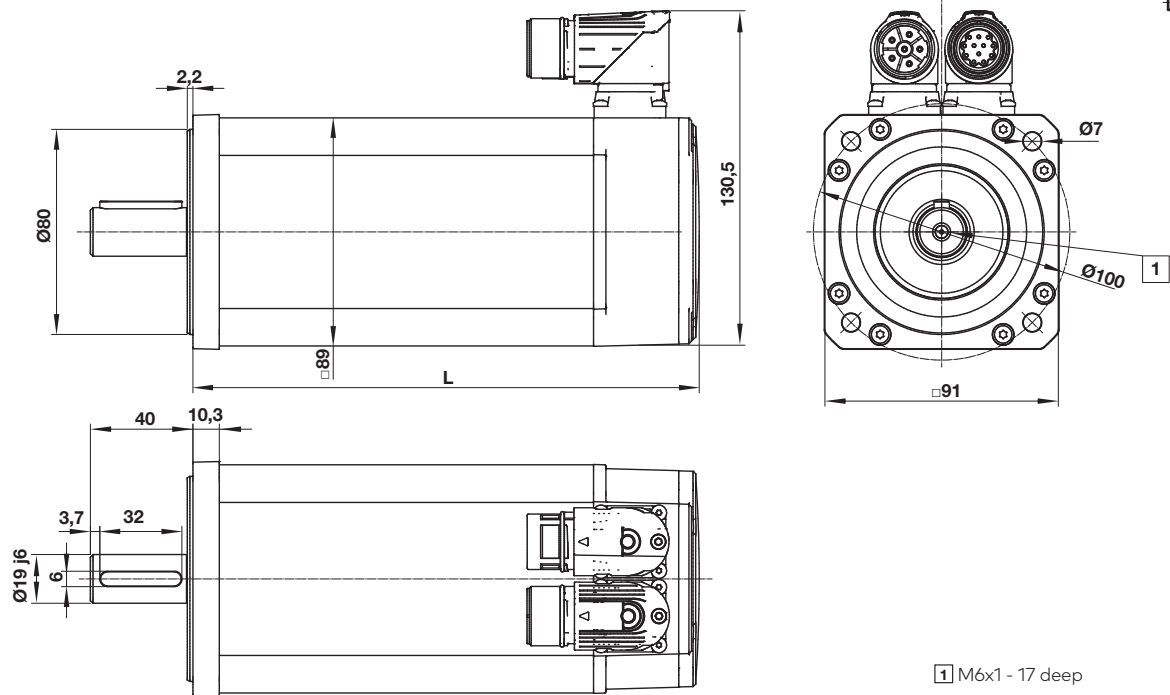
Motor QE/M08930/*

 Dimensions in mm
 Projection/First angle

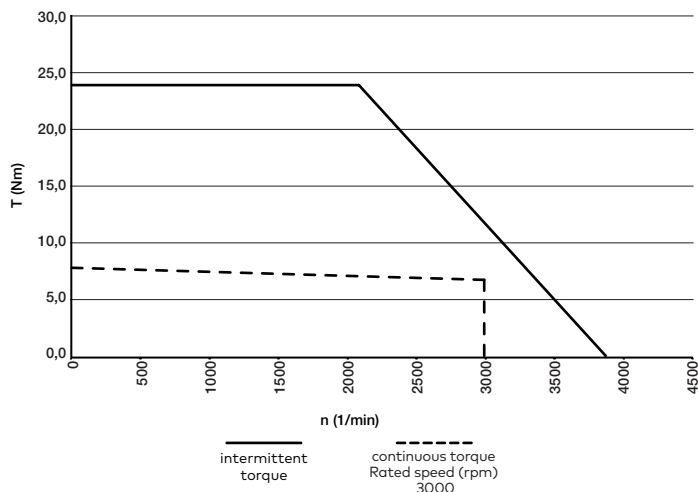
Motor-code	Feedback system	Rated torque (Nm)	Rated power (kW)	Stall current (A)	Motor stall torque (Nm)	Motor peak torque (Nm)	Braking torque holding brake (Nm)	Inertia (kg m ²)	Brake	L (mm)	Weight (kg)	Nidec reference number	Model
RA	Resolver	6,90	2,17	5,0	8,0	24,0	-	0,000234	-	197,8	5,5	089UDC300BAAEA	QE/M08930/RA/19
RB	Absolute (Multi turn)	6,90	2,17	5,0	8,0	24,0	-	0,000234	-	207,8	4,9	089UDC300BAECA	QE/M08930/RB/19
RM	Resolver	6,90	2,17	5,0	8,0	24,0	10,0	0,000234	x	237,9	6,8	089UDC306BAAEA	QE/M08930/RM/19
RN	Absolute (Multi turn)	6,90	2,17	5,0	8,0	24,0	10,0	0,000234	x	247,9	6,2	089UDC306BAECA	QE/M08930/RN/19

QE/M08930/R*

Motor QE/M11530/*

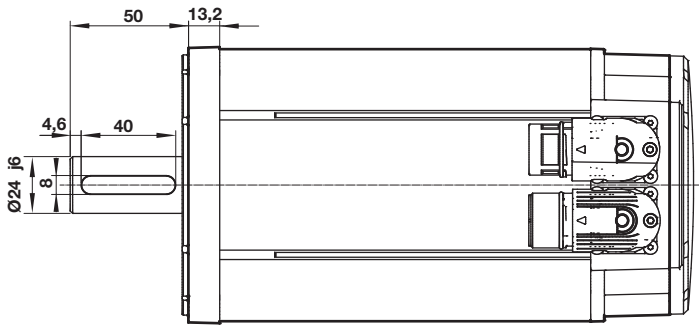
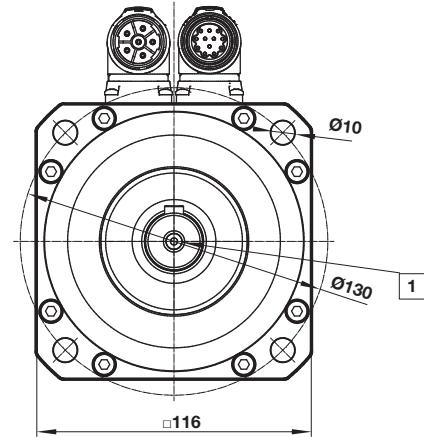
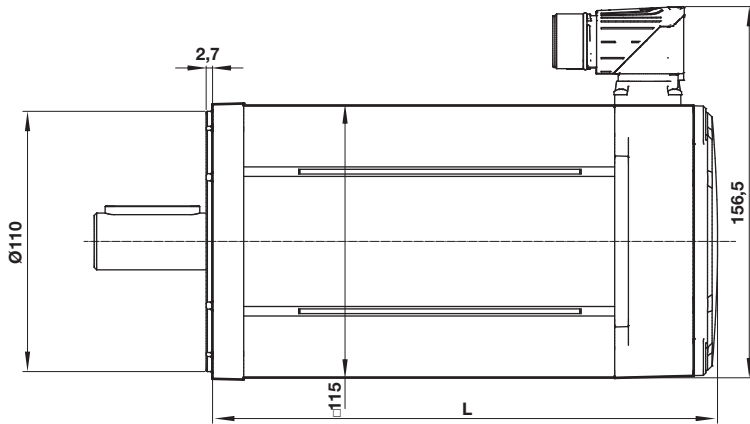
 Dimensions in mm
 Projection/First angle

1 M8x1.25 - 20 deep

Motor-code	Feedback system	Rated torque (Nm)	Rated power (kW)	Stall current (A)	Motor stall torque (Nm)	Motor peak torque (Nm)	Braking torque holding brake (Nm)	Inertia (kg m ²)	Brake	L (mm)	Weight (kg)	Nidec reference number	Model
WA	Resolver	10,50	3,3	9,13	14,6	43,8	-	0,000639	-	213,8	8,9	115UDC300BAAEA	QE/M11530/WA/24
WB	Absolute (Multi turn)	10,50	3,3	9,13	14,6	43,8	-	0,000639	-	223,8	8,2	115UDC300BAECA	QE/M11530/WB/24
WM	Resolver	10,50	3,3	9,13	14,6	43,8	16,0	0,000639	x	250,9	10,4	115UDC306BAAEA	QE/M11530/WM/24
WN	Absolute (Multi turn)	10,50	3,3	9,13	14,6	43,8	16,0	0,000639	x	260,9	9,7	115UDC306BAECA	QE/M11530/WN/24

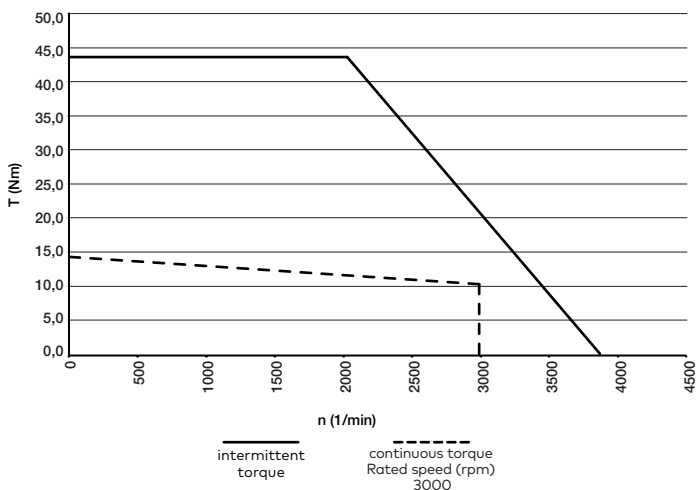
QE/M11530/W*

- > 2 Compact drive frame sizes with maximum performance
- > Onboard Advanced Motion Controller for distributed 1.5 axis motion control
- > Integrated Dual Safe Torque Off - "SIL3 and PLe"
- > Option module flexibility
- > Drives available with EtherCAT, PROFINET, PROFIBUS, EtherNet/IP, DeviceNet & CANopen communications
- > Built-in RS485 communications
- > SD Card slot

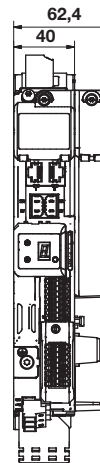
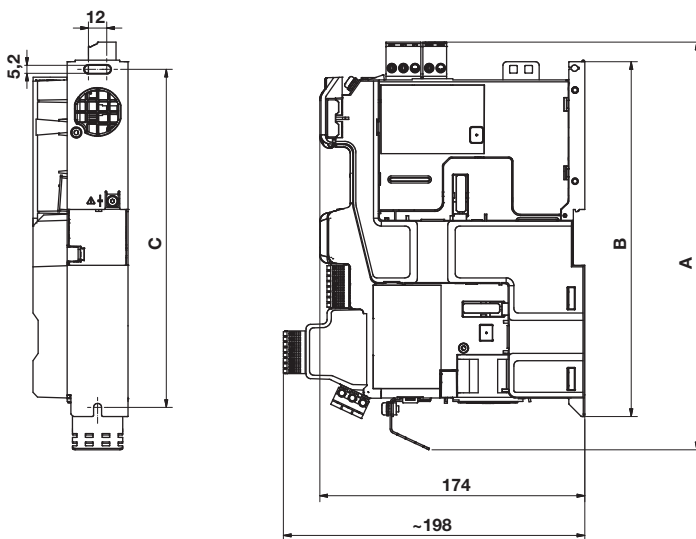

A	B	C	Nidec reference number	Standard model drive
~ 268	233	222	M751-01400030A10100AB110	QE/D01400030
~ 313	278	267	M751-02400105A10100AB110	QE/D02400105

Description	Line supply (VAC)	Voltage (V)	Output power (kW):	max. Power (kW)	Rated current (A)	max. Peak current (A)	max. output frequency (Hz)	Overload closed loop	Overload open loop	Nidec reference number	Standard model drive
Standard drive with internal Bus-system (for motor size □55 - 67)	three-phase 380 ... 480 (±10%) at 45 ... 66 Hz	400	0,75	6,5	3	9	599	300% for 0,25 s or 200% for 4 s	150% for 8 s	M751-01400030A10100AB110	QE/D01400030
Standard drive with internal Bus-system (for motor size □89 - 115)	three-phase 380 ... 480 (±10%) at 45 ... 66 Hz	400	4,0	8,7	10,5	31,5	599	300% for 0,25 s or 200% for 4 s	150% for 8 s	M751-02400105A10100AB110	QE/D02400105

For further information please visit:

<http://acim.nidec.com/drives/control-techniques/downloads/user-guides-and-software/digitax-hd>

- > Magnetically operated reed switch - Round style
- > Suitable for all cylinder ranges with magnetic piston
- > Switches can be mounted flush with the delivered special adaptor
- > LED indicator on LSU models
- > Alternative variants allow a wide range of application



Technical features

Operation:

M/50/LSU Normally open with LED (yellow)

Switching voltage (U_b):

10 ... 240 VAC/170 VDC

Switching voltage output:

U_b - 2,7 V

Switching current

(see graph overleaf):
0,18 A max.

Switching power:

10 W/10 VA max.

Contact resistance:

150 mΩ

Response time:

1,8 ms

Operating temperature:

-25 ... +80 °C (-13 ... +176 °F)

High temperature version:

+150 °C max.(+302 °F)

Protection rating (EN 60529):

IP66

Shock resistance:

50 g (during 11 ms)

Vibration resistance:

35 g (at 2000 Hz)

Cable type:

2 x 0,25: PVC, PUR or silicone

3 x 0,25 PVC

Cable length:

2, 5 or 10 m

Electromagnetic compatibility

according to:

EN 60947-5-2

Materials:

Body: plastic

Cable: see table below

Technical data - Reed switches - additional information see data sheet en 4.3.005

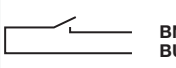
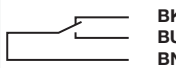
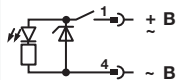
Symbol	Voltage (VAC)	Voltage (VDC)	Current maximum (mA)	Function	Operating temperature (°C)	LED	Protection class	Plug	Cable length (m)	Cable type	Weight (g)	Model
 ± BN ~ BU	10 ... 240	10 ... 170	180	Normally open	-25 ... +80	•	IP 66	—	2,5 or 10	PVC 2 x 0,25	37	M/50/LSU/*V
	10 ... 240	10 ... 170	180	Normally open	-25 ... +80	•	IP 66	—	5	PUR 2 x 0,25	37	M/50/LSU/5U
 BN BU	10 ... 240	10 ... 170	180	Normally open	-25 ... +150	—	IP 66	—	2	Silicon 2 x 0,25	37	TM/50/RAU/2S
 BK BU BN	10 ... 240	10 ... 170	180	Changeover	-25 ... +80	—	IP 66	—	5	PVC 3 x 0,25	37	M/50/RAC/5V
 ± BN ~ BK	10 ... 60	10 ... 60	180	Normally open	-25 ... +80	•	IP 66	M8 x 1	0,3	PVC 3 x 0,25	16	M/50/LSU/CP *1)
	10 ... 60	10 ... 60	180	Normally open	-25 ... +80	•	IP 66	M12 x 1	0,3	PVC 3 x 0,25	16	M/50/LSU/CC *1)

* Insert cable length; *1) Plug-in connector see page 41,

Dimensions

M/50/LSU/*V, M/50/LSU/5U,
TM/50/RAU/2S
Cable length L = 2, 5 or 10 m

Dimensions in mm
Projection/First angle

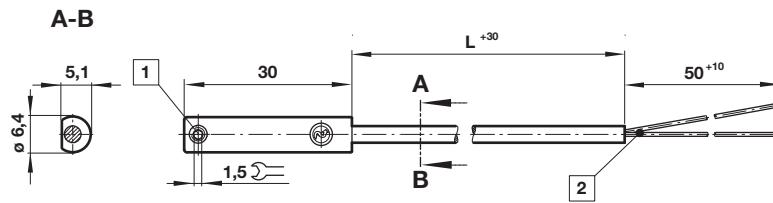

M/50/RAC/5V
Cable length L = 5 m

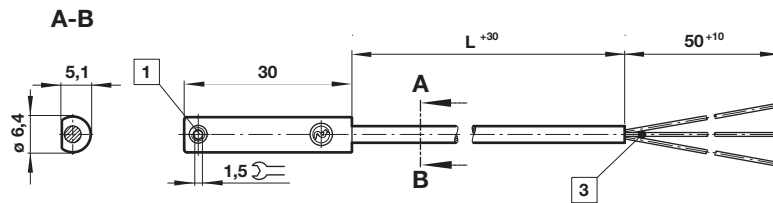

M/50/LSU/CP
M/50/LSU/CC

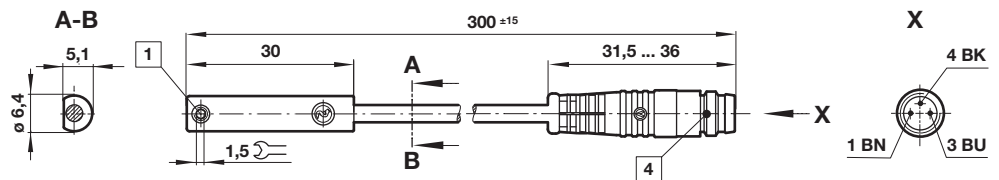

- 1 Fixing screw
- 2 + BN = brown; - BU = blue (output)
- 3 - BK = black; + BN = brown; - ≠BU = blue
- 4 Version CP: Plug M8 x 1, color code: BK = +; BN = -; BU = output
Version CC: Plug M12 x 1, color code: BK = +; BN = -; BU = output

Accessories

Plug-in connector cable with nut



Outer cover	Cable length (m)	Weight (kg)	Connector	Connector
PVC 3 x 0,25	5	0,18	M8 x 1	MP73001/5
PUR 3 x 0,25	5	0,18	M8 x 1	MP73002/5
PUR 3 x 0,34	5	0,21	M12 x 1	MP34594/5

- > Magnetically operated solid state switch - round style
- > IO-Link version available
- > Suitable for all cylinder ranges with magnetic piston
- > Switches can be mounted flush in all profile cylinders
- > Reliable switching with a very fast reponse time
- > Particularly suited for use in high levels of vibration
- > LED indicator as standard
- > CE certified
- > UL listed





Technical features

Operation:

M/50/EAP (PNP) open collector output with LED (yellow)

M/50/EAN (NPN) grounded emitter output with LED (yellow)

M/50/IOP (PNP) Easy IO-Link open collector output with LED (yellow)

Switching voltage (Ub):

10 ... 30 VDC

Switching voltage output:

Ub - 2 V

Inducted voltage:

0,5 V

Switching current

(see graph overleaf):

100 mA max.

Switching power:

3,0 W max.

Response time:

< 0,5 ms for EAP switch

< = 1 ms for IOP switch

Operating frequency:

1 kHz

Protection rating (EN 60529):

IP67 (standard)

IP68 for type: M/50/EAP/5U

Operating temperature:

-40 ... +80 °C (-40 ... 176 °F)

(IP67 & IP68)

Cable type:

PVC 3 x 0,12 (standard)

PUR 3 x 0,14 (M/50/EAP/5U)

Cable length:

2, 5 and 10 m

Electromagnetic compatibility

according to:

EN 60947-5-2

Materials:

Body: plastic

Cable: see table below

Technical data - Solid state

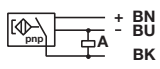
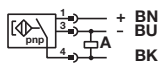
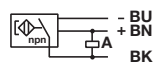
Symbol	Voltage (VDC)	Current maximum (mA)	Function	IO-Link *2)	Operating temperature (°C)	LED	Protection class	Plug	Cable length (m)	Cable type	Weight (g)	Model
	10 ... 30	100	PNP		-40 ... +80	•	IP67	—	2, 5 or 10	PVC 3 x 0,12	37	M/50/EAP/*V
	10 ... 30	100	PNP	•	-40 ... +80	•	IP67	—	5	PVC 3 x 0,12	37	M/50/IOP/5V
	10 ... 30	100	PNP		-40 ... +80	•	IP68	—	5	PUR 3 x 0,14	37	M/50/EAP/5U
	10 ... 30	100	PNP		-40 ... +80	•	IP67	M8 x 1	0,3	PVC 3 x 0,14	16	M/50/EAP/CP *1)
	10 ... 30	100	PNP	•	-40 ... +80	•	IP67	M8 x 1	0,3	PVC 3 x 0,14	16	M/50/IOP/CP *1)
	10 ... 30	100	PNP		-40 ... +80	•	IP67	M12 x 1	0,3	PVC 3 x 0,14	16	M/50/EAP/CC *1)
	10 ... 30	100	NPN		-40 ... +80	•	IP67	—	2, 5 or 10	PVC 3 x 0,12	37	M/50/EAN/*V
	10 ... 30	100	NPN		-40 ... +80	•	IP67	M8 x 1	0,3	PVC 3 x 0,14	16	M/50/EAN/CP *1)

* Insert cable length; *1) Plug-in connector below; Color code: BK = black, BN = brown, BU = blue

IO-Link function *2)

- Visual installation aid
- Counter
- Temperature diagnostic
- Power LED

Switching current and switching voltage

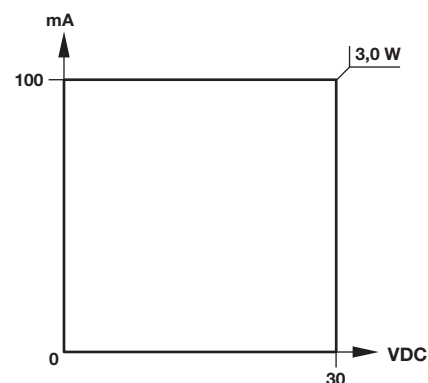

Dimensions

M/50/EAP/*V,
M/50/EAN/*V
M/50/IOP/5V
Cable length L = 2, 5 or 10 m

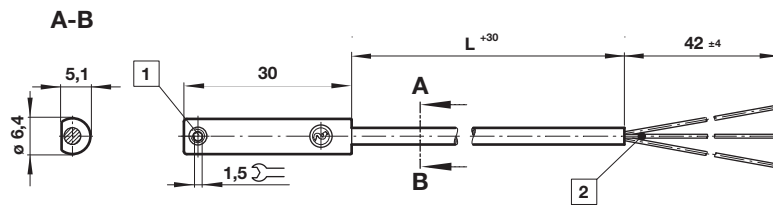

Dimensions in mm
Projection/First angle



M/50/EAP/CP,
M/50/EAN/CP
M/50/IOP/CP

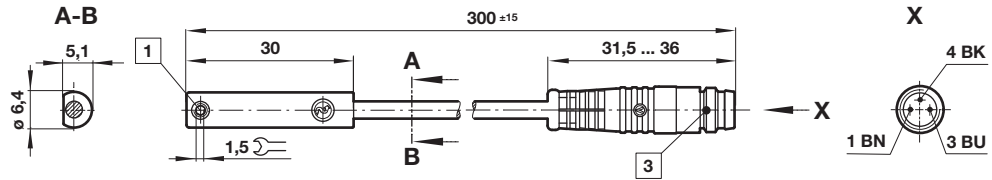

M/50/EAP/CC

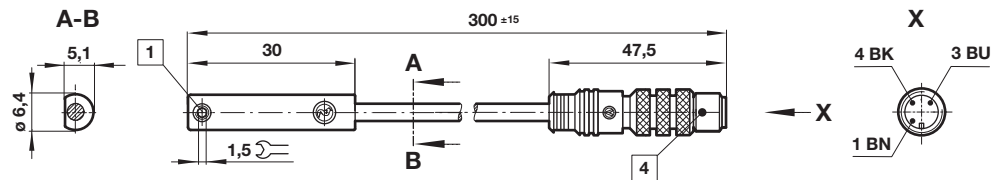

- 1 Fixing screw
- 2 Color code: BK = black; BN = brown; BU = blue
- 3 Plug M8 x 1
- 4 Plug M12 x 1

Accessories

Plug-in connector cable with nut









Outer cover	Cable length (m)	Weight (kg)	Connector	Connector
PVC 3 x 0,25	5	0,18	M8 x 1	M/P73001/5*1)
PUR 3 x 0,25	5	0,18	M8 x 1	M/P73002/5*1)
PVC 3 x 0,25	5	0,18	M8 x 1	M/P34615/5*2)
PUR 3 x 0,25	5	0,18	M8 x 1	M/34596/5*2)
PUR 3 x 0,34	5	0,21	M12 x 1	M/P34594/5*1)

*1) Straight connector

*2) 90 ° Connector

Bus card



Description	SI-PROFINET RT V2	SI-PROFIBUS	SI-EtherNet/IP	SI-EtherCAT	SI-CANopen	SI-DeviceNet
						
Color code	Green	Purple	Cream	Red	White	Grey
Model	QE/B18200/PN	QE/B17500/PB	QE/B17900/EN	QE/B18000/EC	QE/B17600/CO	QE/B17700/DN

Description **SI-I/O**
 Extended I/O interface module to increase the number of analog and digital In- and Outputs on the drive.





Color code Orange
Model QE/B17800/IO





Power cable

Description	Motor cable without brake	Motor cable with brake
		
Cable length	5 m 10 m	5 m 10 m
Model	QE/C5402/08/5 QE/C5402/08/10	QE/C5402/18/5 QE/C5402/18/10

Feedback cable

Description	Feedback cable resolver	Feedback cable Multi Turn
		
Cable length	5 m 10 m	5 m 10 m
Model	QE/F5400/61/5 QE/F5400/61/10	QE/F5400/30/5 QE/F5400/30/10

Drive accessories

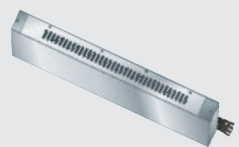
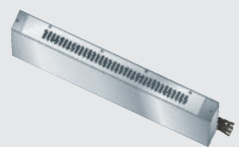
Multiple axis kit short  QE/A9500/1047	long  QE/A9500/1048	USB converter cable  QE/A4500/0096	KI compact display  QE/A20400	EMC filter for	QE/D01400030  QE/A4200/8744	QE/D02400105  QE/A4200/1644
--	---	--	---	-----------------------	---	---

Brake resistor for 50 W **100 W**

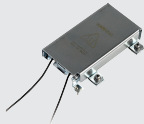

QE/A9500/1049 QE/A1220/2801

Warning

These products should only be used where the values listed under **"Technical features/data"** are not exceeded. Please refer to the corresponding catalogue page. Before using the products in non-industrial applications, in life-support or other systems not included in the published instructions, please contact Norgren directly. Misuse, wear, or malfunction can cause components to fail in a variety of ways.

System designers are strongly recommended to consider the failure modes of all component parts used and to take adequate safety precautions to prevent personal injury and damage to equipment in the event of such failure. System designers and end users are cautioned to review specific warnings found in instruction sheets packed and shipped with these products.