

PROFILE 45 X 90 F

Article Nr. 20.1032/0

[See the product on the website](#) →

[Download CAD Files](#) →

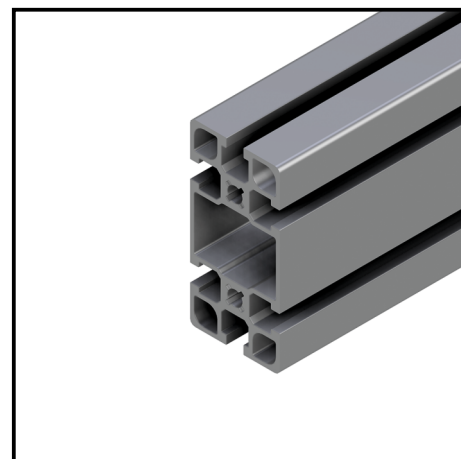
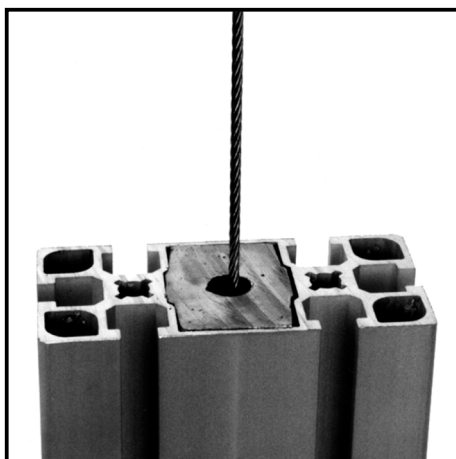
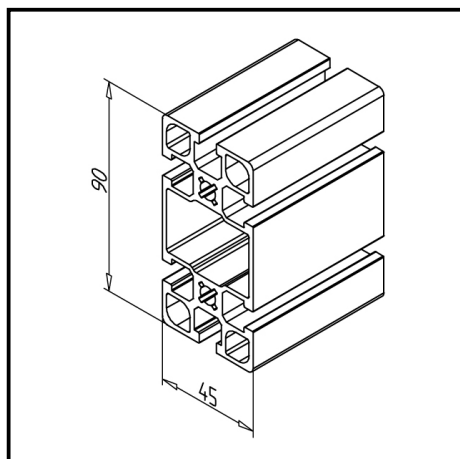

TECHN. DATA / ITEMS SUPPLIED

- Aluminium, extruded, anodized E6/EV1
- $I_x = 100.988 \text{ cm}^4$
- $I_y = 24.34 \text{ cm}^4$
- $w_x = 22.441 \text{ cm}^3$
- $w_y = 10.818 \text{ cm}^3$
- $IT = 60.629 \text{ cm}^4$
- Weight = 3.134 kg/m
- Packing unit = 24 m

APPLICATIONS

- All kinds of constructions
- The hollow chamber is designed for receiving and guiding counterweights

ASSEMBLY

- MiniTec power-lock fastener
- Angle 19 / 25 / 45 / 45 x 90 GD-Z
- Bolt connector