

1686697 VZBA-11/2"-WW-63-T-22-F0507-V4V4T Ball valve - Series: All

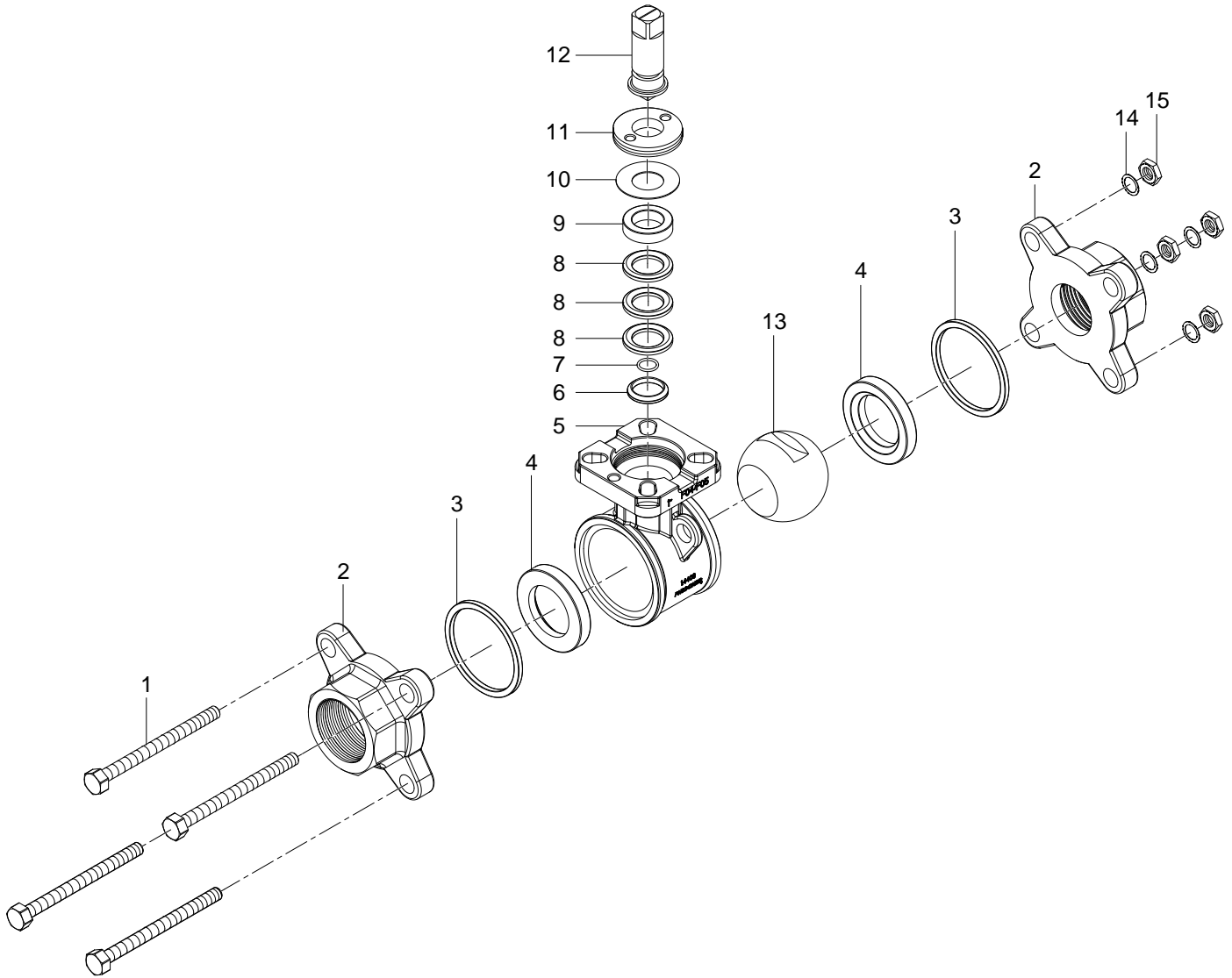

1686697 VZBA-11/2"-WW-63-T-22-F0507-V4V4T Ball valve - Series: All

Pos.	Part no.	Type	Note	Qty.	Unit
A	8000922	VZBA-11/2"-63-T-22-V4V4T Set of wearing parts	Spare parts: 3, 4, 6, 7, 8, 9	1	PC
1			Not available	4	PC
2			Not available	1	PC
3			Not available separately, see position A	2	PC
4			Not available separately, see position A	2	PC
5			Not available	1	PC
6			Not available separately, see position A	1	PC
7			Not available separately, see position A	1	PC
8			Not available separately, see position A	3	PC
9			Not available separately, see position A	1	PC
10			Not available	1	PC
11			Not available	1	PC
12			Not available	1	PC
13	721600	VAPB-1 1/2-F-63-CR Ball		1	PC
14			Not available	4	PC
15			Not available Tightening torque 41 Nm / 30.2 lbf ft	4	PC