

GRT155C81C225KE13#

indicates a package specification code.



< List of part numbers with package codes >
 GRT155C81C225KE13D , GRT155C81C225KE13J

Shape

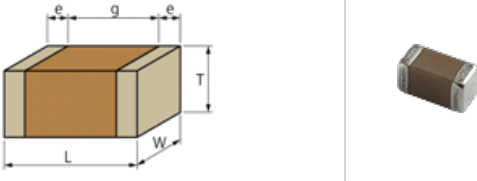

L size	1.0 ±0.2mm
W size	0.5 ±0.2mm
T size	0.5 ±0.2mm
External terminal width e	0.15 to 0.35mm
Distance between external terminals g	0.3mm min.
Size code in inch(mm)	0402 (1005M)

References

Packaging	Specifications	Minimum quantity
D	φ180mm Paper taping	10000
J	φ330mm Paper taping	40000

Mass (typ.)	
1 piece	3.1mg
φ180mm Reel	149g

Specifications

Capacitance	2.2μF ±10%
Rated voltage	16Vdc
Temperature characteristics (complied standard)	X6S(EIA)
Capacitance change rate	±22.0%
Temperature range of temperature characteristics	-55 to 105°C
Operating temperature range	-55 to 105°C

Attention

- 1.This datasheet is downloaded from the website of Murata Manufacturing Co., Ltd. Therefore, it's specifications are subject to change or our products in it may be discontinued without advance notice. Please check with our sales representatives or product engineers before ordering.
- 2.This datasheet has only typical specifications because there is no space for detailed specifications. Therefore, please review our product specifications or consult the approval sheet for product specifications before ordering.

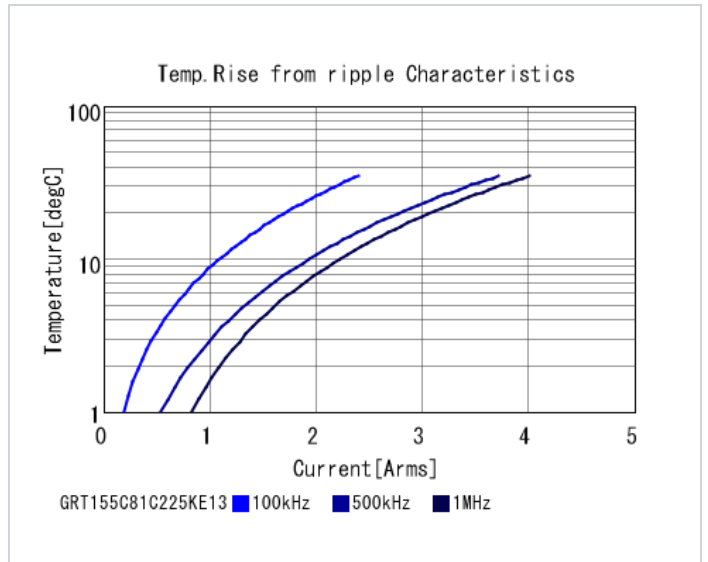
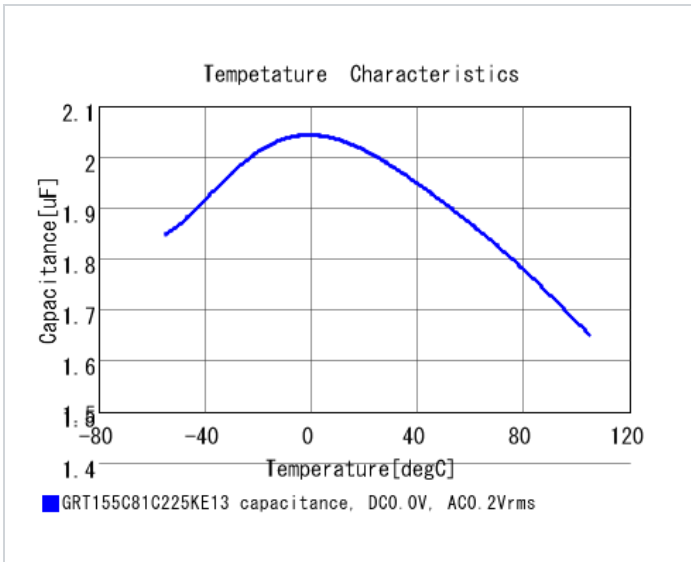
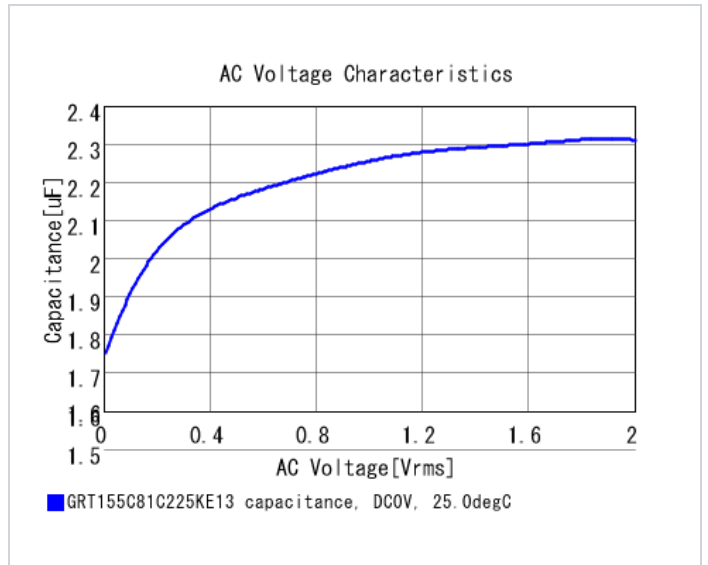
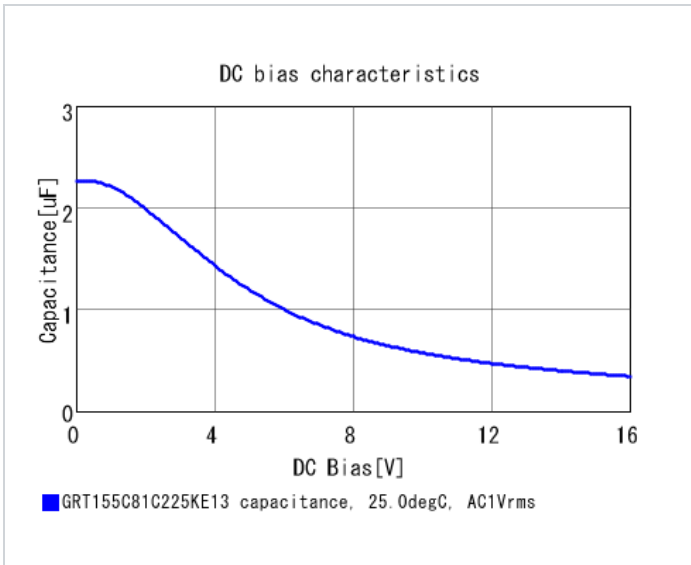
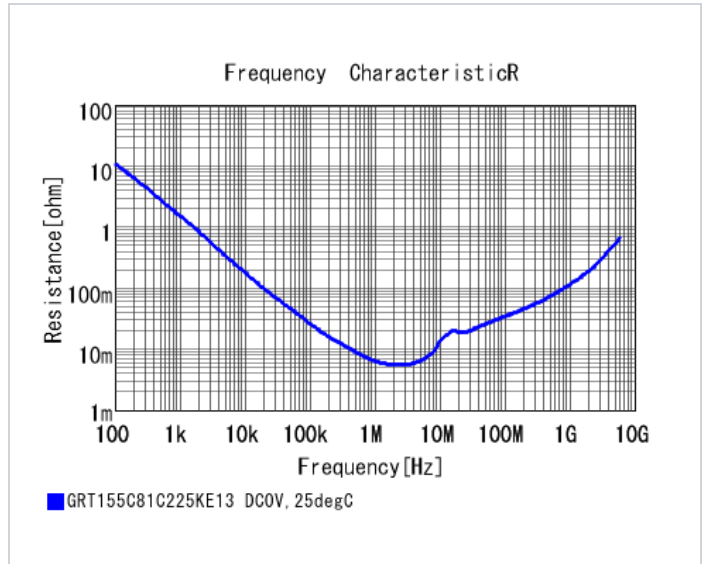
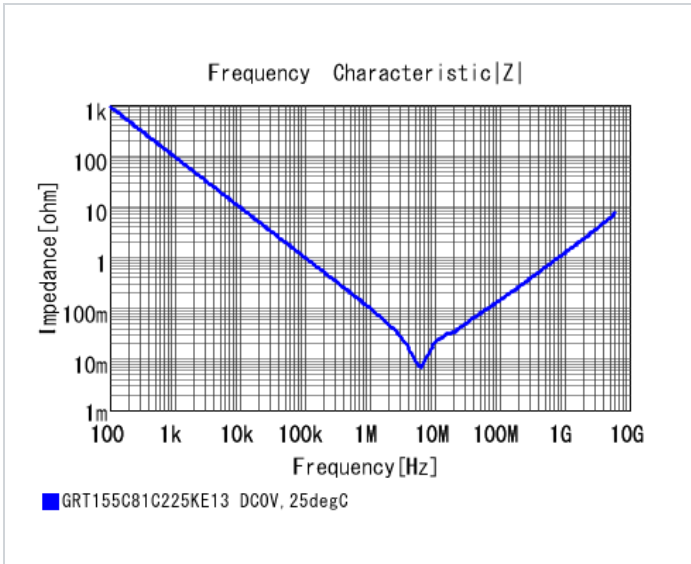

Attention

- 1.This datasheet is downloaded from the website of Murata Manufacturing Co., Ltd. Therefore, it's specifications are subject to change or our products in it may be discontinued without advance notice. Please check with our sales representatives or product engineers before ordering.
- 2.This datasheet has only typical specifications because there is no space for detailed specifications. Therefore, please review our product specifications or consult the approval sheet for product specifications before ordering.