



## Intrinsically Safe Audible Signal - 100 dB (A)

Series YO4IS



## Contents

1	General Information .....	2
1.1	Manufacturer .....	2
1.2	Information regarding the operating instructions .....	3
1.3	Further documents .....	3
1.4	Conformity with standards and regulations .....	3
2	Explanation of the symbols .....	3
2.1	Symbols in these operating instructions .....	3
2.2	Warning notes .....	3
2.3	Symbols on the device .....	4
3	Safety notes .....	4
3.1	Operating instructions storage .....	4
3.2	Safe use .....	5
3.3	Modifications and alterations .....	5
4	Function and device design .....	5
4.1	Function .....	6
5	Technical data .....	6
6	Transport and storage .....	7
7	Mounting and installation .....	7
7.1	Dimensions / fastening dimensions .....	9
7.2	Mounting / dismounting, operating position .....	9
7.3	Installation .....	10
8	Commissioning .....	15
9	Maintenance and repair .....	16
9.1	Maintenance .....	16
9.2	Repair .....	16
9.3	Returning the device .....	16
10	Cleaning .....	16
11	Disposal .....	17
12	Accessories and Spare parts .....	17

## 1 General Information

### 1.1 Manufacturer

R. Stahl Schaltgeräte GmbH  
Am Bahnhof 30  
74638 Waldenburg  
Germany

Phone: +49 7942 943-0  
Fax: +49 7942 943-4333  
Internet: [www.stahl-ex.com](http://www.stahl-ex.com)  
E-mail: [info@stahl.de](mailto:info@stahl.de)

R. STAHL (P) LTD., Plot No. - 5  
Malrosapuram Road, Sengundram Indl. Area  
Singaperumal Koil, Kancheepuram Dist.,  
Tamil Nadu 603 204, INDIA

Phone: +91 44-30 600 600  
Fax: +91 44-30 600 700  
Internet: [www.rstahl.net](http://www.rstahl.net)  
E-mail: [sales@rstahl.net](mailto:sales@rstahl.net)

## 1.2 Information regarding the operating instructions

ID-No.: 252154 / YO460300010  
 Publication Code: 2016-03-24-BA00-III-en-00

The original instructions are the English edition.  
 They are legally binding in all legal affairs.

## 1.3 Further documents

- Data sheet





For documents in further languages, see [www.stahl-ex.com](http://www.stahl-ex.com).

## 1.4 Conformity with standards and regulations

See certificates and EC Declaration of Conformity: [www.stahl-ex.com](http://www.stahl-ex.com).  
 The device has IECEx approval. See IECEx homepage: <http://iecex.iec.ch/>

# 2 Explanation of the symbols



## 2.1 Symbols in these operating instructions

Symbol	Meaning
	Tips and recommendations on the use of the device
	General danger
	Danger due to explosive atmosphere
	Danger due to energised parts





## 2.2 Warning notes

Warnings must be observed under all circumstances, in order to minimize the risk due to construction and operation. The warning notes have the following structure:

- Signalling word: DANGER, WARNING, CAUTION, NOTICE
- Type and source of danger/damage
- Consequences of danger
- Taking countermeasures to avoid the danger or damage

	<b>DANGER</b>
	Danger to persons Non-compliance with the instruction results in severe or fatal injuries to persons.
	<b>WARNING</b>
	Danger to persons Non-compliance with the instruction can result in severe or fatal injuries to persons.
	<b>CAUTION</b>
	Danger to persons Non-compliance with the instruction can result in light injuries to persons.
<b>NOTICE</b>	
Avoiding material damage Non-compliance with the instruction can result in material damage to the device and / or its environment.	

### 2.3 Symbols on the device

Symbol	Significance
 <small>05594E00</small>	CE marking according to the current applicable directive.
 <small>02198E00</small>	According to its marking, the device is certified for hazardous areas.
 <small>15649E00</small>	Input
 <small>15648E00</small>	Output
 <small>11048E00</small>	Safety instructions that must always be followed: The respective data must be noted and/or the safety-related instructions contained in the operating instructions must be followed for devices with this symbol!

## 3 Safety notes



### 3.1 Operating instructions storage

- Read the operating instructions carefully.
- Store the operating instructions at the mounting location of the device.
- Observe applicable documents and operating instructions of the devices to be connected.

### 3.2 Safe use

- Read and observe the safety notes in these operating instructions!
- Observe characteristic values and rated operating conditions on the rating and data plates!
- Observe additional information plates on the device!
- Use the device in accordance with its intended and approved purpose only!
- We cannot be held liable for damage caused by incorrect or unauthorized use or by non-compliance with these operating instructions.
- Before installation and commissioning, make sure that the device is not damaged!
- Work on the device (installation, maintenance, overhaul, repair) may only be carried out by appropriately authorized and trained personnel.
- During installation and operation, observe the information (characteristic values and rated operating conditions) on the rating, data and information plates located on the device.
- Only connect the power supply if certified safety barriers are in place (refer also to the "Technical data" chapter).
- The safety characteristic values of the connected field devices must match the specifications of the corresponding device.
- When interconnecting intrinsically safe circuits, the safety-related maximum values of field devices and corresponding equipment as well as cable parameters must be observed. This "verification of intrinsic safety" must be performed and documented according to IEC/EN 60079-14 or IEC/EN 60079-25.

### 3.3 Modifications and alterations

	<p style="text-align: center;"><b>DANGER</b></p> <p>Explosion hazard due to modifications and alterations to the device! Non-compliance results in severe or fatal injuries.</p> <ul style="list-style-type: none"> <li>• Do not modify or alter the device.</li> </ul>
	<p>No liability or warranty for damage resulting from modifications and alterations.</p>

## 4 Function and device design

	<p style="text-align: center;"><b>DANGER</b></p> <p>Explosion hazard due to improper use! Non-compliance results in severe or fatal injuries.</p> <ul style="list-style-type: none"> <li>• Use the device only in accordance with the operating conditions described in these operating instructions.</li> <li>• Use the device only for the intended purpose specified in these operating instructions.</li> </ul>
---	---

## 4.1 Function

### Application range

Product Series YO4IS is designed to provide an audible alarm which can be used to alert, warn or draw attention to machine malfunction/start up or any number of safety related issues. In hazardous areas the devices have explosion protection for ATEX/IECEx Zones 0, 1 & 2 for gas and 20, 21 & 22 for dust.



## 5 Technical data

### Explosion Protection

Europe (ATEX)

Gas and dust

BAS02ATEX1190X

YO\*/IS\*/T4  II 1 G Ex ia IIC T4 Ga  
 II 1 D Ex ia IIIC T190°C Da

YO\*/IS\*/T6  II 1 G Ex ia IIC T6 Ga  
 II 1 D Ex ia IIIC T75°C Da

Certifications and certificates

Certificates

ATEX, India (PESO)

### Technical Data

Electrical data

Rated operational voltage

16.2 ... 26.4 V

Current consumption

Power supply	Certified barrier / isolator parameters	Current consumption	Sound output dB (A) / 1 m
24 V DC	28 V / 300 Ω	25 mA	100 dB (A) / 1 m
18 V DC	28 V / 300 Ω	20 mA	98 dB (A) / 1 m

Certified input parameters

$U_i = 30 \text{ V}$   
 $I_i = 133 \text{ mA}$   
 $P_i = 0.7 \text{ W}$   
 $C_i = 0$   
 $L_i = 0$

Line monitoring

yes

Acoustic data

Volume

max. 100 dB(A) / 1 m

Volume control

15 dB(A) adjustment (T4 Models only)

Sound stages

2

Sound selection

via DIL-switch

**Technical Data**

## Ambient conditions

Operating temperature range	-25 to +40°C
Storage temperature	-40 to +70°C
Max. relative humidity	95 % at 40 °C

## Mechanical data

Cable entries	1 x M20
Material	
Enclosure	ABS, flame retardant
Assembly parts	stainless steel fixings
Labels	polyester foil, adhesive
Degree of protection	IP55 acc. to IEC 60529

## Mounting / Installation

Mounting	Should be mounted to a reasonably flat wall or bulkhead of suitable material using the lugs projecting from the side of the enclosure. The minimum recommended length of fixing screws is 25 mm. To maintain the integrity of the weather seal the cable entry must be fitted using a suitable sealed gland.
Connection	Each sounder should be wired independently. 2.5 mm <sup>2</sup> terminals

For further technical data, see [www.stahl-ex.com](http://www.stahl-ex.com).

**6 Transport and storage**

- Transport and store the device only in the original packaging.
- Store the device in a dry place (no condensation) and vibration-free.
- Do not drop the device.

**7 Mounting and installation**

The device is approved for use in gas explosion hazardous areas of Zones 1 and 2 and dust explosion hazardous area of Zones 21 and 22 and in safe areas.

	DANGER
	<p>Explosion hazard due to installation without approved field enclosure! Non-compliance results in severe or fatal injuries!</p> <ul style="list-style-type: none"> <li>• When used in Zone 1, the device must be installed into an enclosure that complies with the requirements of IEC/EN 60079-11.</li> <li>• When used in Zone 2, the device must be installed into an enclosure that complies with the requirements of IEC/EN 60079-15.</li> <li>• When used in Zones 21 and 22, the device must be installed into an enclosure that complies with the requirements of IEC/EN 60079-31.</li> </ul>

	DANGER
	<p>Explosion hazard due to incorrect installation of the device! Non-compliance results in severe or fatal injuries.</p> <ul style="list-style-type: none"> <li>Carry out installation strictly according to the instructions and national safety and accident prevention regulations to maintain the explosion protection.</li> <li>Select and install the electrical device so that explosion protection is not affected due to external influences, i.e. pressure conditions, chemical, mechanical, thermal and electric impact such as vibration, humidity and corrosion (see IEC/EN 60079-14).</li> <li>The device must only be installed by trained qualified personnel who is familiar with the relevant standards.</li> </ul>

	DANGER
	<p>Explosion hazard due to improper mains power connection! Non-compliance results in severe or fatal injuries.</p> <ul style="list-style-type: none"> <li>Under no circumstances is the device to be supplied using a regular power supply. It is only to be connected using certified barriers/isolators (see "Technical data")</li> </ul>

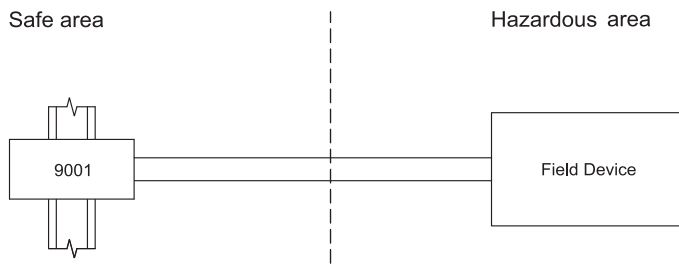

Example of a standard installation using an intrinsically safe field device. Product series 9001 is a safety barrier manufactured by STAHL. Certified components from other manufactures are acceptable. 17769E00



## 7.1 Dimensions / fastening dimensions

Dimensional Drawings (All Dimensions in mm [inches]) - Subject to Alterations

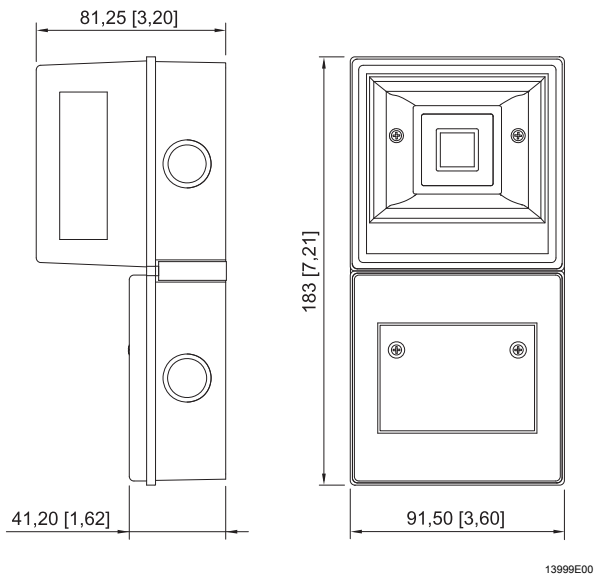

## 7.2 Mounting / dismounting, operating position

### 7.2.1 Assembly

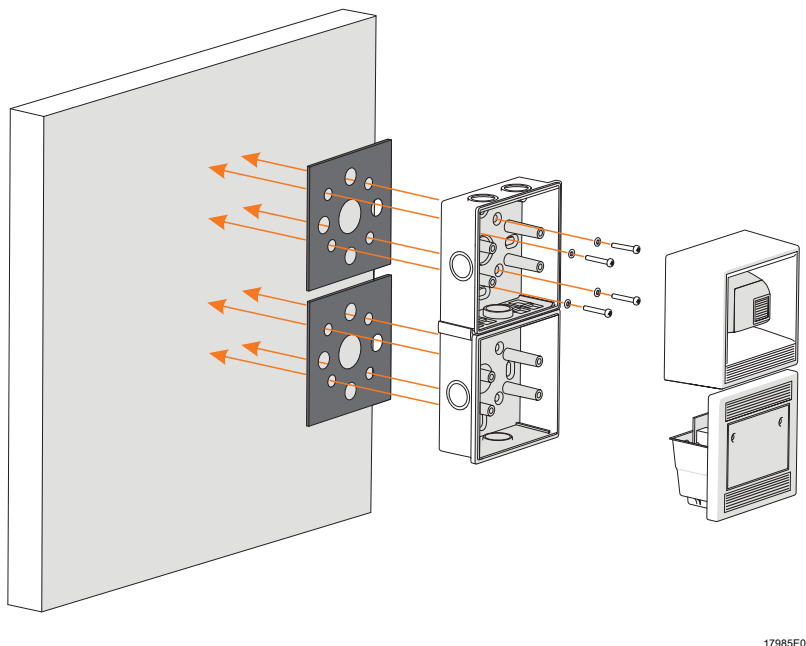

- Open the device.
- Drill holes for mounting the back of the enclosure to a flat surface.
- Install the seal for the IP protective enclosure that was included in delivery.
- Mount the device to the surface, as depicted.
- Close the enclosure.

### 7.3 Installation

	DANGER
	<p>Explosion hazard due to incorrect installation!                  Non-compliance results in severe or fatal injuries.</p> <ul style="list-style-type: none"> <li>• During installation and operation observe the information (characteristic values and rated operating conditions) on the rating, data and information plates located on the device.</li> <li>• The safety characteristic values of the connected field devices must match specifications of the associated apparatus.</li> </ul>

#### 7.3.1 Key components

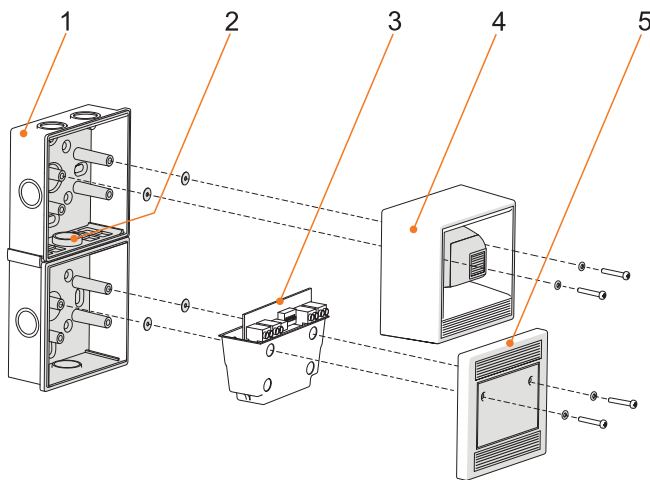

- 1 Lower enclosure part
- 2 Through hole
- 3 Sounder PCB
- 4 Sounder front cover
- 5 Sounder PCB cover

17986E00

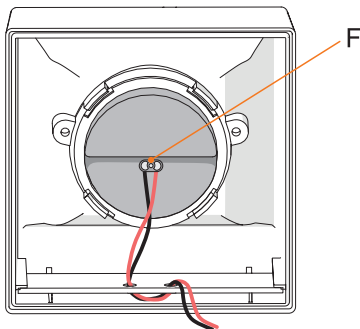

F Sounder pressure transducer

17774E00

#### Prewiring

The sound pressure transducer (F) is fixed to the back side of the sounder front cover (4). It is prewired to the sounder PCB (3).

	<p>Do not separate the cables during installation.</p>
---	--

### 7.3.2 Electrical Connection

#### PCB

- Remove the sounder PCB cover.
- Connect the leads according to the circuit diagram.
- Replace the PCB and lens covers.

### 7.3.3 Circuit diagrams

#### Single stage alarm

- Connect the leads according to the circuit diagram.
- Supply the active device with power.

	<b>DANGER</b>
	<p>Explosion hazard due to selecting the wrong cables! Non-compliance results in severe or fatal injuries.</p> <ul style="list-style-type: none"> <li>• If using separate safety barriers for the sounder and beacon, observe the cable specifications stated on the selected Zener barrier or on the isolator certificate.</li> </ul>

- A single-channel safety barrier or single intrinsically safe connection is required

#### Sounder PCB

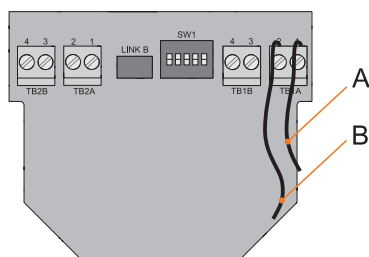

A 0v  
B +v

17775E00

### Two stage alarm

#### Tone selection of the sound stages

	<p>The device has a first and second sound stage.</p> <p><b>First sound stage</b></p> <ul style="list-style-type: none"> <li>• Users can select a tone frequency from 32 different variations using the DIL switch (see diagrams above). Each tone is described in the tone table.</li> </ul> <p><b>Second sound stage</b></p> <ul style="list-style-type: none"> <li>• Each first sound stage has a pre-programmed second stage which is listed in the tone table.</li> <li>• Users are able to switch between the first and second sound stages by wiring the unit in one of two ways.</li> </ul>
---	---

### 7.3.4 Sound tone switching Sound tone switching by using a third cable

Connect the leads according to the figure.

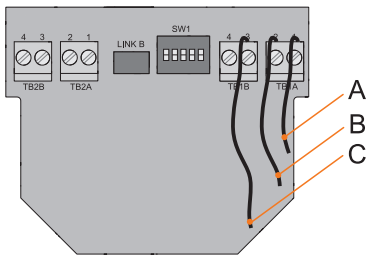

A 0v  
B +v  
C +v

17778E00

- Supply "B" with power to activate the first sound tone frequency.
- Supply "B" and "C" with power according to the circuit diagram for the second tone frequency.
- A dual-channel barrier or double intrinsically safe connection is required.

### Tone switching using reverse polarity

- Connect the leads according to the figure.
- Supply with power to activate the first sound tone frequency.

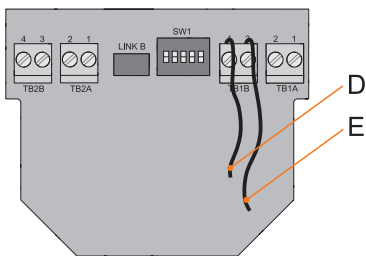

D 0v  
E +v

17779E00

- Reverse the polarity to activate the second sound tone frequency. The sounder PCB and beacon PCB must be wired independently if using reverse polarity to switch between sound tone frequencies.

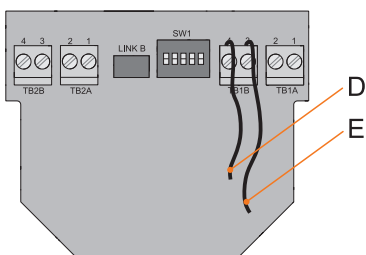

D +v  
E 0v

17779E00

### 7.3.5 Line monitoring



If line monitoring is required, this can be achieved by using an end-of-line resistor. For this purpose, use a wire-wound or metal layer resistor with a resistance value of at least 750 Ohm and a rated power of at least 2 W or at least 4700 Ohm and a rated power of at least 0.4 W!

The line monitoring facility allows the integrity of the line to the sounder to be monitored through the barrier to the control system fault detection and indication circuits. Two sounders of the same type can be connected in parallel. The resistor can be fitted as per the diagram below.

Line monitoring is optional. The system designer should inform users if this is necessary or not.

Standard termination with monitoring resistor fitted.

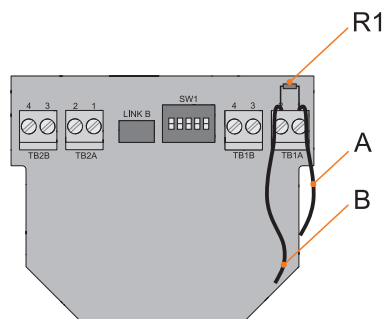

R1 Resistor - Value to be defined by system designer

A 0v

B +v

17782E00

### 7.3.6 Sound tone selection

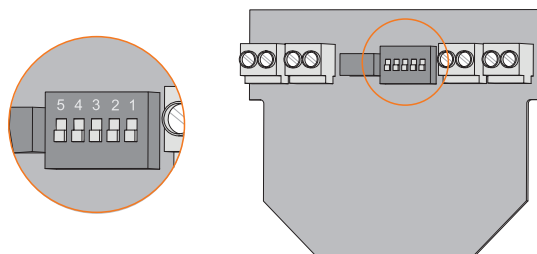

17784E00

- Arrange the settings of the DIP switch using a suitable tool:
  - DIP switch "up" corresponds to "1"
  - DIP switch "down" corresponds to "0"

Refer to the following tone table for the tone selection.

## Tone table

First sound level signal.	Tone description	Frequency [Hz]	Repetition frequency [sec]	Second sound level signal.	Tone changes 1 2 3 4 5	Output [db(A)]	Input current [mA]
1	Two alternating tones	800-1000	0.5	3	1 1 1 1 1	100	26
2	Two alternating tones	2500-3100	0.5	4	0 1 1 1 1	102	34
3	Two alternating tones	800-1000	0.25	7	1 0 1 1 1	100	25
4	Two alternating tones	2500-3100	0.25	8	0 0 1 1 1	103	34
5	Two alternating tones	440-554	0.4/0.1	14	1 1 0 1 1	98	24
6	Two alternating tones	430-470	1.0	14	0 1 0 1 1	98	24
7	Two alternating tones	800-1000	0.13	12	1 0 0 1 1	100	25
8	Two alternating tones	2500-3200	0.07	13	0 0 0 1 1	102	34
9	Two alternating tones	440-554	2.0	10	1 1 1 0 1	98	24
10	Continuous tone	700	∅	1	0 1 1 0 1	99	25
11	Continuous tone	1000	∅	31	1 0 1 0 1	98	24
12	Continuous tone	1000	∅	7	0 0 1 0 1	101	25
13	Continuous tone	2300	∅	2	1 1 0 0 1	101	30
14	Continuous tone	440	∅	9	0 1 0 0 1	98	24
15	Interrupted tone	1000	2.0	31	1 0 0 0 1	97	24
16	Interrupted tone	420	1.25	30	0 0 0 0 1	97	24
17	Interrupted tone	1000	0.5	1	1 1 1 1 0	98	24
18	Interrupted tone	2500	0.25	4	0 1 1 1 0	101	30
19	Interrupted tone	2500	0.5	2	1 0 1 1 0	101	29
20	Interrupted tone	700	6/12	10	0 0 1 1 0	100	24
21	Interrupted tone	1000	1.0	32	1 1 0 1 0	99	24
22	Interrupted tone	700	4.0	10	0 1 0 1 0	99	24
23	Interrupted tone	700	0.25	10	1 0 0 1 0	97	23
24	Interrupted tone	720	0.7/0.3	10	0 0 0 1 0	99	24
25	Interrupted, fast, rising volume	1400	0.25	26	1 1 1 0 0	101	28
26	Fast siren	250-1200	0.085	11	0 1 1 0 0	99	24
27	Rising, falling constantly	1000	10/40/10	17	1 0 1 0 0	100	25
28	ISO 8201 Evacuation	800-1000	As standard	11	0 0 1 0 0	97	23
29	Fast wailing noise	500-1000	0.15	32	1 1 0 0 0	99	25
30	Slow wailing noise	500-1200	4.5	12	0 1 0 0 0	100	25
31	Reverse sweep	1200-500	1.0	11	1 0 0 0 0	98	24
32	Siren	500-1200	3.0	26	0 0 0 0 0	98	24

### 7.3.7 Volume control

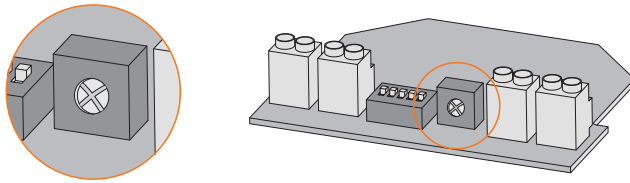

17785E00



The product is supplied with the volume set to full.

- Upon request, the volume can be reduced by turning the potentiometer anticlockwise.

### 7.3.8 Earth connection

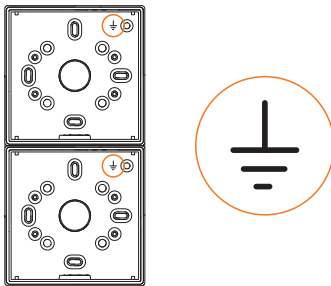

17987E00

## 8 Commissioning



### DANGER

Explosion hazard due to incorrect installation!

Non-compliance results in severe or fatal injuries.

- Check the device for proper installation before commissioning.
- Comply with national regulations.

Before commissioning, ensure the following:

- Check the mounting and installation.
- Enclosure must not be damaged.
- If necessary, remove foreign bodies.
- If necessary, clean the connection chamber.
- Check if the conductors have been inserted correctly.
- Check if all screws and nuts have been tightened firmly.
- Check if all conductors have been clamped firmly.
- Check if all prescribed tightening torques have been observed.
- Check whether the bayonet lock is tightened firmly.
- Make sure that the plug pin surface is not damaged.
- Use only in completely mounted state.

## 9 Maintenance and repair

The provisions of IEC/EN 60079-17 or the national rules and regulations apply to maintenance work to be regularly performed on explosion-protected and associated operating equipment.

	<b>CAUTION</b>
	<p>Risk of electric shock or malfunction of the device due to unauthorized work! Non-compliance can result in light injuries!</p> <ul style="list-style-type: none"> <li>• Before carrying out work on the device, switch off voltage supply.</li> <li>• Work performed on the device must only be carried out by authorized and appropriately trained qualified electricians.</li> </ul>

### 9.1 Maintenance

	Observe the relevant national regulations in the country of use.
---	--

### 9.2 Repair

	<b>DANGER</b>
	<p>Explosion hazard due to improper repair! Non-compliance results in severe or fatal injuries.</p> <ul style="list-style-type: none"> <li>• Repair work on the devices must be performed only by R. STAHL Schaltgeräte GmbH.</li> </ul>

### 9.3 Returning the device

Use the "Service form" to return the device if repair or service is required. On the internet site "[www.stahl-ex.com](http://www.stahl-ex.com)" under "Downloads > Customer service":

- Download the service form.
- Fill out the service form.
- Send the device along with the service form in the original packaging to R. STAHL Schaltgeräte GmbH.

## 10 Cleaning

- To avoid electrostatic charging, the devices located in potentially explosive areas may only be cleaned using a damp cloth.
- When cleaning with a damp cloth, use water or mild, non-abrasive, non-scratching cleaning agents.
- Do not use aggressive detergents or solvents.



## 11 Disposal

- Observe national and local regulations and statutory regulation regarding disposal.
- Separate materials when sending it for recycling.
- Ensure environmentally friendly disposal of all components according to the statutory regulations.

## 12 Accessories and Spare parts

### *NOTE*

Malfunction or damage to the device due to the use of non-original components.  
Non-compliance can result in material damage.

- Use only original accessories and spare parts from R. STAHL Schaltgeräte GmbH.



For accessories and spare parts, see data sheet on our homepage  
[www.stahl-ex.com](http://www.stahl-ex.com).

**EG/EU-Konformitätserklärung**  
*EC/EU Declaration of Conformity*  
*Déclaration de Conformité CE/UE*



**R. STAHL Schaltgeräte GmbH • Am Bahnhof 30 • 74638 Waldenburg, Germany**  
 erklärt in alleiniger Verantwortung, *declares in its sole responsibility, déclare sous sa seule responsabilité,*

dass das Produkt: **Eigensicheres akustisches Signal - 100 dB (A)**  
*that the product: Intrinsically Safe Audible Signal - 100 dB(A)*  
*que le produit: Avertisseur sonore et lumineux de sécurité intrinsèque – 100 dB(A)*

Typ(en), type(s), type(s): **YO4IS**

mit den Anforderungen der folgenden Richtlinien und Normen übereinstimmt.  
*is in conformity with the requirements of the following directives and standards.*  
*est conforme aux exigences des directives et des normes suivantes.*

Richtlinie(n) <i>Directive(s)</i> <i>Directive(s)</i>		Norm(en) <i>Standard(s)</i> <i>Norme(s)</i>
<b>Bis/Until/Jusque</b> <b>2016-04-19:</b>	<b>Ab/From/De</b> <b>2016-04-20:</b>	EN 60079-0:2012 + A11:2013 EN 60079-11:2012 EN 60079-31: 2014
<b>94/9/EG:</b> ATEX-Richtlinie	<b>2014/34/EU:</b>	
<b>94/9/EC:</b> ATEX Directive	<b>2014/34/EU:</b>	
<b>94/9/CE:</b> Directive ATEX	<b>2014/34/UE:</b>	

Kennzeichnung, marking, marquage:

II 1 G Ex ia IIC T\* Ga  
 II 1 D Ex ia IIIC T\*\*\*C Da

**CE 0158**

EG-Baumusterprüfbescheinigung:  
*EC Type Examination Certificate:*  
*Attestation d'examen CE de type:*

**BAS 02 ATEX 1190X**  
 (Baseefa Ltd., Rockhead Business Park Staden Lane, Buxton Derbyshire, SK17 9RZ United Kingdom)

Produktnormen nach Niederspannungsrichtlinie:  
*Product standards according to Low Voltage Directive:*  
*Normes des produit pour la Directive Basse Tension:*

EN 60947-1: 2007 + A1: 2011/A2:2014

<b>Bis/Until/Jusque</b> <b>2016-04-19:</b>	<b>Ab/From/De</b> <b>2016-04-20:</b>	EN 61000-6-1: 2007 EN 61000-6-2: 2006 EN 61000-6-3: 2007 + A1: 2011 / AC:2012 EN 61000-6-4: 2007 + A1: 2011
<b>2004/108/EG:</b> EMV-Richtlinie	<b>2014/30/EU:</b>	
<b>2004/108/EC:</b> EMC Directive	<b>2014/30/EU:</b>	
<b>2004/108/CE:</b> Directive CEM	<b>2014/30/UE:</b>	

<b>2011/65/EU</b> RoHS-Richtlinie	EN 50581:2012
<b>2011/65/EU</b> RoHS Directive	
<b>2011/65/UE</b> Directive RoHS	

Waldenburg, 01.02.2016

i.V.

**Ort und Datum**  
*Place and date*  
*Lieu et date*

**Dr. A. Kaufmann**  
 Leiter BU Leuchten & Signalgeräte  
*Head of BU Lightings & Signalling*  
*Directeur BU Eclairage & Appareils de Signal*

i.V.

**J.-P. Rückgauer**  
 Leiter Qualitätsmanagement  
*Director Quality Management*  
*Directeur Assurance de Qualité*