

## ZB5AG212

selector switch head Ø22 2-position stay put Ronis 421E



### Main

Range of product	Harmony XALF Harmony XB5
Product or component type	Head for key selector switch
Device short name	ZB5
Bezel material	Plastic
Mounting diameter	22 mm
Sale per indivisible quantity	1
Shape of signaling unit head	Round
Type of operator	Stay put
Operator profile	Black key switch
Operator position information	2 positions 90°
Type of keylock	Ronis 421E
Key withdrawal position	Left

### Complementary

CAD overall width	29 mm
CAD overall height	29 mm
CAD overall depth	72 mm
Product weight	0.057 kg
Mechanical durability	1000000 cycles
Station name	XALD 1...5 cut-outs XALK 2...5 cut-outs
Electrical composition code	C11 for <= 3 contacts using single blocks in front mounting C15 for 1 contacts using single blocks in front mounting SF1 for <= 3 contacts using single blocks in front mounting SR1 for <= 3 contacts using single blocks in rear mounting C3 for <= 6 contacts using single blocks in front mounting C4 for <= 6 contacts using single and double blocks in front mounting C7 for <= 4 contacts using single blocks in front mounting C8 for <= 4 contacts using single and double blocks in front mounting C5 for <= 5 contacts using single blocks in front mounting C6 for <= 5 contacts using single and double blocks in front mounting

### Environment

protective treatment	TH
ambient air temperature for storage	-40...70 °C
ambient air temperature for operation	-40...70 °C
overvoltage category	Class II conforming to IEC 60536
IP degree of protection	IP67 IP66 conforming to IEC 60529 IP69K IP69
NEMA degree of protection	NEMA 13 NEMA 4X
resistance to high pressure washer	7000000 Pa at 55 °C, distance: 0.1 m
IK degree of protection	IK06 conforming to IEC 50102
standards	EN/IEC 60947-1 EN/IEC 60947-5-1 EN/IEC 60947-5-4 JIS C 4520 UL 508 CSA C22.2 No 14
product certifications	BV

The information provided in this documentation contains general descriptions and/or technical characteristics of the products contained herein. This documentation is not intended as a substitute for and is not to be used for determining suitability or reliability of these products for specific user applications. It is the duty of any such user or integrator to perform the appropriate and complete risk analysis, evaluation and testing of the products with respect to the relevant specific application or use thereof. Neither Schneider Electric Industries SAS nor any of its affiliates or subsidiaries shall be responsible or liable for misuse of the information contained herein.

CSA  
 DNV  
 GL  
 LROS (Lloyds register of shipping)  
 RINA  
 UL listed

vibration resistance	5 gn (f = 2...500 Hz) conforming to IEC 60068-2-6
shock resistance	30 gn (duration = 18 ms) for half sine wave acceleration conforming to IEC 60068-2-27 50 gn (duration = 11 ms) for half sine wave acceleration conforming to IEC 60068-2-27

### Contractual warranty

Warranty period	18 months
-----------------	-----------

### Dimensions

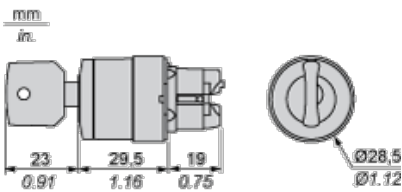

### Panel Cut-out for Pushbuttons, Switches and Pilot Lights (Finished Holes, Ready for Installation)

#### Connection by Screw Clamp Terminals or Plug-in Connectors or on Printed Circuit Board

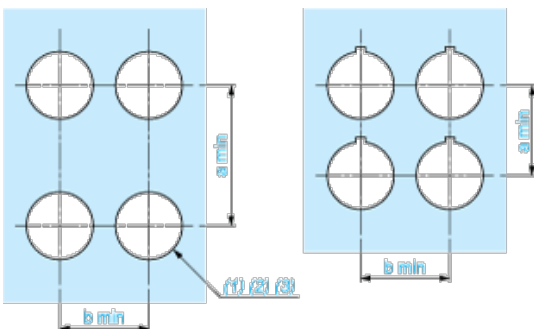

- (1) Diameter on finished panel or support
- (2) For selector switches and Emergency stop buttons, use of an anti-rotation plate type ZB5AZ902 is recommended.
- (3) Ø22.5 mm recommended ( $\text{Ø}22.3_{0}^{+0.4}$ ) / Ø0.89 in. recommended ( $\text{Ø}0.88 \text{ in.}_{0}^{+0.016}$ )

Connections	a in mm	a in in.	b in mm	b in in.
By screw clamp terminals or plug-in connector	40	1.57	30	1.18
By Faston connectors	45	1.77	32	1.26
On printed circuit board	30	1.18	30	1.18

#### Detail of Lug Recess

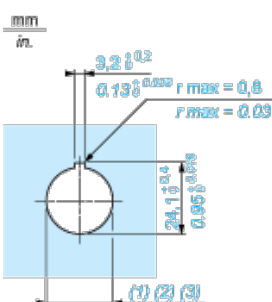

- (1) Diameter on finished panel or support
- (2) For selector switches and Emergency stop buttons, use of an anti-rotation plate type ZB5AZ902 is recommended.

(3)  $\varnothing 22.5$  mm recommended ( $\varnothing 22.3_{0}^{+0.4}$ ) /  $\varnothing 0.89$  in. recommended ( $\varnothing 0.88$  in.  $_{0}^{+0.016}$ )

## Pushbuttons, Switches and Pilot Lights for Printed Circuit Board Connection

### Panel Cut-outs (Viewed from Installer's Side)

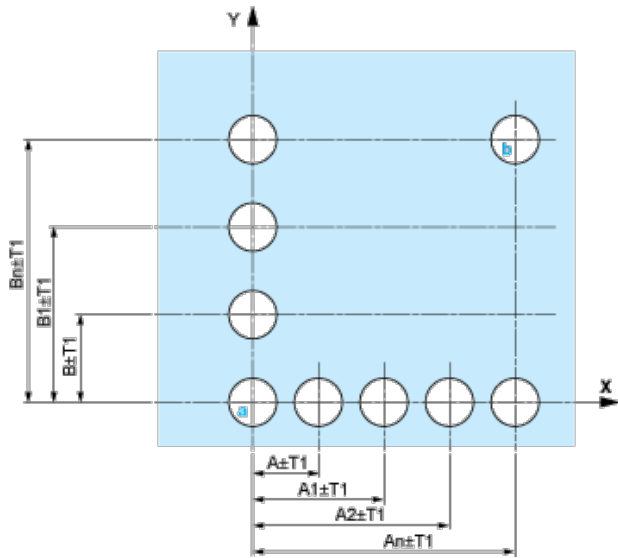

A: 30 mm min. / 1.18 in. min.

B: 40 mm min. / 1.57 in. min.

### Printed Circuit Board Cut-outs (Viewed from Electrical Block Side)

Dimensions in mm

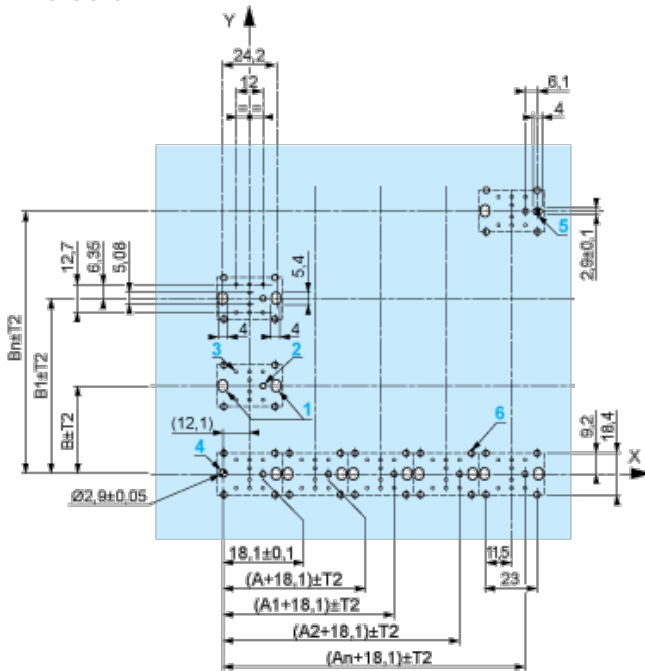

A: 30 mm min.

B: 40 mm min.

Dimensions in in.



A: 1.18 in. min.

B: 1.57 in. min.

### General Tolerances of the Panel and Printed Circuit Board

The cumulative tolerance must not exceed 0.3 mm / 0.012 in.:  $T1 + T2 = 0.3 \text{ mm max.}$

### Installation Precautions

- | Minimum thickness of circuit board: 1.6 mm / 0.06 in.
- | Cut-out diameter: 22.4 mm  $\pm$  0.1 / 0.88 in.  $\pm$  0.004
- | Orientation of body/fixing collar ZB5AZ009:  $\pm$  2°30' (excluding cut-outs marked **a** and **b**).
- | Tightening torque of screws ZBZ006: 0.6 N.m (5.3 lbf.in) max.
- | Allow for one ZB5AZ079 fixing collar/pillar and its fixing screws:
  - | every 90 mm / 3.54 in. horizontally (X), and 120 mm / 4.72 in. vertically (Y).
  - | with each selector switch head (ZB5AD•, ZB5AJ•, ZB5AG•).

The fixing centers marked **a** and **b** are diagonally opposed and must align with those marked 4 and 5.



- (1) Head ZB5AD•
- (2) Panel
- (2) Nut
- (4) Printed circuit board

### Mounting of Adapter (Socket) ZBZ01•

- | 1 2 elongated holes for ZBZ006 screw access
- | 2 1 hole  $\varnothing$  2.4 mm  $\pm$  0.05 / 0.09 in.  $\pm$  0.002 for centring adapter ZBZ01•
- | 3 8  $\times$   $\varnothing$  1.2 mm / 0.05 in. holes
- | 4 1 hole  $\varnothing$  2.9 mm  $\pm$  0.05 / 0.11 in.  $\pm$  0.002, for aligning the printed circuit board (with cut-out marked **a**)

- | 5 1 elongated hole for aligning the printed circuit board (with cut-out marked **b**)
- | 6 4 holes  $\varnothing$  2.4 mm / 0.09 in. for clipping in adapter ZBZ01•

Dimensions An + 18.1 relate to the  $\varnothing$  2.4 mm  $\pm$  0.05 / 0.09 in.  $\pm$  0.002 holes for centring adapter ZBZ01•.

### Electrical Composition Corresponding to Code C4



### Electrical Composition Corresponding to Code C5



### Electrical Composition Corresponding to Code C6

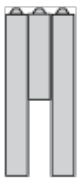

### Electrical Composition Corresponding to Code C7

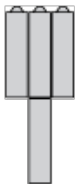

### Electrical Composition Corresponding to Code C8



### Electrical Composition Corresponding to Code C3



### Electrical Composition Corresponding to Codes C9, C11, SF1 and SR1



### Legend

Single contact



Double contact



Light block



Possible location



### Sequence of Contacts Fitted to 2-position Selector Switch Body

#### Position 315°



<b>Push</b>	Position	Top			
		Bottom			
	Location		Left	Centre	Right
	State		0	0	0
<b>Contacts</b>	N/O	open	open	open	
	N/C	closed	closed	closed	

#### Position 45°



<b>Push</b>	Position	Top			
		Bottom			
	Location		Left	Centre	Right
	State		1	1	1
<b>Contacts</b>	N/O		closed	closed	closed
	N/C		open	open	open