

**Characteristics / Ordering Code**

Pilot operated check valves series ZRE are designed for maximum flow rates and long life time.

The valves are typically used in combination with spool type directional control valves to ensure nearly leak free positioning of the actuator.

The inlet flow is free while the outlet flow is blocked. Pressure in the inlet line opens the check valve and allows free outlet flow.

**Features**

- High flow capacity
- High life time
- Check function in A, B or A + B
- ZRE01 - NG06 (CETOP 03)
- ZRE02 - NG10 (CETOP 05)



ZRE-B01

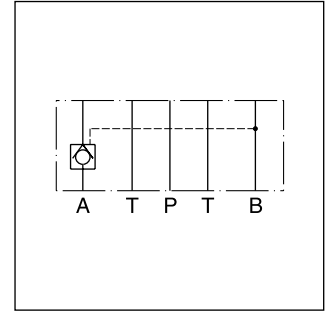

ZRE-A02

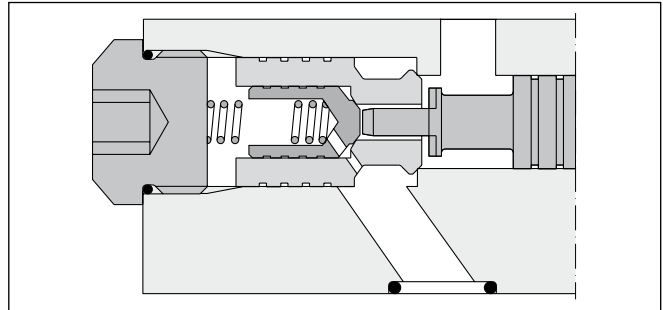

ZRE-A02

**Ordering code**

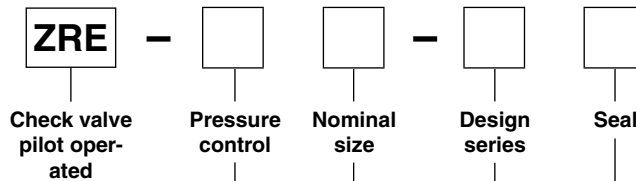

Check valve pilot operated

Pressure control

Nominal size

Design series

Seal

Code	Pressure control
A	Blocked in A
B	Blocked in B
AB	Blocked in A and B

Code	Nominal size
01	NG06
02	NG10

Code	Seal
1	NBR
5	FPM

Code	Design series
D	NG06
E	NG10

Ordering code details see end of chapter.

**Technical data**

General			
Size		NG06	NG10
Mounting interface		DIN 24340 A6 ISO 4401 NFPA D03	DIN 24340 A10 ISO 4401 NFPA D05
		CETOP RP 121	
Mounting position		unrestricted	
Ambient temperature	[°C]	-20...+50	
MTTF <sub>D</sub> value	[years]	150	
Weight	[kg]	1.2	3.1
Hydraulic			
Max. operating pressure	[bar]	up to 350	315
Nominal flow	[l/min]	60	120
Opening ratio (pilot cone / main cone)		1:6	1:6
Opening pressure	[bar]	1.2	2.0
Leakage		on request	
Fluid		Hydraulic oil according to DIN 51524...51525	
Fluid temperature	[°C]	-20...+80	
Viscosity permitted	[cSt]/[mm <sup>2</sup> /s]	10...650	
Viscosity recommended	[cSt]/[mm <sup>2</sup> /s]	30	
Filtration		ISO 4406 (1999); 18/16/13	

ZRE UK.INDD CM 30.08.13

**p/Q performance curves**

**ZRE\*01**

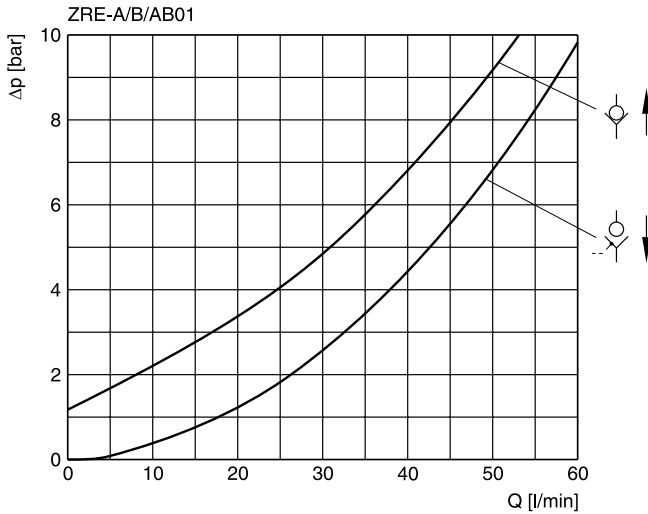

**ZRE\*02**

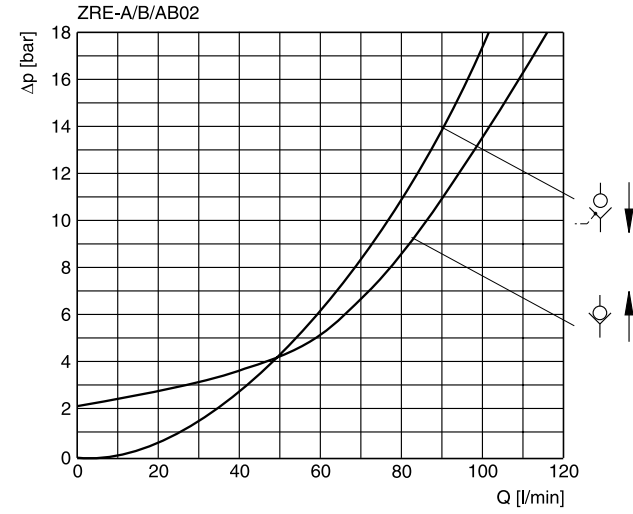

All characteristic curves measured with HLP46 at 50 °C.

**Dimensions**

**ZRE\*01**

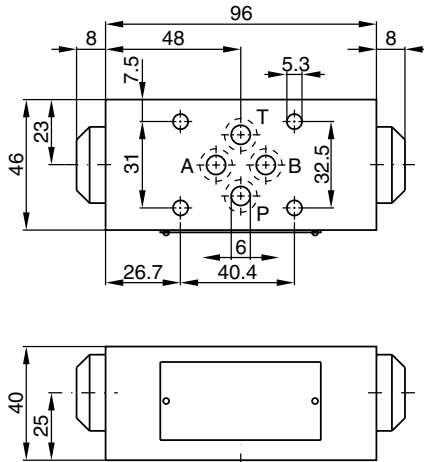

Seal kit	
Seal	Order code
1	098-91088-0
5	098-91089-0

**ZRE\*02**

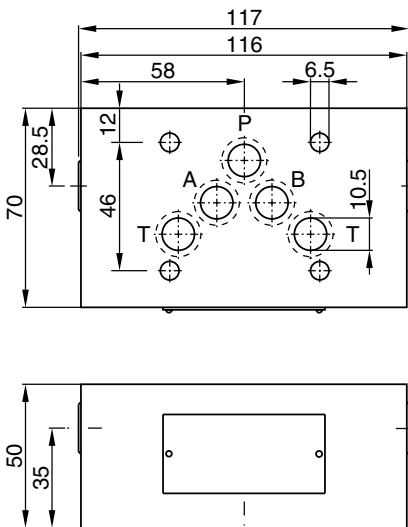

Seal kit	
Seal	Order code
1	098-91090-0
5	098-91091-0

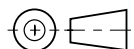

**ZRE\*01**

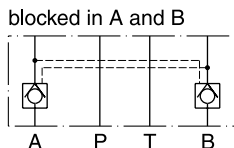

Series  
 ZRE-AB01-D1

Order No.  
 098-91020-0

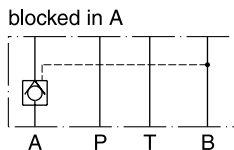

Series  
 ZRE-A01-D1

Order No.  
 098-91018-0

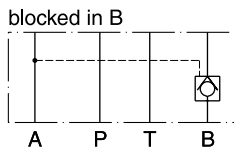

Series  
 ZRE-B01-D1

Order No.  
 098-91019-0

**ZRE\*02**

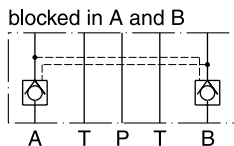

Series  
 ZRE-AB02-E1

Order No.  
 098-91300-0

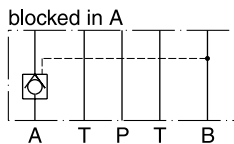

Series  
 ZRE-A02-E1

Order No.  
 098-91298-0

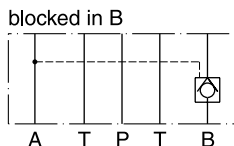

Series  
 ZRE-B02-E1

Order No.  
 098-91304-0

7