



The world's first Flexible PIFA antenna for Wi-Fi MIMO applications (patent pending). The FlexPIFA MIMO is specifically designed for 802.11 a/b/g/n as well as 802.11ac Wi-Fi modules that use MIMO or Wi-Fi Diversity. The flexible PIFA design provides for consistent performance across a broad array of enclosures and enables adhering the antenna to flat and curved surfaces. The FlexPIFA MIMO drastically simplifies the size, cost, and technical requirements for implementing the two antennas required for 802.11 MIMO radio applications; the proper orientation and spacing between the two integrated antenna elements is already optimized for MIMO radio performance, giving you the best possible range and throughput.

FEATURES AND BENEFITS

- Two Integrated 2.4/5 GHz dual band elements specifically designed for 802.11 MIMO applications
- Laird Connectivity's patented flexible PIFA antenna structure allows for use on flat and curved surfaces
- Compact design versus the complexity of two separate antennas
- Low ECC performance for best in class throughput and range performance
- Simple installation with optimized antenna orientation and spacing

ELECTRICAL SPECIFICATIONS		
Operating Frequency (MHz)	2400 - 2480	4900 - 5900
Peak Gain – Typ (dBi)	1.7	2.5
Peak Gain – Max (dBi)	2.0	3
VSWR Port 1 (Typ)	<2.3:1	<2.8:1
VSWR Port 2 (Typ)	<2.3:1	<2.8:1
VSWR (Max)	<2.5:1	<3.0:1
Isolation, dB (Typ)	>19	>19
Max Gain ±30 above Horizon (dBi)	N/A	2.2
Nominal Impedance (Ohms)	50	
Max Power @ 25°C (Watts)	10	
Polarization	Linear H/V for each radiator	
Azimuth Beam Width	Omnidirectional	

MECHANICAL SPECIFICATIONS	
Dimensions – mm (in.)	33.25 x 33.25 x 4.44 (1.309 x 1.309 x .170)
Weight – g (oz.)	2.5 (0.088)

ENVIRONMENTAL SPECIFICATIONS	
Operating Temperature	-40°C to +85°C (-40°F to +185°F)
Storage Temperature	-40°C to +85°C (-40°F to +185°F)
Material Substance Compliance	RoHS Compliant

CONFIGURATION

PART NUMBER	CABLE LENGTH	CONNECTOR
EFD2455A3S-10MHF1	100 mm	U.FL or IPEX MHF1
EFD2455A3S-30MHF1	300 mm	U.FL or IPEX MHF1
EFD2455A3S-10MH4L	100 mm	IPEX MHF4L

Note: Specifications are based on the 100mm cable length, standard antenna version with MHF1 / U.FL connector. Varying the cable length or type or connector will cause variations in these antenna specifications.

MECHANICAL DRAWING

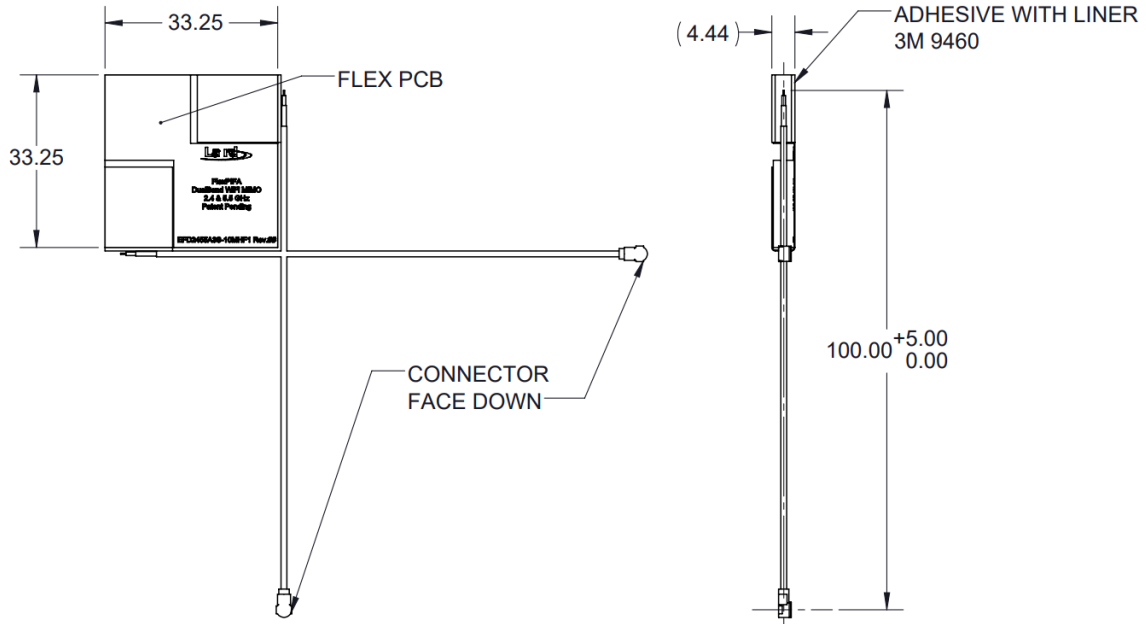

RADIATION PATTERNS

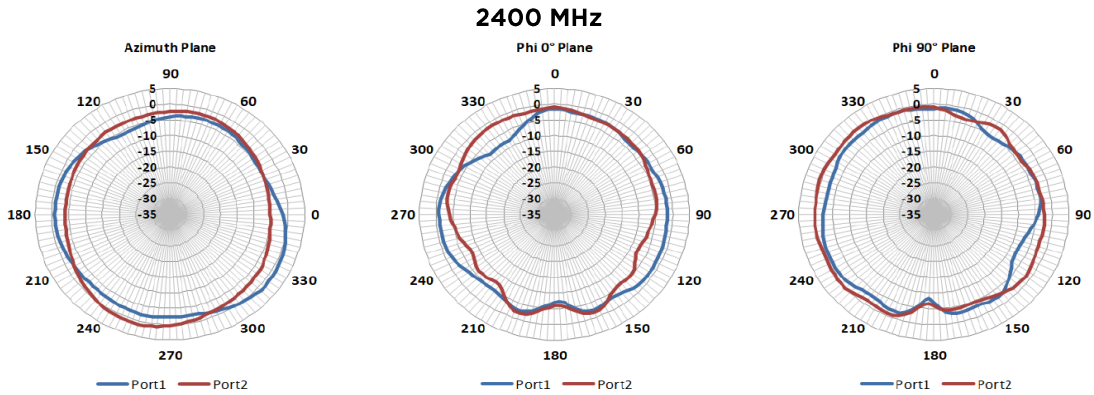

2440 MHz

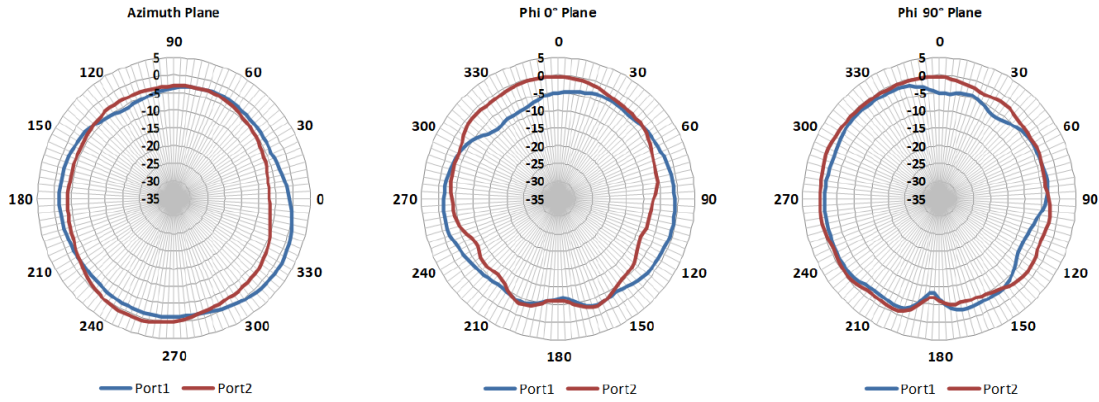

RADIATION PATTERNS (CONTINUED)

2480 MHz

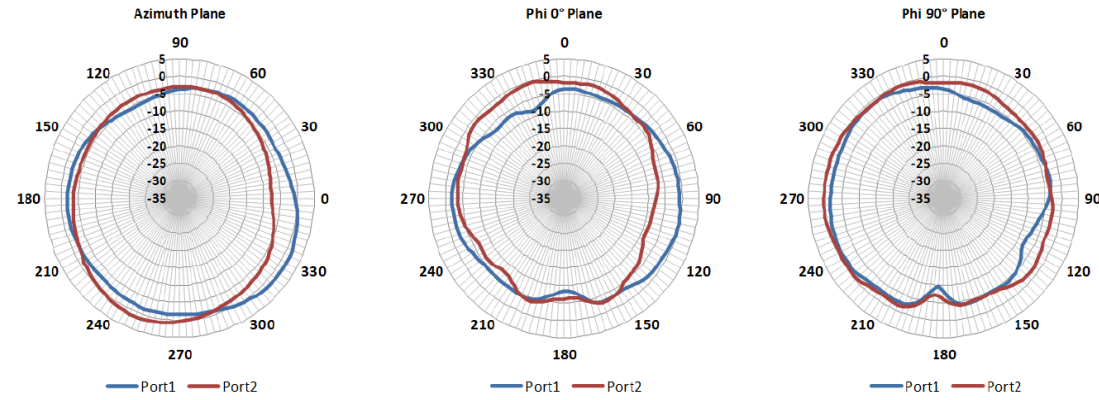

4900 MHz

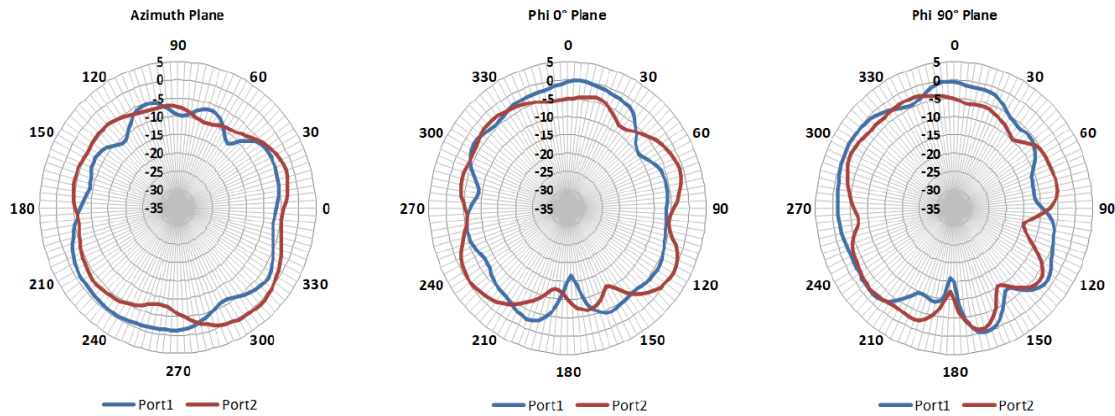

5150 MHz

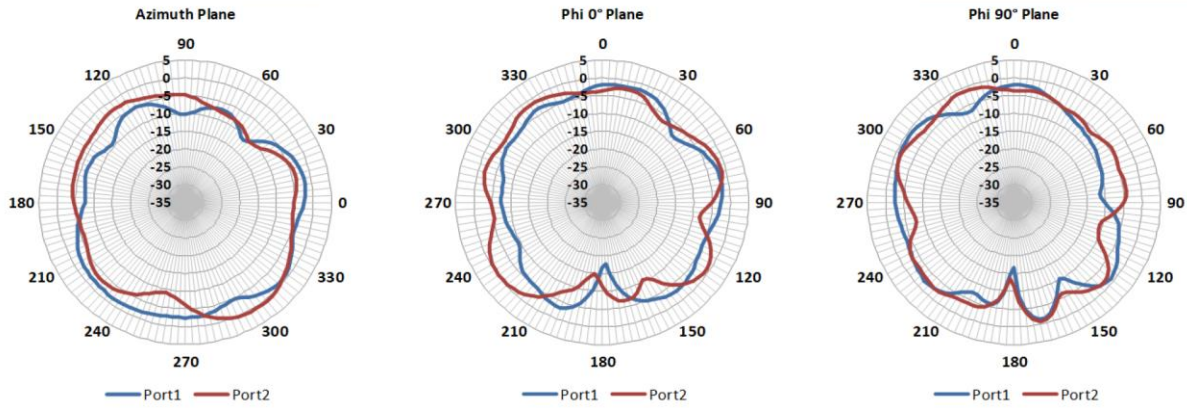

RADIATION PATTERNS (CONTINUED)

5500 MHz

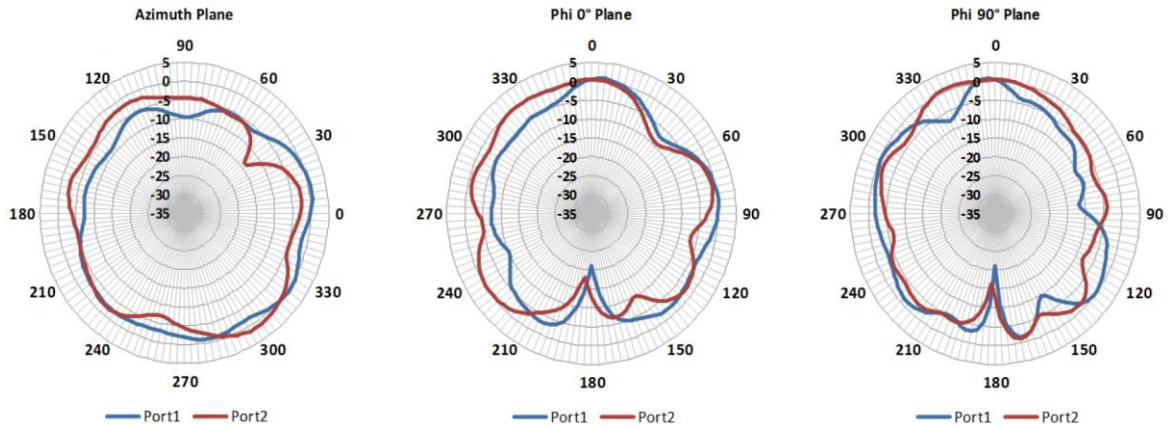

5800 MHz

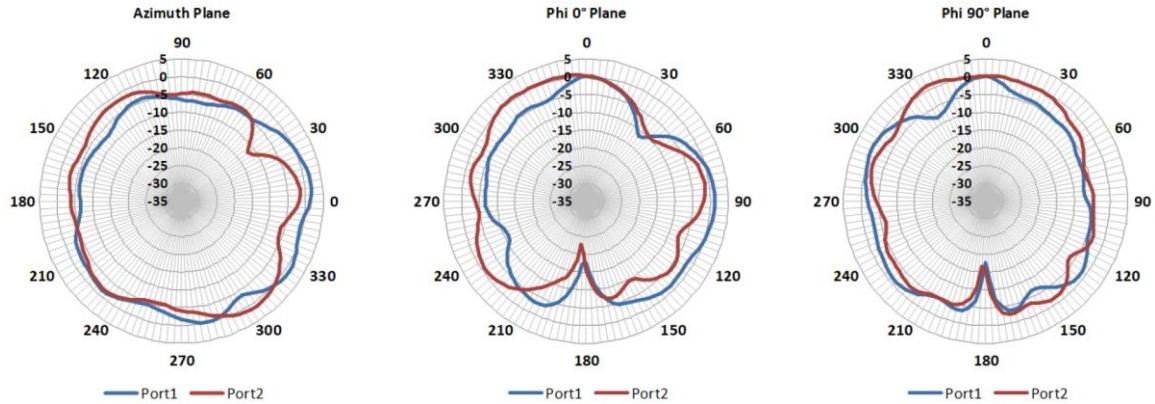

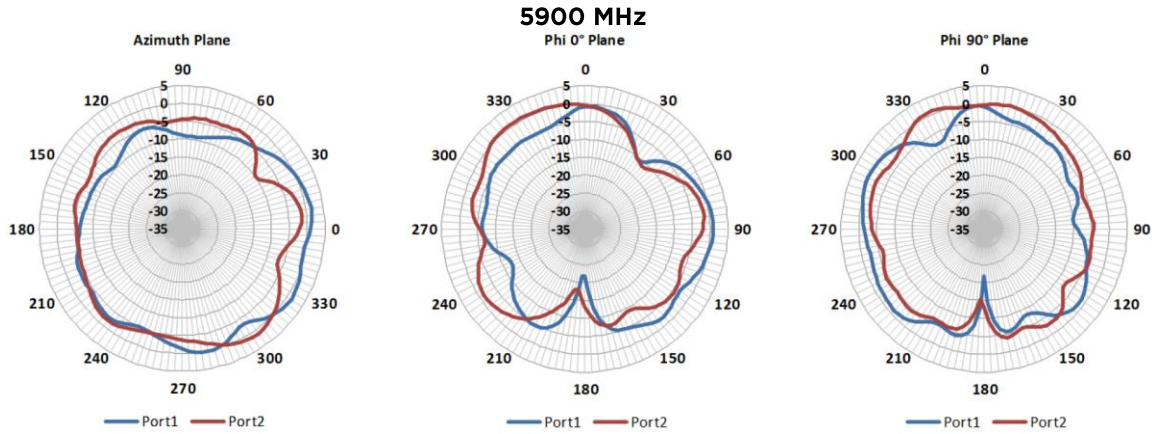

Measurement Coordinate System

The following image/graphic represents the measurement coordinate system used when capturing the radiation patterns shown;

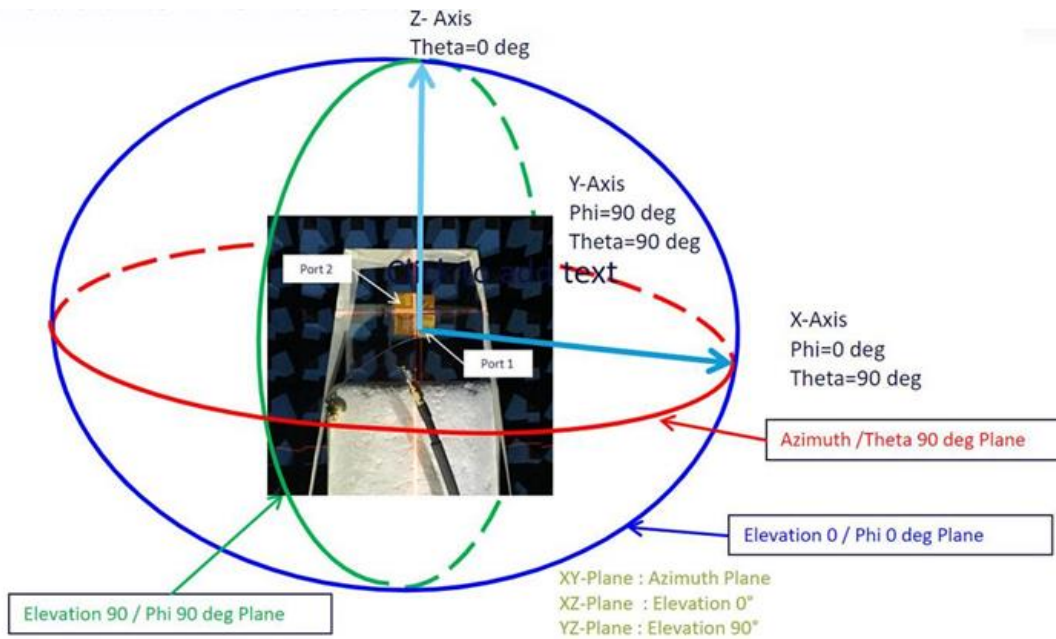

PRODUCT PLACEMENT

Initial Placement

The FlexPIFA is designed to attach to dielectric surfaces encountered in plastic packaging of wireless communications devices. The nominal attachment surface used in its design and characterization is a 100 mm x 100 mm, 1.5-millimeter thick, Polycarbonate sheet. The antenna should be centered within the lateral plane of the dielectric sheet as shown in Figure 1.

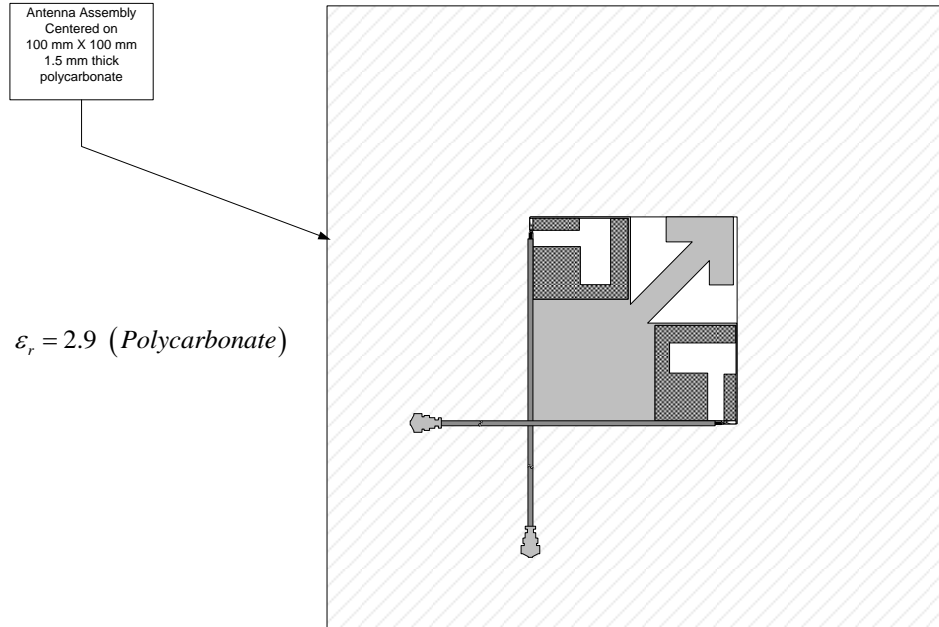

Figure 1: Nominal placement of FlexPIFA MIMO Antenna array on 100 mm X 100 mm, 1.5 mm thick, polycarbonate sheet

Co-Planar Ground Plane Edge Coupling and Clearance

The recommended minimum spacing between the ground plane and the antenna array is 5 millimeters to minimize any performance degradations to the reflection parameters (VSWR, Return Loss), spatially averaged gain (efficiency), or peak spatial gain (directivity). The drawings presented in Figure 2 and Figure 3 represent the proper clearance between the antenna array and a co-planar and edge-coupled ground plane.

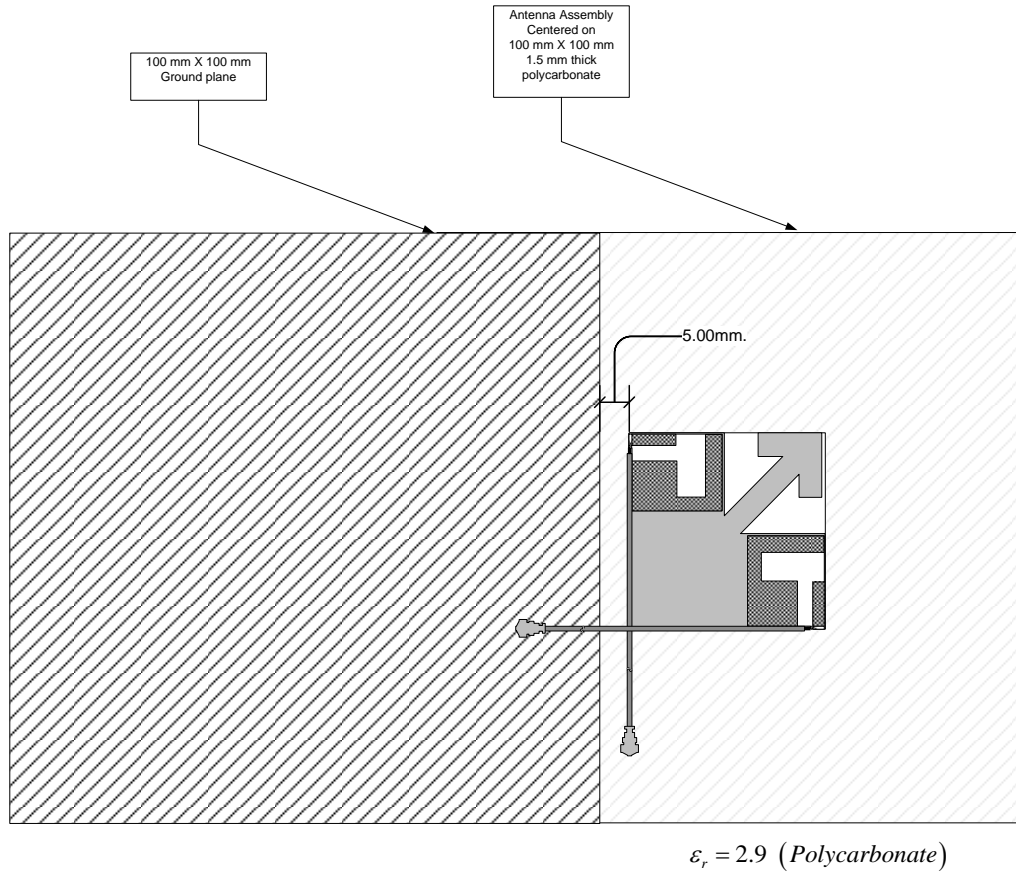

Figure 2: Minimum clearance between co-planar edge-coupled ground planes for one placement instance

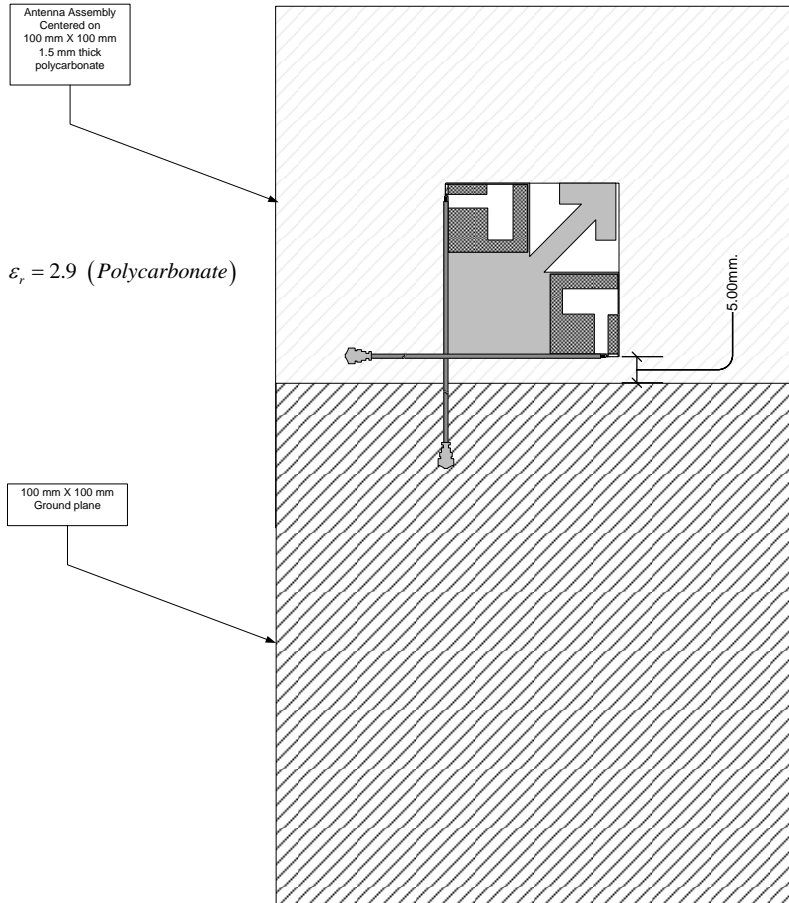

Figure 3: Minimum clearance between co-planar edge-coupled ground planes for another placement instance

Parallel Ground Plane Placement and Clearance

We recommend that a parallel ground plane not be placed either above or below the antenna array because it degrades the designed peak gain. Increased peak gain can have implications in consequent radio certifications since a maximum declared peak gain is specified as a test condition during the certification testing. Antenna with peak gain beyond the declared value for the certification can cause the device to be non-compliant.

Parallel Dielectric Sheet Loading and Clearance

A parallel dielectric sheet can be placed over the antenna with a minimum of ten millimeters as shown in [Figure 4: Minimum clearance of dielectric sheet loading on top of the antenna array.](#)

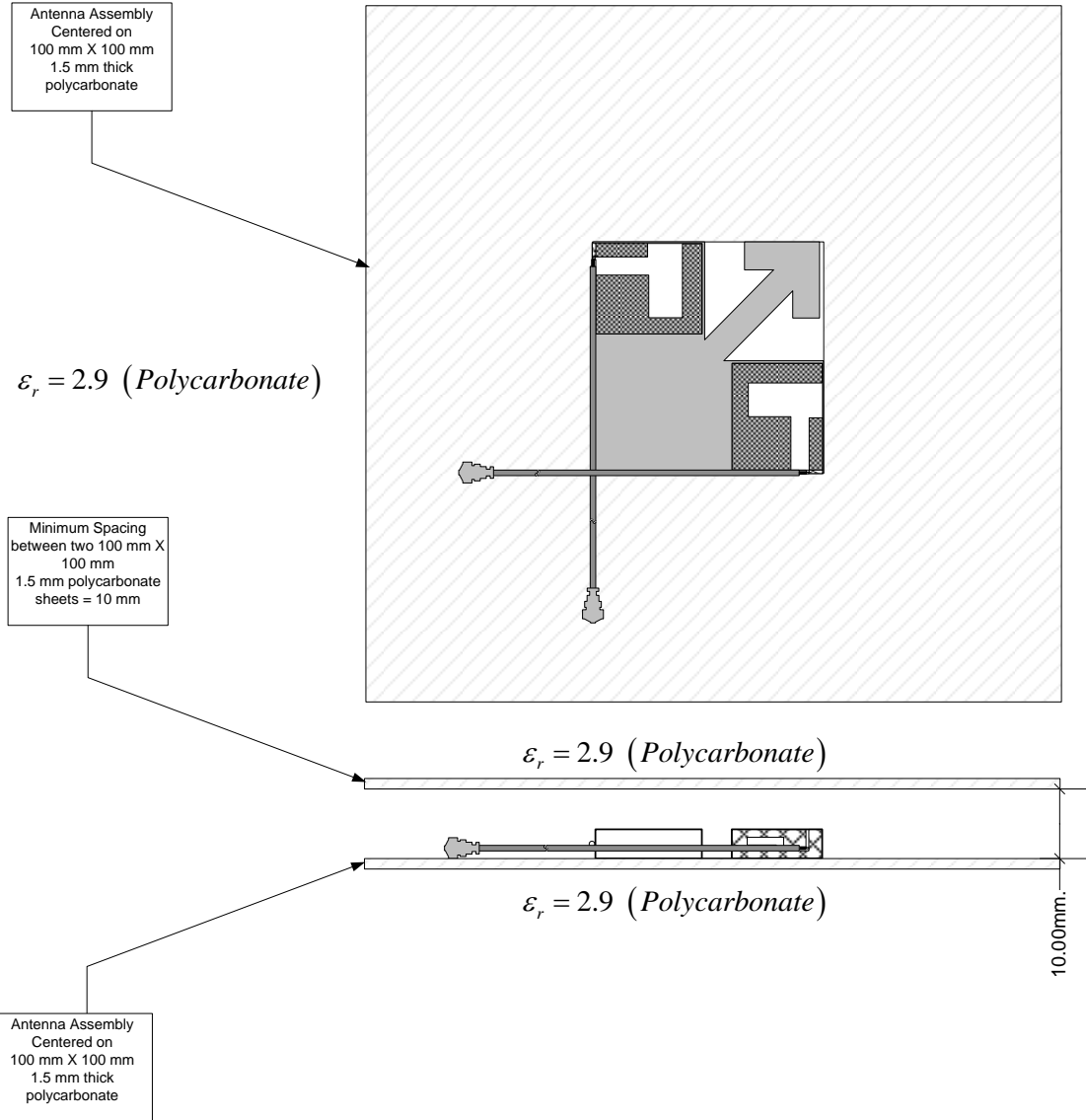

Figure 4: Minimum clearance of dielectric sheet loading on top of the antenna array

Operation on Dielectric Curved Surfaces

One of the benefits of the flexible nature of antenna array is that it can be placed on curved surfaces. The array was tested on both convex and concave curved surfaces with radii of curvature of 37.5 millimeters and 33 millimeters, respectively. The testing was performed using a 75-millimeter nominal OD (outside diameter), PVC (Polyvinyl chloride) pipe with an average thickness of 2.5 millimeters.

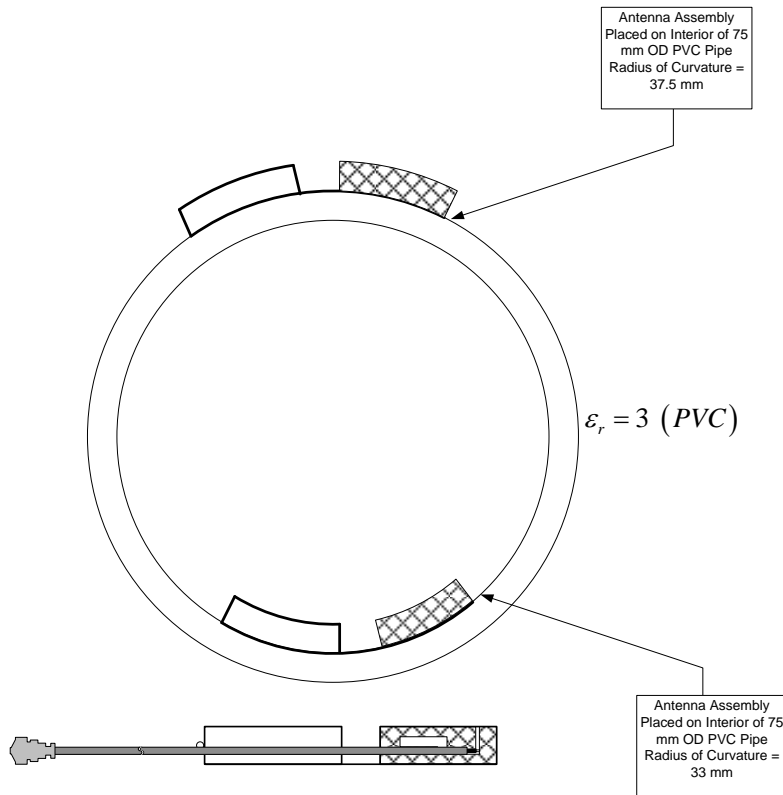

Figure 5: Operation of the antenna array on a dielectric curved surface

Summary Recommendations

We recommend the following:

- Initial placement: Place on any dielectric sheet or surface
 - Nominal material thickness – 1.5 mm
 - Relative dielectric constant – Approximately 3
- Clearance to Co-planar, edge-coupled ground planes – 5 mm (minimum)
- Clearance to Parallel Ground Planes – Not recommended
- Clearance to Parallel Dielectric Sheet above antenna array – 10 mm
- Operation on curved surfaces:
 - Convex radius of curvature – 37.5 mm (typical)
 - Concave radius of curvature – 33 mm (typical)