

DIN rail perforated - NS 35/ 7,5 PERF 955MM - 1207653

Please be informed that the data shown in this PDF Document is generated from our Online Catalog. Please find the complete data in the user's documentation. Our General Terms of Use for Downloads are valid (<http://phoenixcontact.com/download>)



DIN rail perforated, Standard profile, width: 35 mm, height: 7.5 mm, acc. to EN 60715, material: Steel, galvanized, passivated with a thick layer, length: 955 mm, color: silver

RoHS

Key Commercial Data

Packing unit	10 pc
Minimum order quantity	10 pc
GTIN	 4 017918 932633
GTIN	4017918932633
Weight per Piece (excluding packing)	305.000 g
Custom tariff number	72166190
Country of origin	Germany

Technical data

Dimensions

Height	7.5 mm
Length	955 mm
Width	35 mm
Hole width	15.00 mm
Hole height	6.20 mm
Drill hole spacing	25.00 mm

General

Material	Steel
Coating	galvanized, passivated with a thick layer
Color	silver

Standards and Regulations

Test standard	acc. to EN 60715
---------------	------------------

DIN rail perforated - NS 35/ 7,5 PERF 955MM - 1207653

Technical data

Standards and Regulations

Connection in acc. with standard	IEC / EN
----------------------------------	----------

Drawings

Dimensional drawing

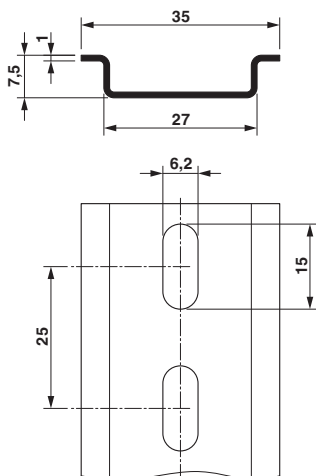

Classifications

eCl@ss

eCl@ss 4.0	23150301
eCl@ss 4.1	23150301
eCl@ss 5.0	27141143
eCl@ss 5.1	27141100
eCl@ss 6.0	27400600
eCl@ss 7.0	27400602
eCl@ss 8.0	27400602
eCl@ss 9.0	27400602

ETIM

ETIM 2.0	EC001285
ETIM 3.0	EC001285
ETIM 4.0	EC000212
ETIM 5.0	EC000212
ETIM 6.0	EC001285
ETIM 7.0	EC001285

UNSPSC

UNSPSC 6.01	30212109
UNSPSC 7.0901	39121708

DIN rail perforated - NS 35/ 7,5 PERF 955MM - 1207653

Classifications

UNSPSC

UNSPSC 11	39121708
UNSPSC 12.01	39121708
UNSPSC 13.2	39121708