

Features

- RS PRO BCF Series couplings have two patchlock socket head cap screws each end.
- Metric Four Beam Coupling clamping style
- Torsionally rigid one-piece construction
- Made from Stainless Steel 303 (SS)
- Bore tolerance +0.025 mm / -0.000 mm.
- Recommended shaft tolerance +0.000 mm / -0.013 mm.
- Our four beam couplings are more flexible with lower bearing loads.

RS PRO Flexible Coupling

RS-Stock Number: 0764279



RS PRO is the own brand of RS. The RS PRO Seal of Approval is your assurance of professional quality, a guarantee that every part is rigorously tested, inspected, and audited against demanding standards. Making RS PRO the Smart Choice for our customers.

Product Description

RS PRO flexible couplings made from Stainless Steel 303 (SS)) are used where a degree of motion is needed between the shafts. These couplings can improve the performance of a machine and reduce wear and tear. They are easy to install and have a long-life span. The types of couplings that sit within the flexible couplings area are gear couplings, and universal joint couplings. Each coupling is manufactured as one piece, thereby eliminating mechanical joints and possible failure points. Type BCF couplings have two patchlock socket head cap screws each end.

General Specifications

Material	Stainless Steel 303 (SS)
Coupling Type	Beam Coupling
Series	BCF
Fastening Type	Clamping

Mechanical Specifications

Bore 1	5 mm
Bore 2	5 mm
Outside Diameter	20 mm
Length	28 mm
Cap Screw	M3

Product Details

RS PRO Metric Four Beam Coupling – Clamp Style

Material	Stainless Steel 303 (SS)
Coupling Type	Beam Coupling
Series	BCF
Fastening Type	Clamping

Type BCF couplings have two patchlock socket head cap screws each end.

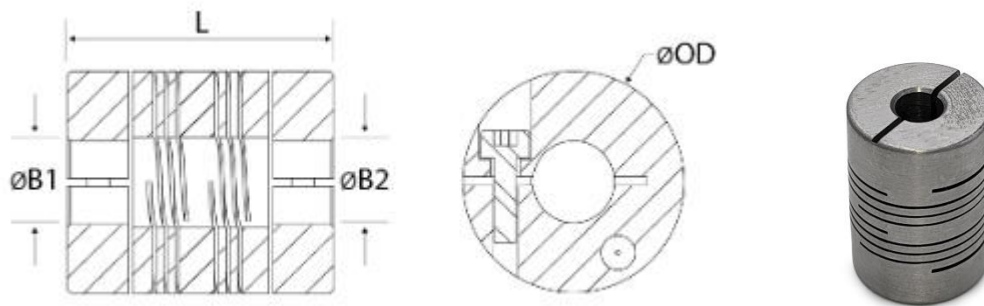

Stock No.	Bore Ø B1	Bore Ø B2	Outer Ø OD	Length L	Cap Screw
BCF15-5-5-SS	5 mm	5 mm	15 mm	22 mm	M2
BCF20-5-5-SS	5 mm	5 mm	20 mm	28 mm	M3
132163	6 mm	6 mm	20 mm	28 mm	M3
BCF25-6-6-SS	6 mm	6 mm	25 mm	30 mm	M3
BCF25-8-8-SS	8 mm	8 mm	25 mm	30 mm	M3