

# EMS AV2

## Energy management system



### Description

EMS is an all-in-one smart meter, gateway, web-server and controller. It is an energy analyser that can monitor one three phase load (or 3 single-phase loads), expandable to 10 three-phase loads via ESY bus add-ons.

EMS is a gateway that supports several communication protocols including Modbus (TCP/IP and RTU), BACnet IP, FTP, FTPS, SFTP, Rest-API and MQTT which allow for rapid integration with third-party software and any other device connected to the network (e.g., building energy management systems and inverters or charging stations).

EMS is a stand-alone controller: with two Ethernet ports, RS485 ports and Wi-Fi communication for a easy and simple programming via smart-phone; energy data readings can be pushed to external servers/Cloud and can be stored in the internal memory of the device.

By combining accurate metering, a powerful Linux powered CPU in a small case, EMS is really a complete Energy Management System in a box.

### Benefits

- **All-in-one Energy Management System:** fully integrated smart meter, data logger, gateway, web server and controller.
- **High measurement accuracy.**
- **User-friendly installation and set up:** the start-up and each function can be managed and configured by a unique web app (compatible with PC and smart-phones).
- **Real-time data acquisition.**
- **Accurate and reliable 3-phase energy measurement for consumption and feed-in.**
- **Direct connection** of up to 65 A.
- **Scalability:** it is easy to scale up the system thanks to additional ESY accessories.
- **Generic MQTT compatibility:** EMS can send real-time data and data can be stored in the EMS database to a generic MQTT broker. Moreover, EMS has been validated for working with Azure IoT and is compatible with Amazon AWS IoT.
- **Powered by MAIA Cloud:** secure and reliable system for remotely managing, setting and operating EMS units Worldwide.
- **Optimised user interface and data management.** Improved user experience for fast commissioning and easy daily operation thanks to a multi-user system.
- **Over-the-Air (OTA) Updates.** Seamlessly update the firmware of multiple deployed devices remotely via the MAIA Cloud portal, ensuring continuous improvement and maintenance without on-site intervention.
- **Quick configuration.** The configuration wizard that runs when the system is started for the first time allows you to put the unit into operation without errors and in few seconds.
- **Cybersecurity (IoT Security Rating):** Security Capabilities Verified by UL to Level SILVER for EMS (Security Enhancement).
- **Optional Open-EM system:** for allowing third party software modules to be embedded into EMS so to build custom solutions for specific applications.

## References

### How to order

 **EMS10 AV2**

Enter the code option instead of

Code	Options	Description
<b>EMS10 AV2</b>	-	-
<input type="checkbox"/>	<b>S1</b>	Modbus RTU slave + one digital input
<input type="checkbox"/>	<b>O1</b>	One digital input + one digital output
<input type="checkbox"/>	<b>X</b>	-

### MAIA Cloud licences

Information	Description	Document
UWP-LICENCE-M01B	MAIA PLUS LICENCE-12 MONTHS VPN	Licence Code EIM pdf
UWP-LICENCE-M02B	MAIA PLUS LICENCE-24 MONTHS VPN	
UWP-LICENCE-M04B	MAIA PLUS LICENCE-48 MONTHS VPN	
UWP-LICENCE-M05B	MAIA PLUS LICENCE-60 MONTHS VPN	
UWP-LICENCE-M25B	MAIA PLUS LICENCE-300 MONTHS VPN	
UWP-LICENCE-300C	MAIA PLUS LICENCE 300 CREDITS	

### Accessory modules

Module code	Connectable CT	Size
ESY3XMV	3 x 333 mV	1 DIN
ESY3XAV5	3 x 5 A	

 **Compatible devices**

Device	Instruction manual
UWP-MODEM-KIT-4G-E02	<a href="http://www.gavazziautomation.com/UWP-Modem-Kit-4G-E02.pdf">www.gavazziautomation.com/UWP-Modem-Kit-4G-E02.pdf</a>
UWP-ROUT-KIT-E01	<a href="http://www.gavazziautomation.com/UWP-ROUT-KIT-E01_A3.pdf">www.gavazziautomation.com/UWP-ROUT-KIT-E01_A3.pdf</a>
UWP-ROUT-KIT-US	<a href="http://www.gavazziautomation.com/UWP-ROUT-KIT-US_A3.pdf">www.gavazziautomation.com/UWP-ROUT-KIT-US_A3.pdf</a>

---

## Main metering functions

- Measure active, reactive and apparent energy
- Measure the main electrical variables
- Measure the load/analyser run hours
- Measure the total harmonic distortion (THD) of current and voltages
- Multi Load monitoring via plug'n play ESY BUS add-on modules

---

## Main IoT features

- Self power supply via voltage inputs
- Data transmission via Modbus BACnet, MQTT, FTP, SFTP, FTPS, Rest-API
- Embedded Wi-Fi for easy programming/data analysis
- Reliable data storage within the embedded database
- Data analytics organized in dashboards and widgets
- Display analytics based on the stored data via the embedded web server
- Embedded reporting system (scheduled or on-demand reports)
- Secure multi-user access either local (embedded web app) or remote (MAIA Cloud)
- Remote access and firmware update via MAIA Cloud (commissioning and troubleshooting)
- Two Ethernet ports (switch mode for easy cascading of connected devices)
- BTL certified
- IoT certification for Amazon AWS and Microsoft Azure
- Embedded display for diagnostics and variables

# Architecture

## Electrical connection

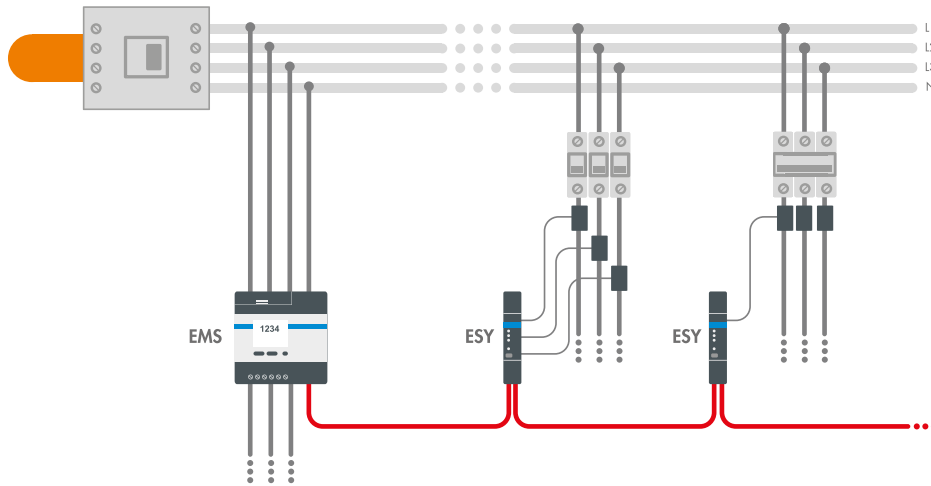



Connectivity

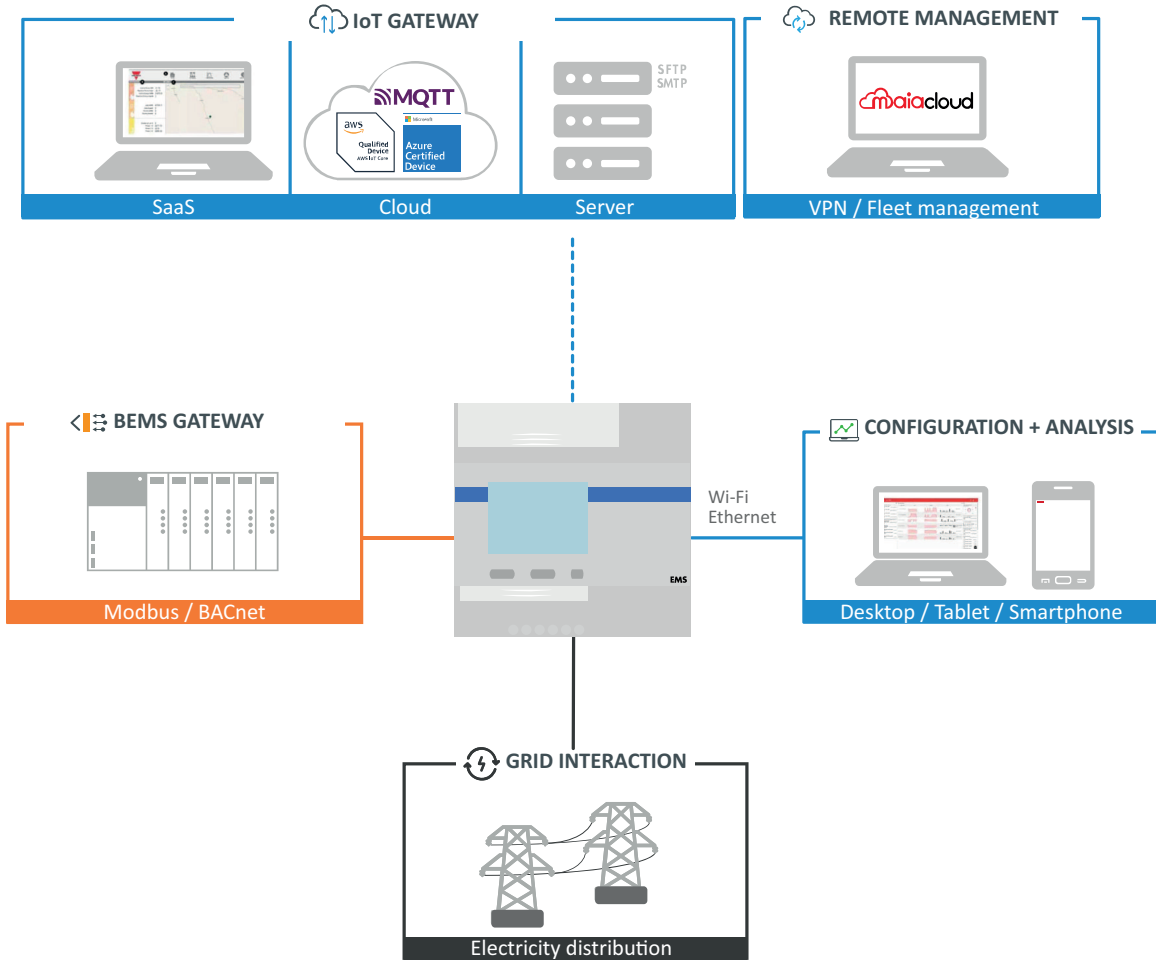

## Structure

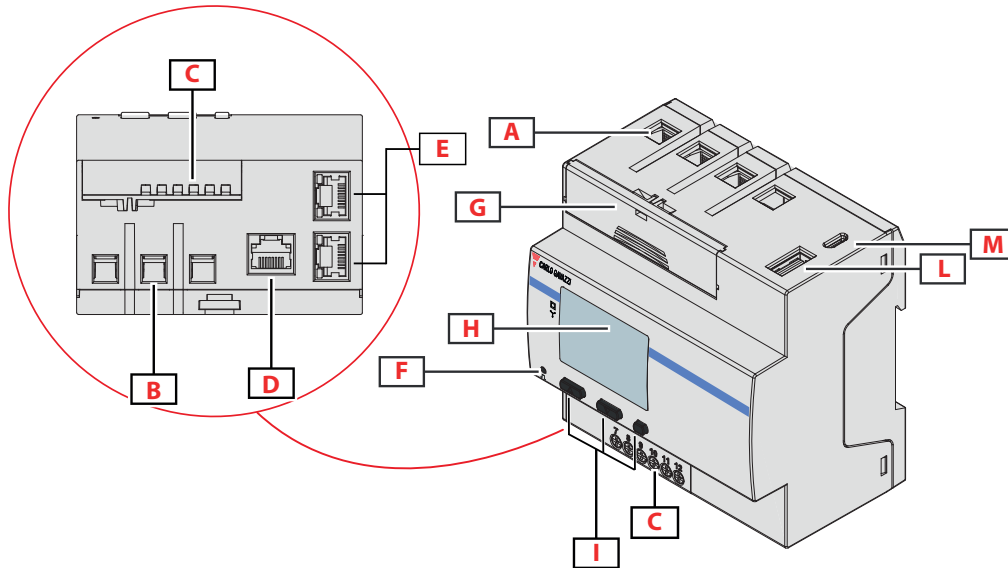

Area	Description
<b>A</b>	Voltage/Current inputs
<b>B</b>	Voltage/Current outputs
<b>C</b>	Sliding module (optional digital input and output or RS485 Modbus slave)
<b>D</b>	ESY Bus port (RJ45)
<b>E</b>	Dual Ethernet ports (internal switch)
<b>F</b>	LED
<b>G</b>	Seal housing
<b>H</b>	Display
<b>I</b>	Browsing and configuration buttons
<b>L</b>	USB type A port (4G modem connectivity)
<b>M</b>	Micro USB port (Point to point connection)

## Features

### General

<b>Material</b>	Housing: PBT Transparent cover: polycarbonate Compliant with UL and CE marks
<b>Dimensions</b>	5-DIN module
<b>Weight</b>	Approx. 500 g / 1.10 lb
<b>Protection degree</b>	Front: IP40 Screw terminals: IP20
<b>Terminals</b>	<b>Measurement inputs:</b> (Phase 1, 2, 3, N): 2.5 to 16 mm <sup>2</sup> / 8 to 13 AWG, 2.5 Nm / 22.12 lbin max. <b>Inputs, outputs and communication:</b> 0.2 to 1.5 mm <sup>2</sup> / 15 to 24 AWG, 0.4 Nm / 3.54 lbin max.
<b>Mounting</b>	DIN rail
<b>Overvoltage category</b>	III
<b>Pollution degree</b>	2
<b>Protective class</b>	Class II
<b>Rated impulse voltage</b>	4kV

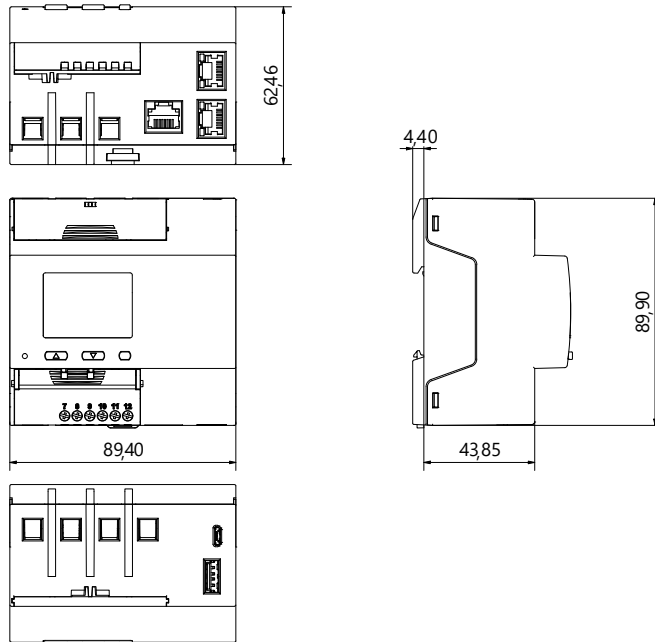

**Environmental**

<b>Operating temperature</b>	From -25 to +55 °C / from -13 to +131 °F
<b>Storage temperature</b>	From -30 to +70 °C / from -22 to 158 °F
<b>Altitude</b>	Max 3000 m / 9842.52 ft
<b>Electromechanical environmental condition</b>	E2
<b>Mechanical environmental condition</b>	M2





Note: R.H. < 90 % non-condensing @ 40 °C / 104 °F.

**Power Supply**

<b>Type</b>	Self power supply
<b>Frequency</b>	50/60 Hz
<b>Consumption</b>	10 W / 15 VA



**Compatibility and conformity**

<p><b>Directives</b></p>	<p><b>RED</b> 2014/53/EU  <b>RoHS</b> 2011/65/EU</p>
<p><b>Standards</b></p>	<p><b>Radio:</b> EN 300 328 V2.2.2  <b>EMC (Electro Magnetic Compatibility):</b> EN 301 489-1 V2.2.3, EN 301 489-17 V3.2.4, EN 62052-11.2021  <b>Safety:</b> EN IEC 61010-1  <b>Health:</b> EN 62311:2020  <b>Metrology:</b> EN IEC62053-21, EN IEC 62053-23  <b>FCC (USA) Radio Emission:</b> FCC CFR title 47 Part 15C, FCC CFR title 47 Part 2.1091  <b>IC (canadian) radio emission:</b> ISED RSS-247 Issue 3;                  ISED RSS-102 Issue 5</p>
<p><b>Approvals</b></p>	    

**Note:** the equipment must be installed and operated with minimum distance of 20 cm of the human body.

## Electrical specifications

Electrical system	
Managed electrical system	Single-phase (2-wire) Two-phase (3-wire) Three-phase with neutral (4-wire) Three-phase without neutral (3-wire) Wild-leg system (three-phase, four-wire Delta)

Voltage inputs	
Voltage connection	Direct
Rated voltage L-N	120 to 277 V AC
Rated voltage L-L	208 to 480 V AC
Voltage tolerance	+/- 15%
Overload	1.15 $U_n$ max
Frequency	From 45 to 65 Hz

Current inputs	
Current connection	Direct
Nominal current ( $I_n$ )	5 A
Minimum current ( $I_{min}$ )	0.25 A
Maximum current ( $I_{max}$ )	65 A
Start-up current ( $I_{start}$ )	20 mA
Overload	For 10 ms: 30 $I_{max}$ (1950 A)
Input impedance	< 3.4 VA
Utilization category	UC2
Crest factor	4 ( $I_{max}$ peak 92 A)

**Note:** EMS can be also installed in a wild-leg system (three phases, four-Delta wires), where one of the phase-neutral voltages is higher than the other two.



## Available measurements

Active energy	Unit	System	Phase
Imported (+) Total	kWh+	●	●
Imported (+) partial	kWh+	●	-
Exported (-) Total	kWh-	●	●
Exported (-) partial	kWh-	●	-
Imported (+) Total by tariff (t1, t2)	kWh+	●	-
Quadrant I, II, III, IV	kWh	●	-

Reactive energy	Unit	System	Phase
Imported (+) Total	kvarh+	●	●
Imported (+) partial	kvarh+	●	-
Exported (-) Total	kvarh-	●	●
Exported (-) partial	kvarh-	●	-
Quadrant I, II, III, IV	kvarh	●	-

Apparent energy	Unit	System	Phase
Total	kVAh	●	-
Partial	kVAh	●	-
Quadrant I, II, III, IV	kVAh	●	-

Run hour meter	Unit	System	Phase
Total (kWh+)	hh:mm	●	-
Partial (kWh+)	hh:mm	●	-
Total (kWh-)	hh:mm -	●	-
Partial (kWh-)	hh:mm -	●	-
Total ON time	hh:mm	●	-

Electrical variable	Unit	System	Phase
Voltage L-N	V	●	●
Voltage L-L	V	●	●
Current	A	●	●
Neutral current	A	●	-

Electrical variable	Unit	System	Phase
Active power	W	•	•
Apparent power	VA	•	•
Reactive power	Var	•	•
Power factor	PF	•	•
Frequency	Hz	•	-
THD current*	THD A %	-	•
THD voltage L-N*	THD L-N %	-	•
THD voltage L-L*	THD L-L %	-	•

\*Up to 31<sup>th</sup> harmonic

### Measurements

<b>Method</b>	TRMS measurements of distorted waveforms
---------------	--

### Measurement accuracy

Current	
From 2 A to 65 A	± 0.5% rdg
From 0.5 A to 2 A	± 1% rdg

Phase-phase voltage	
From $U_n$ min. -20% to $U_n$ max. +15%	± 0.5% rdg

Phase-neutral voltage	
From $U_n$ min. -20% to $U_n$ max. +15%	± 0.5% rdg

Active and apparent power	
From 0.25 A to 0.5 A (PF=1)	±1.5% rdg
From 0.5 A to 65 A (PF=1)	± 1% rdg
From 0.5 A to 1 A (PF=0.5 L - 1 - 0.8 C)	1.5% rdg
From 1 A to 65 A (PF=0.5 L - 1 - 0.8 C)	± 1% rdg
From 1.0 A to 65.0 A (PF=0.5 L - 1 - 0.8 C)	± 1% rdg
From 0.5 A to 1.0 A (PF=1)	± 1.5% rdg
Active energy	Class 1 EN IEC 62053-21

Reactive power	
From 1.0 A to 2.0 A (sinφ=0.5 L - 0.5 C)	± 2% rdg
From 0.5 A to 1.0 A (sinφ=1)	
From 2.0 A to 65.0 A (sinφ=0.5 L - 0.5 C)	± 2.5% rdg
From 1.0 A to 65.0 A (PF=1)	
Reactive energy	Class 2 EN IEC 62053-23

Frequency	
From 45 to 65 Hz	± 0.1% rdg

 Measurement resolution

Variable	Display resolution	Resolution by serial communication
Energy	0.001 kWh/kvarh/kVAh	
Single phase energy	N.A.	0.001 kWh
Power	0.001 kW/kvar/kVA	0.1 W/var/VA
Current	0.001 A	0.001 A
Voltage	0.1 V	
Frequency	N.A.	0.001 Hz
Power factor	0.01	0.001

## Digital outputs/inputs

### Digital inputs

<b>Connection type</b>	Screw terminals
<b>Number of inputs</b>	1
<b>Type</b>	Free contact
<b>Function</b>	Remote status Tariff management Partial meter start/pause Partial meter reset
<b>Features</b>	Open contact voltage: 5 V DC +/- 5% Closed contact voltage: 5 mA max Input impedance: 11.6 k $\Omega$ Open contact resistance: $\geq$ 25 k $\Omega$ Closed contact resistance: $\leq$ 840 $\Omega$ Maximum voltage applicable with no damages: 30 V AC
<b>Configuration parameters</b>	Input function
<b>Configuration mode</b>	Via web app

### Digital output

<b>Connection type</b>	Screw terminals
<b>Maximum number of outputs</b>	1
<b>Type</b>	Opto-mosfet
<b>Function</b>	Remote output, alarm
<b>Features</b>	$V_{ON}$ 2.5 V AC/DC, max 100 mA $V_{OFF}$ 42 V AC/DC
<b>Configuration parameters</b>	Output function (remote/alarm) Output normal status (NO or NC)
<b>Configuration mode</b>	Via web app



## Input and output insulation

Type	ESY port	Measurement inputs	Digital input	Digital out-puts	RS485 serial port	RJ45 ethernet port
<b>ESY port</b>	-	Basic	Basic	Basic	Basic	Basic
<b>Measurement inputs</b>	Basic	-	Double/Reinforced	Double/Reinforced	Double/Reinforced	Double/Reinforced
<b>Digital input</b>	Basic	Double/Reinforced	-	none	none	none
<b>Digital outputs</b>	Basic	Double/Reinforced	none	-	none	none
<b>RS485 serial port</b>	Basic	Double/Reinforced	none	none	-	none
<b>RJ45 ethernet port</b>	Basic	Double/Reinforced	none	none	none	-

According to EN IEC 61010-1. Overvoltage category III. Pollution degree 2.



## Display

<b>Type</b>	Graphical matrix display
<b>Refresh time</b>	500 ms
<b>Description</b>	128 x 96 backlit LCD
<b>Variable readout</b>	Instantaneous: 5+1 dgt or 5+3 dgt Energy: 8+3 dgt

## LED

<b>Function</b>	Red colour, pulse weight proportional to energy consumption
<b>Constant</b>	1000 pulse/kWh

## Ports

### Ethernet

<b>Number of ports</b>	2
<b>Standard</b>	ISO9847
<b>LAN configuration</b>	Static or DHCP IP Address; Net Mask; Default Gateway, DNS (primary, secondary)
<b>Protocols</b>	HTTP, HTTPS, FTP, FTPS, SFTP, Modbus TCP/IP, SMTP, NTP, Azure IoT Hub, AWS IoT, BACnet IP, Rest-API, Multicast DNS (mDNS), IEEE 802.1X
<b>Connection type</b>	2 x RJ45 connector (10 Base-T, 100 Base-TX) Maximum distance: 100 m Integrated switch function to connect another Ethernet device

### RS485

<b>Number of ports</b>	1
<b>Function</b>	Modbus slave port (for S1 versions)
<b>Connections</b>	2-wire. Max. distance: 600 m
<b>Protocol</b>	Modbus RTU
<b>Data format</b>	Selectable: 1 start bit, 7/8 data bit, no/odd/even/ parity, 1/2 stop bit
<b>Baud rate</b>	Selectable: from 2400 to 115200

### ESY bus

<b>Number of ports</b>	1
<b>Function</b>	Connection with ESY bus accessories
<b>Cable type</b>	Min. Cat. 5E, not crossed
<b>Cable length</b>	Max. 100 m
<b>Bus type</b>	Daisy chain (refer to standard Modbus RTU requirements)
<b>Number of ESY extension modules</b>	Max. 10 units

### USB micro bus

<b>Type</b>	High-speed USB 2.0 micro-B
<b>Mode</b>	Device
<b>Speed</b>	60 MB/s
<b>Function</b>	RNDIS (virtual Ethernet) Network access via IP: 192.168.254.254

### USB type A port

<b>Type</b>	High-speed 2.0 Type-A
<b>Mode</b>	Host
<b>Communication speed</b>	60 MB/s
<b>Function</b>	Modem communications
<b>Supported devices</b>	USB modem/router can be directly connected
<b>Supported file system</b>	USB mass storage not supported

### Wi-Fi

<b>Technology</b>	Wi-Fi IEEE 802.11 b/g/n 20/40 MHz
<b>Centre frequency range of operating channel</b>	2412 - 2472 MHz
<b>Maximum EIRP output power</b>	18.34 dBm
<b>Number of channels</b>	13
<b>Channel bandwidth</b>	20MHz, 40MHz
<b>Modulations</b>	DSSS, OFDM
<b>Number of Tx antennas</b>	1
<b>Type of antenna</b>	PCB antenna

<b>Antenna gain</b>	2.87dBi
<b>Installation category</b>	Mobile
<b>Connectivity</b>	2.4 GHz Spectrum Capabilities Wi-Fi CERTIFIED™ b Wi-Fi CERTIFIED™ g Wi-Fi CERTIFIED™ n
<b>Optimization</b>	WMM®
<b>Security</b>	Protected Management frames for SoftAP mode: WPA2™-Personal 2021-01  Protected Management frames Station mode: WPA2™-Enterprise 2018-04 WPA2™-Personal 2021-01 WPA3™-Enterprise 2020-02 WPA3™-Personal 2020-02 WPA™-Enterprise WPA™-Personal
<b>Modes</b>	SoftAP Station

# Connection Diagrams

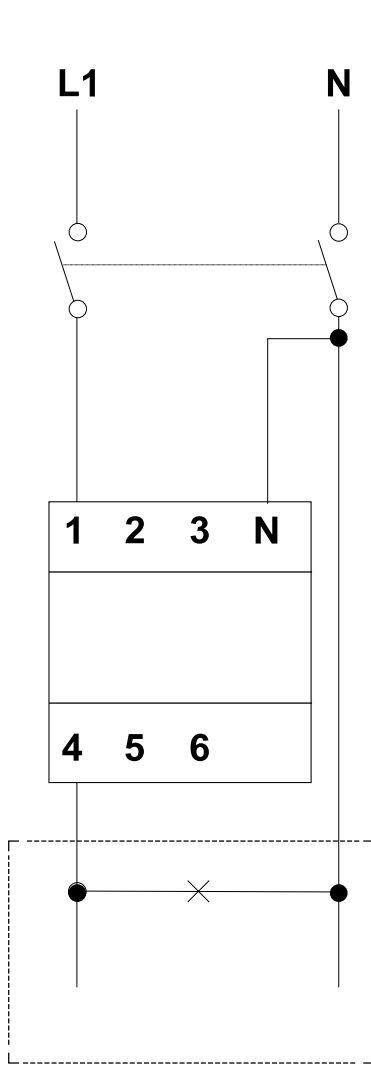

Single-phase system

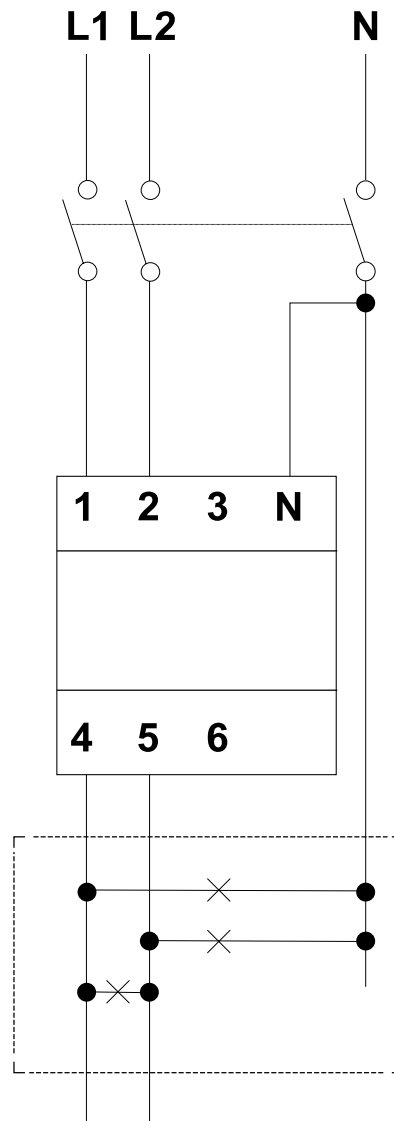

Bi-phase system

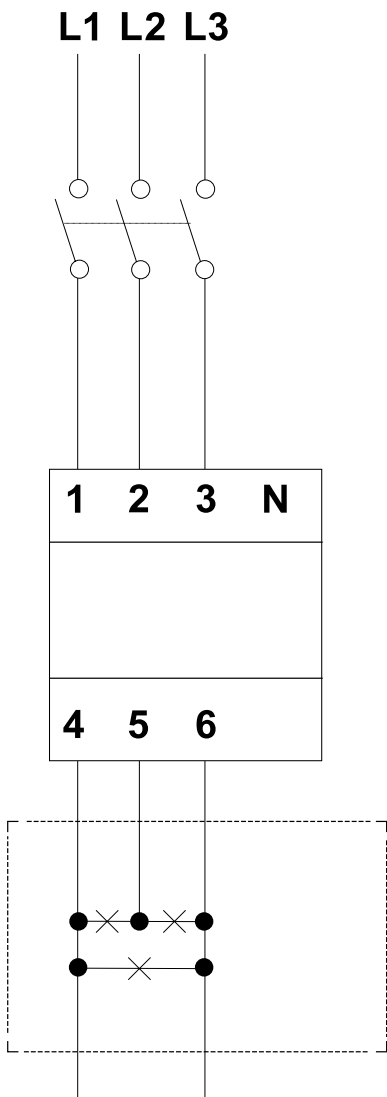

Three-phase without neutral (3-wire)

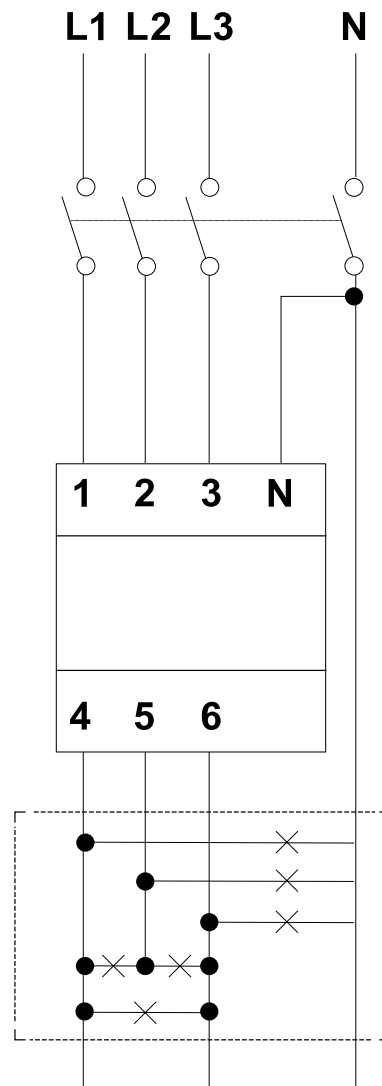

Three-phase with neutral (4-wire).

# Communication

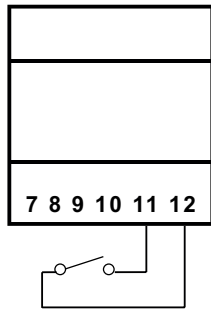

Digital\_Input

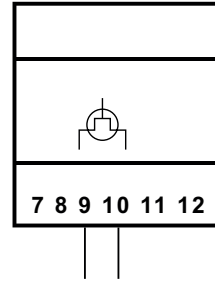

Digital\_Output

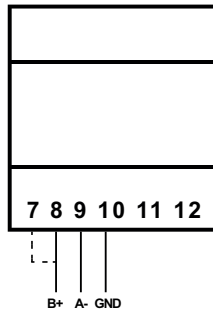

Modbus RTU: RS485 Slave (last device)

# Cybersecurity

## Introduction

Cybersecurity is the practice of protecting systems, networks, and programs from digital attacks. These cyberattacks are usually aimed at:

- accessing, changing, or destroying sensitive information;
- extorting money from users;
- interrupting normal business processes.

Implementing effective cybersecurity measures is particularly challenging today because there are more devices than people, and attackers are becoming more innovative.

For EMS AV2, the security capabilities have been verified by UL to Level SILVER.

The SILVER rating certifies the enhanced security capabilities of EMS AV2 regarding:

- Access Control
- Industry Privacy Best Practices
- Product Security Maintenance.

EMS has been developed following a Secure Software Development Life Cycle, where Security concerns are integral parts of each design and development stages, following Security by Design and Defense in Depth principles, with the goal of ensuring product security from the earliest design phases.

Security concerns are treated as first-class requirements throughout the lifecycle development. Rather than inspecting security issues after development, security is built into EMS from the earliest design stages through continuous automated testing and fast feedback loops. This approach, aligned with DevSecOps principles, ensures that security controls are validated incrementally as the product evolves, enabling early detection and fast resolution of potential vulnerabilities.



*Fig. 1 UL Verified Level*



*Fig. 2 IoT Security Rating Levels Guide*

 **Pillars**

EMS application processor provides strong embedded security capabilities through its security subsystems:

- Easy upgrade function. Web app notifies users about the availability of a new software and firmware version; the whole upgrade process is managed by the EMS AV2.
- Fleet management: One-click over-the-air (OTA) update of multiple devices simultaneously.
- Secure access: thanks to MAIA Cloud, you can access a EMS AV2 system through a secure VPN (virtual private network).
- Minimalist approach: EMS AV2 has been designed to include only the necessary sub-systems into a highly optimized linux core, so to avoid unnecessary risks due to attacks to unmonitored services.
- EdgeLock Secure Enclave as Root of Trust
- Hardware-Backed Cryptographic Key Management
- Authenticated Encryption (AEAD)
- True Random Number Generator (TRNG)
- Secure boot

## Network service ports

### Inbound communication

Port	Protocol	Service	Configurable	Default service
*80	TCP	HTTP	NO	Enable
443	TCP	HTTPS	NO	Enable
52325	TCP	SSH	NO	Enable
5353	UDP	mDNS	NO	Enable
67	UDP	DHCP server	NO	Enable
47808	UDP	BACnet gateway	YES	Disable
502	TCP	Modbus gateway	YES	Disable

\*Note: this port is redirected to 443

### Outbound communication

Port	Protocol	Service	Configurable	Default service
443	TCP	MAIA Cloud	NO	Enable
1194	UDP	MAIA Cloud (VPN)	NO	Enable
21	TCP	FTP	YES	Disable
22	TCP	SFTP	YES	Disable
990	TCP	FTPS	YES	Disable
53	UDP	DNS	NO	Enable
123	UDP	NTP	NO	Disable
25	TCP	SMTP	YES	Disable
587	TCP	SMTPS	YES	Disable
8883	TCP	MQTT	YES	Disable
8883	TCP	MQTTS	YES	Disable



COPYRIGHT ©2025

Content subject to change. Download the updated version:

[www.gavazziautomation.com](http://www.gavazziautomation.com)