

Megger[®]

LT300 Series Earth Loop Testers

USER MANUAL

**SAFETY WARNINGS**

- **Safety Warnings** and **Precautions** must be read and understood before the instrument is used. They **must** be observed during use.
- Continuity of protective conductors and earthed equipotential bonding of new or modified installations **must** be verified **before** carrying out an earth fault loop impedance or RCD tests.
- Do not leave the instrument connected to the mains supply when not in use.
- Circuit connections and exposed metalwork of an installation or equipment under test must not be touched.
- Ensure that hands remain behind guards of probes/clips when testing.
- The instrument should **not** be used if any part of it is damaged.
- Test leads, probes and crocodile clips must be in good order, clean and with no broken or cracked insulation.
- National Safety Authorities may recommend the use of fused test leads when measuring voltage on high-energy systems.
- The battery cover **must** be in place whilst conducting tests.
- Voltage indicator LED's cannot reveal a N-PE supply reversal.
- When making a 2 wire measurement with the 3 wire lead set, for safety reasons the black test lead should be connected together with the green test lead.

NOTE**THE INSTRUMENT MUST ONLY BE USED BY SUITABLY TRAINED AND COMPETENT PERSONS.**

Users of this equipment and/or their employers are reminded that Health and Safety Legislation requires them to carry out valid risk assessments of all electrical work so as to identify potential sources of electrical danger and risk of electrical injury such as inadvertent short circuits.

Some national safety authorities recommend fused leads for voltage measurement on high energy systems. If RCD or Loop tests are made it may cause the fuse to rupture, and so they must be used with caution on voltage testing.

CONTENTS

Safety warnings	3	Frequency Hz (LT320 and LT330)	16
Introduction	4	Phase sequence (LT320 and LT330)	16
General description	5	Test result storage (LT330 only)	17
Case contents	7	Replacing batteries and fuses	18
LCD display	6	Low battery warning symbol	18
Front panel	6	To replace batteries	18
Connection panel	7	Fuse blown indication	19
Lid open/closure	7	Auto power down	19
Preparations for use	8	Preventive maintenance	20
Batteries	8	Technical specification	20
Preliminary test lead check	8	Basic and service errors	22
General operating instructions	8	Accessories and equipment	23
Display warning symbols	8	Repair and Warranty	24
Setup procedure	9		
Reverse polarity or line/neutral swapping	9		
Test leads	9		
Test lead connection.	10		
LED indicators	10		
Loop testing	11		
Non-tripping loop test [No Trip]	11		
Hi current loop test [Hi]	11		
Phase-Earth loop impedance (not at a power socket):	12		
Phase-Neutral or Phase-Phase loop impedance	12		
Prospective fault current display [PFC]	12		
Error messages	12		
Possible sources of error	13		
maxZ (LT320 only)	14		
Deriving R1 + R2 (LT320 and LT330)	14		
Voltage measurement	15		
Phase to earth voltage measurement	15		
Phase to Phase voltage measurement (LT320 and LT330)	15		

Symbols used on the instrument are:



Caution: refer to accompanying notes



Equipment protected throughout by Double Insulation (Class II)



Equipment complies with current EU directives.



Equipment complies with 'C tick' requirements

INTRODUCTION

Thank you for purchasing the Megger Earth Loop Impedance Tester.

For your own safety and to get the maximum benefit from your instrument, please ensure that you read and understand the following safety warnings and instructions before attempting to use the instruments.

This user manual describes the operation and functions of the following LT300 series of Loop Impedance Testers:

LT310

LT320

LT330

GENERAL DESCRIPTION

The LT300 series test instruments have the following features

Feature	LT310	LT320	LT330
3 Phase safe	■	■	■
Large clear display	■	■	■
Backlight		■	■
Battery status indication	■	■	■
Auto power down	■	■	■
Fuse blown indication	■	■	■
L-N-E polarity indicators	■	■	■
Voltmeter range 500V	■	■	■
Frequency measurement		■	■
Phase rotation indicator		■	■
Reverse polarity operation (some models only)	■	■	■
Locking test button	■	■	■
3 wire no trip loop test	■	■	■
2 wire high loop test	■	■	■
Phase-Phase loop test		■	■
PFC display	■	■	■

CASE CONTENTS

Feature	LT310	LT320	LT330
Max Zs display		■	■
R1+R2/ZRef switch		■	■
Plug ended test lead	■	■	■
3 wire ended test lead probe/croc clip ended	■	■	■
Calibration certificate	■	■	■
IEC61010-1 300V CATIII	■	■	■
EN61557	■	■	■
Test result storage			■
USB download			■

Please complete the warranty card and return it to Megger as soon as possible to help us reduce any delays in supporting you should the need arise.

Carton contents LT310, LT320 and LT330

- 1 x LT300 series loop tester
- 1 x 3 wire test lead with prods with clips
- 1 x Plug ended test lead
- 8 x AA (LR6) batteries (fitted in instrument)
- 1 x Warranty card
- 1 x Certificate of test
- 1 x Calibration certificate
- 1 x CD containing user manual
- 1 x Quick start guide
- 1 x Download Manager CD (LT330 only)

LCD DISPLAY

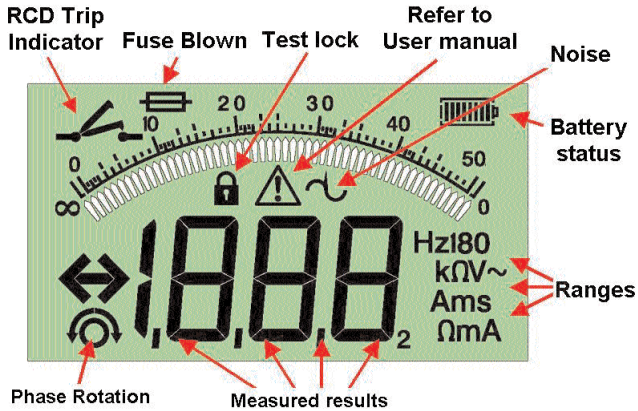

FRONT PANEL

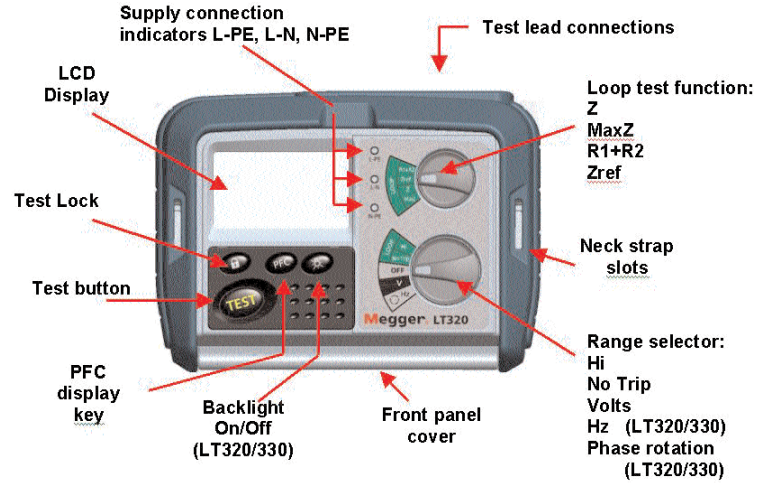

LT300 Series test lead connections

LT320 and LT320

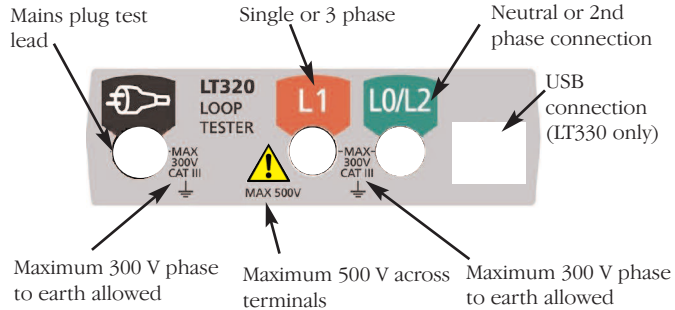

LT310

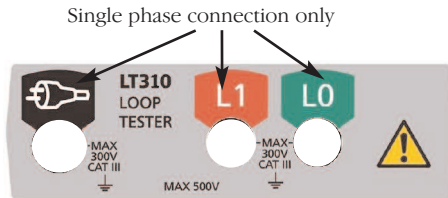

LT330 additional controls

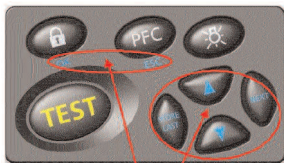

Memory control keys (BLUE)

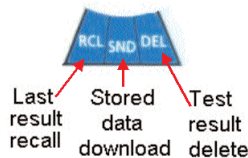

Memory control keys:

STORE:

Store initiates the storing of a test result.

LAST/NEXT:

Selects the type of location; ie job, distribution board, circuit, phase etc.

ESC:

Aborts a save at any time.

OK:

Final operation to save the result.



Selects the job, db, circuit number; ie



01,02,03 etc

Lid open/closure

1. Open lid by lifting up front panel tab (1).
2. Fold-away underneath instrument (2 & 3) and push into retaining slot (4).

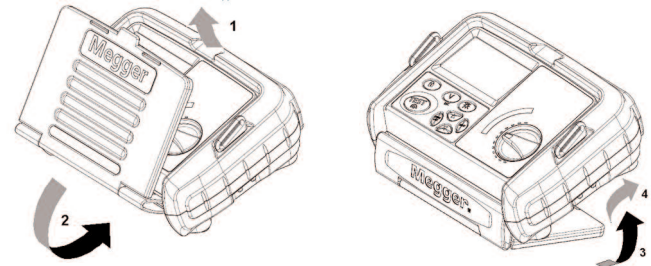

PREPARATIONS FOR USE (ALL INSTRUMENTS)

Batteries

The Megger LT300 series instruments are supplied with batteries fitted. When batteries become exhausted, refer to page 18, battery replacement.

Warning: Do not switch the instrument on with the battery cover removed.

Preliminary test lead check

Functional verification

Before each use of the instrument visually inspect the test leads, prods and crocodile clips to confirm that their condition is good, with no damaged or broken insulation.

GENERAL OPERATING INSTRUCTIONS

Tests lock

The LOCK  indicates when the [Hi] current loop test range is locked ON.

It is activated by holding down the  lock button, and pressing the [TEST] button. When activated, the [Hi] current loop resistance measurement will start when the instrument is connected to a voltage.

The test lock remains on for 30 seconds, after which it resets to off.

Test inhibit

The following conditions may cause the instrument to inhibit testing:

Out of range supply voltage

If an out of range voltage or frequency exists on the circuit under test, or on a very noisy mains supply, testing will be automatically inhibited.

Overheating

Repetitive loop testing generates heat within the instrument. If this heat becomes excessive the instrument will warn the operator and prevent further testing until the instrument has had a chance to cool down.

Fuse Blown

A fuse blown will prevent the instrument from making further tests. The fuse indicator will be displayed.

Default voltmeter

The default voltmeter automatically operates in all test modes, indicating connection to a live system.

Auto power-down

To extend battery life the instrument will automatically switch off six minutes after the last operation.

The instrument can be switched off manually by selecting [OFF] with the

rotary switch, or switched back on again by pressing the [TEST] button.

Backlight operation (LT320 and LT330)

The LT320 and LT330 LCD display may be backlit, to allow readings to be seen in adverse lighting conditions. The backlight function can be selected at any time while the instrument is switched on by pressing the BACKLIGHT  button.

The backlight function will switch off automatically 15 seconds after the instrument has finished testing.

Display warning symbols



Refer to user manual.

Any time the warning triangle is displayed the operator should refer to the user manual for further information.



Range lock

Displayed at any time the [TEST] button is locked in the on position.



Battery condition indication. Refer to page 18.



Fuse blown indicator, appears when an instrument fuse has failed.

Refer to page 17.

>280V Displayed on the LT310 indicates a supply voltage in excess of that allowed is present.

>480V Displayed on the LT320 indicates a supply voltage in excess of that allowed is present.

hot Indicates the instrument needs to cool down before it can continue loop testing



Noise on the circuit under test may affect the reading

Setup procedure

Reverse polarity or line/neutral swapping

This feature is only available on the following models

LT310-EN-SC	LT320-EN-SC
LT310-FR-SC	LT320-FR-SC
LT310-DE-SC	LT320-DE-SC
LT310-ES-SC	LT320-ES-SC
LT310-IT-SC	LT320-IT-SC
LT310-NL-SC	LT320-NL-SC
LT310-NO-SC	LT320-NO-SC

The set-up menu allows the user to change the way the instrument behaves when testing on a supply with Line and Neutral connections swapped. Tests may be permitted or prohibited.

To select Polarity reversal acceptance or rejection:

1. With the instrument switched OFF, hold down the [TEST] button and turn the range knob to any ON position.
2. Keep the button held down until the instrument displays the 'SET' warning.
3. Now release the [TEST] button.
4. Press the [TEST] button again to view the current setting for line/neutral swapping.
5. The display shows 'L+L' (instrument will perform tests with L & N swapped) or 'L+N' (instrument will not perform tests with L & N swapped).
6. Press the [LOCK] button or the PFC button to change the setting.
7. Press the [TEST] button to exit from the set-up menu.

Test leads

All test leads form part of the measuring circuit of the instrument and must not be modified or changed in any way, or be used with any other electrical instrument or appliance.

The mains plug test lead supplied with the Megger tester is a test lead that forms part of the measuring circuit of the instrument. The overall length of this lead must not be altered. If the power cord plug is not suitable for your type of socket outlets, do not use an adapter. You may change the plug once only by cutting the cord as close to the plug as possible and fitting a suitable plug.

The colour code of the cord is:

Earth (Ground)	Yellow/Green
Neutral	Blue
Phase (Line)	Brown

Note: A plug severed from the power cord must be destroyed, as a plug with bare conductors is hazardous in a live socket outlet.

Test lead connection

The supplied test leads should be connected to the appropriate sockets on the rear of the instrument marked L0 and L1, or to the 3 way test socket.

Standard test probes and crocodile clips are supplied for connection to the circuit under test.

The test lead supplied with the LT310, LT320 and LT330 provides connection for 2 wire testing or 3 wire testing, using the 3 wire (red, black and green) lead set (6220-782)

Application

This instrument may be connected live to earth or between live conductors of systems that have a rated voltage of 300V a.c. rms to earth and an installation (overvoltage) Category III or lower.

This means that the instrument may be connected to any fixed wiring of a building installation, but not to primary supply circuits such as overhead cables. To maintain user safety and ensure accurate measurements, only use the test leads supplied or by Megger Limited.

System Diagram - Where To Use Each Test

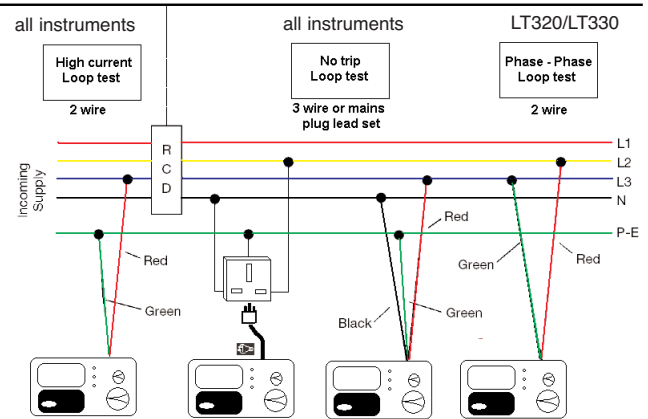









LED indicators

Three RED led indicators show circuit connection status when correctly connected to a live circuit. These are for indication purposes only and should not be relied upon as a indication of the presence of a hazardous voltage.

LOOP TESTING

When connected to the circuit to be tested the three status LED's will show the following supply connection information:

LED indicator	Normal supply	Reversed (L-N) supply	Notes
L - PE			 =ON  OFF Voltage between L- PE greater than 25 V
L - N			Voltage between L-N greater than 25 V
N - PE			Voltage between N-PE greater than 25 V

Warning: Voltage indicator LED's cannot reveal a N-PE supply reversal

Polarity indication

If connected to a single phase power supply by a plug or by the 3-wire lead set, three LED's marked L-PE, N-PE and L-N will indicate supply polarity

Note: The presence of a voltage between phase and earth does not prove earth continuity, as the earth could have a high resistance and a voltage would still be measured. To test earth continuity refers to the sections on loop testing.

Two loop testing options are available: [No Trip] and [Hi].

Non-tripping loop test [No Trip]

Earth loop impedance measurement (at a power socket):

The [No Trip] range is a high resolution (0,01 Ω), low test current earth loop resistance measurement range. It requires a connection to neutral, but allows quick and accurate measurement of the earth loop resistance without tripping all RCDs with a rated current 30 mA or higher.

To perform a [No-Trip] loop test:

Range selection:

1. Select the [No Trip] test range. A non-trip loop test is confirmed on the display with the  symbol
2. On the LT320/LT330 set the top rotary knob to [Z]

Testing:

1. Connect the mains plug test lead to the instrument.
2. Insert the plug into an installation socket.
3. Supply voltage is displayed.
4. Press the [TEST] key.
5. After a test period of up to 20 seconds the measured loop value is displayed.

If desired the test can be repeated by pressing [TEST] again.

Using the three wire lead set

The [No Trip] loop test can be carried out where a power socket is not available using the three wire lead set.

1. Connect the RED lead to Phase, BLACK lead to neutral and GREEN lead to earth.

2. Supply voltage is displayed.
3. Press the [TEST] key.
4. After a test period of up to 20 seconds the measured loop value is displayed.

Hi current loop test [Hi]

The [Hi] Loop test performs a 2-wire loop test, provides a rapid loop test, designed for non-RCD protected circuits.

NOTE: During all [Hi] tests the BLACK neutral test lead does not need to be connected, but for safety reasons Megger recommend it is connected to the same connection point as the GREEN earth test lead.

Range selection:

1. Set the instrument to the [Hi] loop test range. A Hi current loop test is confirmed on the display with the symbol , which indicates the possibility of tripping an RCD if fitted.
2. On the LT320 and LT330 set the top range knob to [Z].

Phase-Earth loop impedance (not at a power socket)

Testing:

1. Connect the Red/Green lead set or the 3-wire test lead to the instrument.
2. Connect the RED [L1] lead to PHASE and the GREEN [L0] lead to EARTH (black lead - connect the black lead to the green lead)
3. The supply voltage is displayed.
4. Press the [TEST] button to start a loop test.
5. After a short delay the measured loop value is displayed.

If desired the test can be repeated by pressing the [TEST] button.

Bonded metalwork testing

Repeat the above test but with the green lead connected to the exposed metalwork.

For a Hi current phase to earth loop impedance measurement at a power socket, repeat the above test using the mains plug test lead supplied.

Phase-Neutral or Phase-Phase loop impedance

1. Connect the Red/Green lead set or the 3-wire test lead to the instrument.
2. Connect the RED [L1] lead to PHASE. Connect the GREEN [L0] lead and the BLACK lead (black lead - ensure the black lead is connected to the green lead) to NEUTRAL (or the 2nd PHASE for Phase to Phase loop measurement).
3. The supply voltage is displayed.
4. Press the [TEST] button to start a loop test.
5. After a short delay the measured loop value is displayed. If desired the test can be repeated by pressing the [TEST] button again.

NOTE: Phase – Phase (415 V) loop test is only possible on the LT320

Prospective fault current display [PFC]

1. On completion of a test, press the [PFC] key.
2. The prospective fault current is displayed in Amps or kA.

NOTES:

The prospective short circuit current (PSCC) of a circuit is the largest prospective fault current (PFC). In a single phase system, this would be the larger of the earth loop PFC and the neutral loop PFC. In a multi-phase system phase-phase loops also need to be considered and these can be measured using the (Hi) switch position.

The PFC is calculated by using the sum:-

$$\text{PFC} = \frac{\text{Nominal supply voltage}}{\text{Loop resistance}}$$

The supply voltage used in the calculation depends on the measured voltage. The instrument uses the following voltage values:-

Actual measured voltage	Nominal voltage
> 50 V and < 80 V	50 V
>80 V and <150 V	110 V
>150 V and <300 V	230 V
>300 V	400 V (LT320 & LT330 only)

PFC measurement accuracy

An accurate PFC measurement requires an accurate measurement of the loop resistance. The difference of a few digits in the loop resistance measured will have a large effect on the PFC displayed.

Warning messages

Noise Indication

The symbol  is displayed when excessive noise caused by other equipment exists on the circuit under test. This noise can affect the accuracy of the loop measurement.

The operator is advised to repeat the measurement or, if the noise symbol continually appears, investigate the cause.

Voltagess greater than 280V [>480V on LT320 and LT330]

LT310: If a voltage greater than 280 V is detected, the display will show >280 V.

LT320

/LT330: If a voltage greater than 480 V is detected between phases the display will show >480 V.

Over temperature hot

To protect the instrument from over heating during Loop testing, thermal protection is fitted. If the message [**hot**] appears in the display together with the  symbol when loop testing, the instrument must be allowed to cool down before further attempts are made at loop testing.

Possible sources of error

The reading depends on a measurement of the supply voltage and therefore noise or transients caused by other equipment during the test could cause an error in the reading. One way to check for these is to do two tests and look for any difference in value. The instrument will detect some sources of noise and warn the user, where other instruments may give an incorrect reading. Any leakage current as a consequence of other appliances connected to the supply under test may affect the reading. If the Phase-Earth loop is being measured, this leakage may be due to filter capacitors, etc.

Test results may be adversely affected by supply voltage fluctuations or electrical 'noise' during a measurement. It is recommended that tests are repeated and the results verified, if measurement results are considered abnormal.

Errors can be reduced by:-

- Use the 2 wire lead set with prods and making a firm connection to clean conductors.

-
- Make several tests and taking the average.
 - Ensure that potential sources of noise in the installation are isolated (switched off), eg: automatically switched loads or motor controllers
 - Ensuring that the instrument is calibrated.

maxZ (LT320 and LT330)

The maximum loop impedance value of any final ring circuit (or any series of loop measurements) can be derived by using the [maxZ] function:

To make a [maxZ] measurement:

1. Select the [maxZ] test range
2. Using either the [No Trip] or [Hi] loop tests, make a series of loop test measurements as described on pages 11 and 12.
3. The display will hold the highest loop measurement, from any number of loop tests. Lower values are displayed momentarily.
4. Turning the range knob away from [maxZ] removes the maxZ stored value.

NOTE: maxZ is not stored when the instrument is switched off (or auto-powers-off), hence auto-power-off time is extended in the Zref and R1+R2 modes to 30 minutes from the standard 6 minutes.

Deriving R1 + R2 (LT320 and LT330)

Automatic Derivation of R1+R2 Values

The LT320 is able to derive the R1+R2 measurement reading from tests made on a live installation.

NOTE: Care should be taken as any parallel earth paths may effect this result.

To make use of this feature, the reference/distribution board result must be stored in the instrument's memory (Zref), prior to measuring R1 + R2

Saving a Zref (distribution) result

1. Switch the range knob to [Zref].
2. Select a [No Trip] or [Hi] loop test as appropriate.
3. Connect the instrument to the circuit under test as described on pages 11 or 12 as required.
4. Press the [TEST] button to perform a loop test.

IMPORTANT NOTES:

When using Zref and R1+R2 functions, we DO NOT recommend changing between [No-Trip] or [Hi] test ranges during the test. Always use the same test method whilst using Zref and R1+R2.

Showing R1+R2

1. After saving a Zref result switch the instrument to R1+R2.
2. All subsequent loop test measurements will have the Zref distribution resistance subtracted.
3. The Zref value can be updated at any time by returning the Range knob to Zref and repeating the loop test.

NOTE: Zref is not stored when the instrument is switched off (or auto powers down), hence auto power-off time is extended in the Z ref and R1+R2 modes to 30 minutes from the standard 6 minutes.

Application note for Zref and R1+R2 measurement:

On initial verification of a new electrical installation, the value for R1+R2 should be obtained by continuity testing methods (dead testing) as per BS 7671:2001

For periodic inspection reports (PIR) where it is not possible to isolate the supply, the user should first verify the circuit protective conductor (standard practice) prior to using the Zref and R1+R2 function on the Megger LT320 or LT330.

VOLTAGE MEASUREMENT

Prior to measuring Z_{ref} , all main equipotential bonding must be in place.

Note: Measurements made on live installations by this method may be lower than the $Z_e + (R1+R2)$ from those obtained by continuity testing methods, due the existence of parallel earth return paths from extraneous conductive parts.

When connected to a system using the three wire lead set or mains plug the instrument indicates the greatest voltage on the system.

Phase to earth voltage measurement

Note: measured voltage must not exceed 300 V phase to earth.

To measure the voltage of the electrical supply:

1. Set the instrument to the [V] range.
2. Connect the GREEN or (L0) lead to the protective earth (PE) and the RED or (L1) lead to the phase to be measured.
3. The instrument will display the phase to earth voltage.

Phase to Phase voltage measurement (LT320 and LT330)

NOTE: measured voltage must not exceed 300 V phase to earth.

To measure the voltage of the electrical supply:

1. Set the instrument to the [V] range.
2. Connect the GREEN or (L0/L2) lead to the first phase, and the RED or (L1) lead to the second phase.
3. The instrument will display the Phase to Phase voltage.

FREQUENCY HZ (LT320 and LT330)

To measure the frequency of the electrical supply:

1. Set the instrument to the [Hz] range.
2. Connect the GREEN or (L0) lead to the protective Earth (PE) and the RED or (L1) lead to the phase to be measured.
3. The instrument will display the frequency in Hz.

PHASE SEQUENCE (LT320 and LT330)

When connected to all conductors of a three phase system, the instrument automatically displays the sequence of phase rotation.

To determine phase sequence

1. Connect the Installation Testers as follows:-

Line 1 Red lead to Red phase

Line 2 Green lead to Yellow phase

Line 3 Black lead to Blue phase

2. The symbol is displayed will show the phase sequence:



indicates R – B – Y sequence (or 1:2:3)



indicates R – Y – B sequence (or 1:3:2)

NOTE: If one of the lines is faulty, neither of the symbols is displayed and just the normal 'neon' polarity indication is shown.

TEST RESULT STORAGE (LT330 ONLY)

Storing LOOP test results:

Results storage has the following structure:

→ 000, → 001...255 = Job number
b00, b01, b02 ...99 = Distribution board No.
c00, c01, c02...99 = Circuit number
R12, RrN,Rr2,Rr1,R1& R2 = Circuit type
P1 to P3 = Phase

→ 000, → 001..... job number acts as work folders. Sets of results can be saved to a particular job number and easily separated when downloaded.

b01, b02... distribution board number:

c01, c02... circuit reference

Results can be assigned a specific distribution board number and circuit reference number.

L-E, L-N... - circuit type: allows a test to be defined as the circuit type.

P1,P2,P3 Phase number: Each test can be stored under a particular phase, P1, P2 or P3.

Unique test number: Each test result is assigned a unique test number, from 0 to 1999 logged automatically. This cannot be changed by the user.

To store a result:

1. Make a Z, MaxZ, Zref or R1+R2 loop measurement as described earlier and Press STORE.
2. Select Job reference number using ↑↓ keys then press NEXT.

(Hold the key down to scroll quickly through the numbers)

3. Select distribution board number (b01,02 etc) using ↑↓ keys then press NEXT
4. Select circuit number (c01,02 etc) using ↑↓ keys then press NEXT
5. Select L-L, L-E, L-N etc by pressing the ↑↓ keys, then press NEXT
6. Select the Phase using ↑↓ keys then press NEXT. The screen will display a unique test number, which is attached to that particular test.
7. Press OK to save the result.

To store a subsequent result:

To save the next test under the same location job number, distribution board etc:

1. Make another measurement as described earlier and press STORE.
2. The last Job number will be displayed. Press OK.
3. The unique test number will be displayed. Press OK and the result is stored.

Note: To change any setting before saving a result, scroll down through the result using the NEXT/LAST keys. Change the reference number using the ↑↓ keys and press OK.

To recall the last test result:

1. Set the range knob to RCL
2. The last unique test number is displayed
3. Press OK and the test result will be displayed.

Note: Only the last test result can be recalled to the display.

To recall the PFC value press LAST or NEXT value if applicable.

REPLACING BATTERIES

Downloading results to a PC:

1. Run Megger Powersuite Professional or Megger Download Manager on the PC
2. Select the appropriate downloading instrument from the list
3. Select "Download from Tester"
4. Connect the tester to the PC using the USB test lead.
5. Set the tester range knob to [Snd].
6. The test data will automatically download its contents to the PC.

A bar graph shows the status of the download.

Deleting test results

To delete the latest test result:

1. Set the range knob to [dEL]. The display will flash "dEL" followed by the test number to be deleted.
2. Press the OK button. The last test result will be will be deleted.

WARNING: This operation is not reversible.

To delete all test data:

1. Set the range knob to [dEL]. The display will flash "dEL".
2. Press the NEXT or LAST key. The display will flash "ALL".
3. Press the OK button. All the test results will be will be deleted.



A bar graph shows the progress of the deletion.

WARNING: This operation is not reversible. All data will be deleted.

Batteries

Battery type: 8 x LR6 (AA), 1.5 V Alkaline, or 8 x 1.2V NiCAD, or 8 x 1.2V NiMH

Low battery warning symbol

The battery condition is continuously displayed by the symbol . When the batteries are exhausted, symbol will show  and the instrument switches off. Batteries should be replaced when 2 bars are displayed.

If the symbol appears as less than fully charged with new batteries fitted, check for correct polarity.

Note: Fully charged NiMH or NiCAD rechargeable batteries show a lower charge than Alkaline batteries, and may not give much warning before becoming exhausted.

To replace batteries

Warning: Do not switch the instrument on with the battery cover removed.

1. Switch off the instrument and disconnect (the instrument) from any electrical circuits.
2. The rear cover must not be opened if the test leads are connected.
3. To remove the rear cover release the screw at the bottom of the cover and lift the cover upwards.
4. Fit new batteries observing the correct polarity as marked on the battery compartment.
5. Replace the cover.

AUTO POWER DOWN

WARNING: - Incorrect battery cell polarity can cause electrolyte leakage, resulting in damage to the instrument.

Check that the battery level indicator displays a full charge before using the instrument. A low battery charge may indicate a reversed cell.

Note: Battery cells should not be left in an instrument which may remain unused for extended periods of time.

Fuse Blown indication

The fuse blown symbol  indicates that an internal fuse has failed. This instrument is fitted with a factory fitted fuse and should only be replaced by an authorised Megger repair centre.

To extend battery life the instrument will automatically switch off six minutes after the last operation. This is extended to 30 minutes when using the Zref, R1 + R2 or maxZ features.

The instrument can be switched off manually by selecting [OFF] with the rotary switch, or switched back on again by pressing the [TEST] button.

PREVENTIVE MAINTENANCE

Clean only with a damp cloth. Do not use any alcohol based cleaning fluids as they may leave a residue.

TECHNICAL SPECIFICATION

General Specification

Only values with tolerances or limits are guaranteed data. Values without tolerances are for information only.

Voltage measurement

Range: 0 V to 500 V

Accuracy: $\pm 2\%$ ± 2 digits

Frequency measurement (LT320 and LT330)

Range: 25Hz to 450Hz

Accuracy: 25.0Hz to 199.9Hz ± 0.1 Hz

200Hz to 450Hz ± 1 Hz

Phase rotation indicator (LT320 and LT330)

Three wire identification of phase rotation.

Loop ranges (to EN 61557-3)

3-wire No Trip Loop (Line to Earth)

Supply

(LT310) 100 V - 280 V 45Hz to 65Hz

(LT320 and LT330) 50 V - 280 V 45Hz to 65Hz

Nominal test current: 15mA line to earth

Loop accuracy

0.01 Ω - 9.99 Ω ($\pm 5\%$ ± 0.03 Ω)

10.0 Ω - 99.9 Ω ($\pm 5\%$ ± 0.5 Ω)

100 Ω - 999 Ω ($\pm 5\%$ ± 5 Ω)

1.00 k Ω - 2.00 k Ω ($\pm 5\%$ ± 30 Ω)

2 wire [HI] loop test

Line/Line(Three phase) (LT320 and LT330)

Supply: 50 V - 480 V 45Hz to 65Hz

Nominal test current 0.25 to 2.4 A

Loop accuracy: 0.01 Ω -99.99 Ω ($\pm 5\% \pm 0.03 \Omega$)

Line/Earth (Single phase)

Supply:

LT310 100 V - 280 V

LT320/LT330 50 V - 280 V

Frequency: 45Hz to 65Hz

Nominal test current: 15 mA to 1.4 A

Loop accuracy:

0.01 Ω - 9.99 Ω ($\pm 5\% \pm 0.03 \Omega$)

10.0 Ω - 99.9 Ω ($\pm 5\% \pm 0.5 \Omega$)

100 Ω - 999 Ω ($\pm 5\% \pm 5 \Omega$)

1.00 k Ω - 2.00 k Ω ($\pm 5\% \pm 30 \Omega$)

Prospective fault current (PFC)

Prospective fault current = Nominal Voltage / Loop resistance

Accuracy is derived from loop test

1 A - 199 A 1 A resolution

0.20 kA - 19.9 kA 10 A resolution

2.0 kA - 19.9 kA 100 A resolution

Temperature and humidity

Operating range: -5°C to +40°C

Operating humidity: 93% R.H. at +40°C max.

Storage range: -25°C to +70°C

Maximum altitude: 2000 m

Environmental protection: Weather proof to IP54

Safety

Meets the requirements of EN61010-1 Cat III 300 V phase to earth.

IEC61557

Complies with the following parts of EN61557, Electrical safety in low voltage systems up to 1000 V ac and 1500 V d.c.- Equipment for testing, measuring or monitoring of protective measures:

Part1 - General Requirements

Part3 - Loop resistance

Power supply

Battery: 8 x 1.5 V cells IEC LR6 type(AA alkaline).

Rechargeable: NiCAD or NiMH cells may be used.

Battery condition is constantly shown on the display as a four-section bar graph. (with 2 bars per section)

Battery life: 2000 consecutive tests on any test using quality batteries.

Weight

All units: 980gms

BASIC AND SERVICE ERRORS

Dimensions

All units: 203 x 148 x 78 mm

E.M.C

In accordance with IEC61326 including amendment No.1

Basic and service errors Loop test ranges

The basic error is the maximum inaccuracy of the instrument under ideal conditions, whereas the service error is the maximum inaccuracy taking into effect of battery voltage, temperature, interference, and system voltage and frequency, where applicable.

ACCESSORIES

Item	Order Code
3 wire test lead set and crocodile clips	6220-782
Mains plug test lead (BS 1363) (BS Versions)	6220-740
Mains plug test lead CEE 7/7 (EN versions)	6220-741
Mains plug test lead (AS/NZS 3112) (AU versions)	6220-790
USB download lead	25970-041
Download Manager CD	6111-442
Quick start guide	5174-188

Megger certification software

PowerSuite Pro-Lite 16th

REPAIR AND WARRANTY

The instrument contains static sensitive devices, and care must be taken in handling the printed circuit board. If an instrument's protection has been impaired it should not be used, but sent for repair by suitably trained and qualified personnel. The protection is likely to be impaired if for example; it shows visible damage; fails to perform the intended measurements; has been subjected to prolonged storage under unfavourable conditions, or has been subjected to severe transport stresses.

NEW INSTRUMENTS ARE GUARANTEED FOR 3 YEARS FROM THE DATE OF PURCHASE BY THE USER.

Note: Any unauthorized prior repair or adjustment will automatically invalidate the Warranty.

INSTRUMENT REPAIR AND SPARE PARTS

For service requirements for Megger Instruments **contact:**

Megger Limited	or	Megger
Archcliffe Road		Valley Forge Corporate Centre
Dover		2621 Van Buren Avenue
Kent CT17 9EN		Norristown PA 19403
England.		U.S.A.

Tel: +44 (0) 1304 502 243 Tel: +1 610 676 8579

Fax: +44 (0) 1304 207 342 Fax: +1 610 676 8625

or an approved repair company.

UKrepairs@megger.com

Returning and Instrument for Repair

If it is necessary to return an instrument for repair, a Returns Authorisation number must first be obtained by contacting one of the addresses shown. You will be asked to provide key information, such as the instrument serial number and fault reported when the number is issued. This will enable the Service Department to prepare in advance for the receipt of your instrument, and to provide the best possible service to you.

The Returns Authorisation number should be clearly marked on the outside of the product packaging, and on any related correspondence. The instrument should be sent, freight paid to the appropriate address. If appropriate a copies of the original purchase invoice and of the packing note, should be sent simultaneously by airmail to expedite clearance through customs.

For instruments requiring repair outside the warranty period a repair estimate will be submitted to the sender, if required, before work on the instrument commences.

Approved Repair Companies

A number of independent instrument repair companies have been authorised for repair work on most Megger instruments, using genuine Megger spare parts. A list of approved companies is available from the UK address shown on this page. Spare parts are also available.



Megger Limited
Archcliffe Road, Dover
Kent CT17 9EN England
T +44 (0)1 304 502101
F +44 (0)1 304 207342
E uksales@megger.com

Megger
4271 Bronze Way, Dallas,
Texas 75237-1019 USA
T +1 800 723 2861 (USA ONLY)
T +1 214 333 3201
F +1 214 331 7399
E ussales@megger.com

Megger
Z.A. Du Buisson de la Coudre
23 rue Eugène Henaff
78190 TRAPPES France
T +33 (0)1 30.16.08.90
F +33 (0)1 34.61.23.77
E infos@megger.com

Megger Pty Limited
Unit 26 9 Hudson Avenue
Castle Hill
Sydney NSW 2125 Australia
T +61 (0)2 9659 2005
F +61 (0)2 9659 2201
E ausales@megger.com

Megger Limited
110 Milner Avenue Unit 1
Scarborough Ontario M1S 3R2
Canada
T +1 416 298 9688 (Canada only)
T +1 416 298 6770
F +1 416 298 0848
E casales@megger.com

Megger products are distributed in 146 countries worldwide.

**This instrument is manufactured in the United Kingdom.
The company reserves the right to change the specification or design without prior notice.**

Megger is a registered trademark

Part No. LT300_UG_en_V03 1005
www.megger.com