

Datasheet

Industrial Adaptor

Stock No:
2144139



Image for reference only

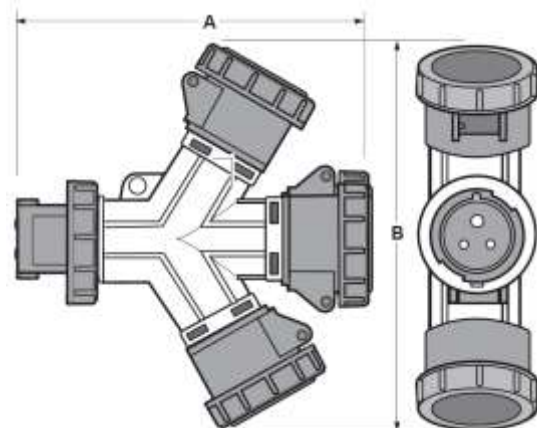

A:285 B:280 Dimensions in mm

Configuration

Inlet/Plug	IEC 60309 Plug 32A 3P+T 400V
Outlet / Socket-Outlet	3x IEC 60309 Socket-Outlet 32A 3P+T 400V

Technical Characteristics

Rated Current:	32
Rated Voltage	400
Poles	3P+T
IP Protection Degree	IP20 (IEC / EN 60529)
Glow Wire Test	850°C live parts supports /650°C other parts
Material	Housing: PA6/ABS
Product Standard	IEC/EN 60309-1, IEC/EN 60309-2
Note	-