

Vacuum generators VN

FESTO

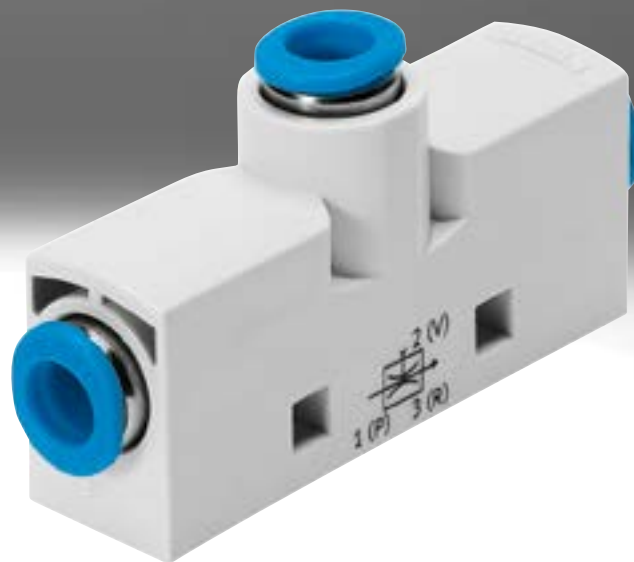

Festo Core Range
Solves the majority of your automation tasks

Worldwide:
Simply good:
Fast:

Quickest delivery – wherever, whenever
Expected high Festo quality
Easy and fast to select

With the Festo Core Range, we have selected the most important products and functions from our broad product catalogue, and added the quickest delivery.

The Core Range offers you the best value for your automation tasks.

Just look
for the
star!

Key features

Product overview

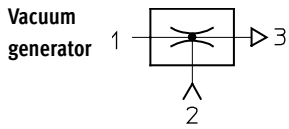

All vacuum generators from Festo have a single-stage design and operate according to the Venturi principle. The product series described below have been designed for a wide range of

applications. The different performance classes of the individual product series make it possible to select vacuum generators that are optimally

tailored to the specific requirements of each application.

Standard and inline ejectors

VN-...

→ Page 13



- Nominal width 0.45 ... 3 mm
- Max. vacuum 93%
- Temperature range 0 ... +60°C
- A range of extremely effective generators suitable for use directly in the work space
- Available in straight or T-shaped design
- Small footprint
- Cost effective
- No wearing parts
- Extremely fast evacuation time
- Optional vacuum switch
- Optional additional functions:
 - Integrated ejector pulse
 - Electrical control for vacuum ON/OFF
 - Combination of ejector pulse and actuation

VAD-.../VAK-...

Datasheets → Internet: vad



- Nominal width 0.5 ... 1.5 mm
- Max. vacuum 80%
- Temperature range -20 ... +80°C
- Range of vacuum generators with sturdy aluminium housing
- VAK-...: integrated volume, VAD-...: connection for external volume
- Maintenance-free
- VAK-...: reliable setting down of workpieces

Key features

Compact ejectors

VADM-.../VADMI-...

Datasheets → Internet: vadm



- Nominal width
0.45 ... 3 mm
- Max. vacuum
84%
- Temperature range
0 ... +60°C
- Compact design
- Minimal installation effort
- Short switching times
- Built-in solenoid valve
(on/off)
- VADMI-...: additional integrated
solenoid valve for ejector pulse
- Filter with display
- Optional air saving function
- Optional vacuum switch
- Reliable setting down of workpieces

VAD-M-.../VAD-M-I-...

Datasheets → Internet: vad-m



- Nominal width
0.7 ... 2 mm
- Max. vacuum
85%
- Temperature range
0 ... +40°C
- Compact design
- Minimal installation effort
- Short switching times
- Built-in solenoid valve
(on/off)
- VAD-M-I-...: additional integrated
solenoid valve for ejector pulse
- Reliable setting down of workpieces

Key features

At a glance

- Vacuum generators for high vacuum up to 93%
- Laval nozzles in six nominal widths:
 - 0.45 mm
 - 0.70 mm
 - 0.95 mm
 - 1.4 mm
 - 2.0 mm
 - 3.0 mm
- Vacuum generators for high suction rates and thus particularly short evacuation times
- Small footprint
- Compact and sturdy design
- Wear- and maintenance-free
- Modular principle: large selection of different types
- Can be used directly in the work space, making them very effective
- Plastic housing
- Flexible connection options:
 - Push-in connector QS
 - Screw-in thread
 - Push-in sleeve
 - Screw-in silencer
- Easy to mount thanks to the double-sided latching function of the mounting plate
- With or without integrated vacuum switch for monitoring the vacuum with PNP output

Two housing types

T-shape

Connection options:

- Push-in connectors QS
- Female thread
- Male thread
- Silencer

Mounting options:

- Direct mounting via screws
- Indirect mounting with latching onto a mounting plate. This plate is suitable for H-rail 35x7.5 to DIN EN 50022.

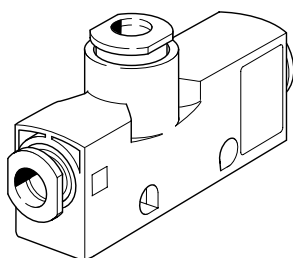

Straight shape

Connection options:

- Push-in connectors QS
- Push-in sleeve

Mounting options:

Particularly compact housing with compressed air and vacuum connection in one line and unducted exhaust air. This means this design can be installed directly in the tubing line.

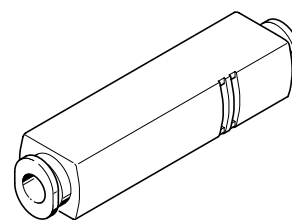

Two operating principles

Standard

- T-shaped housing

Design:

Compressed air and vacuum connection offset by 90°. The extracted volumetric flow rate is deflected by 90° from front to back.

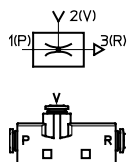

Inline

- T-shaped housing
- Straight housing without exhaust port for space-saving installation in a tubing line or directly in the suction cup holder

Design:

Compressed air and vacuum connection arranged in one line.

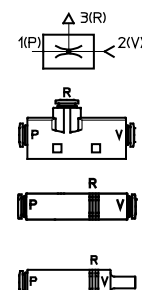

Key features

Two versions

High vacuum
up to 93%

Vacuum p_u as a function of operating pressure p_1

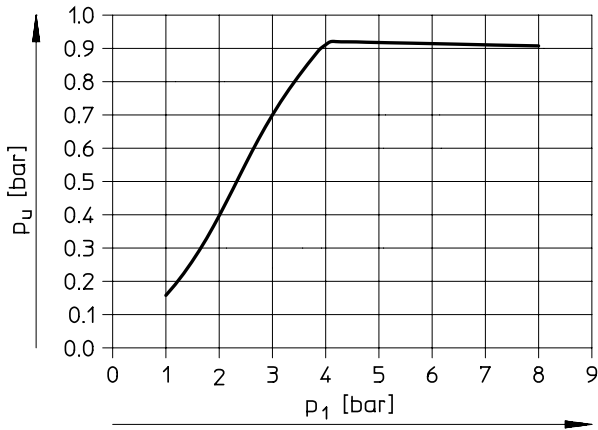

High suction rate

up to 339 l/min, enabling particularly short evacuation times.

Suction rate q_{ns} as a function of operating pressure p_1

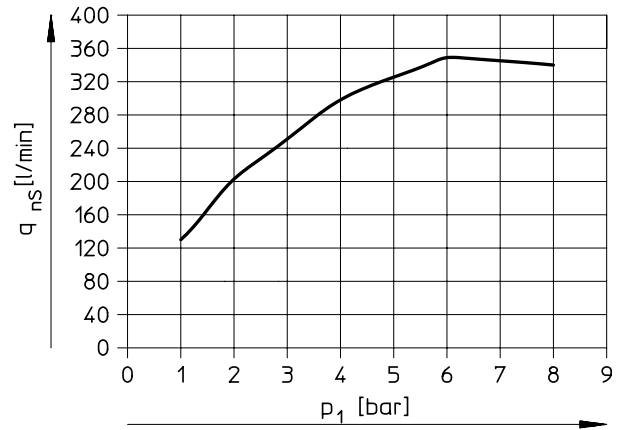

System comparison



High vacuum – high suction rate

Generators of the first type are optimised for generating a high vacuum at comparatively low suction rates.

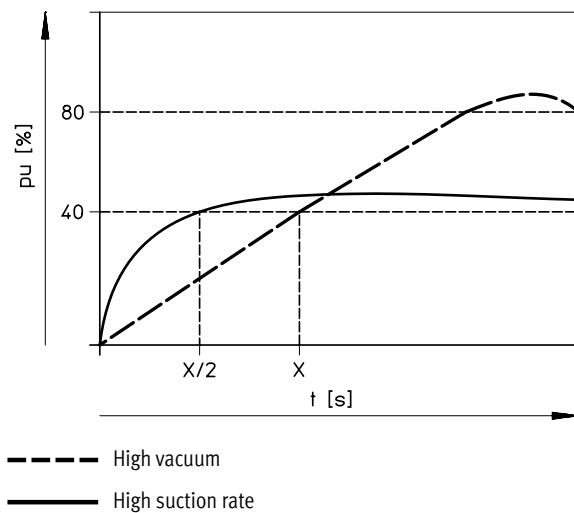
In contrast, the second type of generator can achieve very short evacuation times because of the high suction rate at relatively low vacuum.



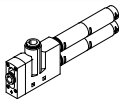
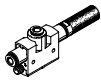
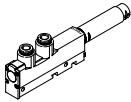
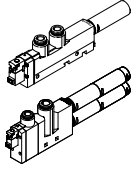
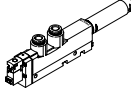
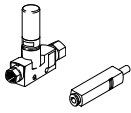

Product range overview

Function	Design	Type	Nominal width of Laval nozzle [mm]	Grid dimension							Pneumatic connection 1		
				T-shape					Straight shape		Push-in fitting PQ	Female thread PI	
				10 [mm]	14 [mm]	16 [mm]	18 [mm]	24 [mm]	10 [mm]	13 [mm]			14.5 [mm]
High vacuum	Standard H												
		VN-05-H	0.45	■	-	-	-	-	-	-	-	■	■
		VN-07-H	0.7	■	-	-	-	-	-	-	-	■	■
		VN-10-H	0.95	-	■	-	■	-	-	-	-	■	■
		VN-14-H	1.4	-	-	-	■	-	-	-	-	■	■
		VN-20-H	2.0	-	-	-	-	■	-	-	-	■	■
		VN-30-H	3.0	-	-	-	-	■	-	-	-	■	■
	Standard H with integrated vacuum switch												
		VN-05-H-...-P	0.45	-	-	■	-	-	-	-	-	■	-
		VN-07-H-...-P	0.7	-	-	■	-	-	-	-	-	■	-
		VN-10-H-...-P	0.95	-	-	■	-	-	-	-	-	■	-
	Standard H with pneumatic ejector pulse												
		VN-05-H-...-A	0.45	-	■	-	-	-	-	-	-	■	■
		VN-07-H-...-A	0.7	-	■	-	-	-	-	-	-	■	■
		VN-10-H-...-A	0.95	-	-	-	■	-	-	-	-	■	■
		VN-14-H-...-A	1.4	-	-	-	■	-	-	-	-	■	■
	Standard H with electric on/off valve												
		VN-05-H-...-M	0.45	-	■	-	-	-	-	-	-	■	-
		VN-07-H-...-M	0.7	-	■	-	-	-	-	-	-	■	-
		VN-10-H-...-M	0.95	-	-	-	■	-	-	-	-	■	-
		VN-14-H-...-M	1.4	-	-	-	■	-	-	-	-	■	-
		VN-20-H-...-M	2.0	-	-	-	-	■	-	-	-	■	-
		VN-30-H-...-M	3.0	-	-	-	-	■	-	-	-	■	-
	Standard H with electric on/off valve and pneumatic ejector pulse												
	VN-05-H-...-B	0.45	-	■	-	-	-	-	-	-	■	-	
	VN-07-H-...-B	0.7	-	■	-	-	-	-	-	-	■	-	
	VN-10-H-...-B	0.95	-	-	-	■	-	-	-	-	■	-	
	VN-14-H-...-B	1.4	-	-	-	■	-	-	-	-	■	-	
Inline M													
	VN-05-M	0.45	■	-	-	-	-	-	-	-	■	■	
			-	■	-	-	-	-	-	■	-	-	
			-	-	-	-	-	■	-	-	■	-	
	VN-07-M	0.7	■	-	-	-	-	-	-	-	■	■	
			-	■	-	-	-	■	-	-	■	-	
VN-10-M	0.95	-	-	-	-	-	-	-	■	■	-		
Inline M with ejector pulse, pneumatic													
	VN-05-M-...-A	0.45	-	-	-	-	-	-	-	■	■	-	
	VN-07-M-...-A	0.7	-	-	-	-	-	-	-	■	■	-	

Product range overview

Type	Vacuum connection				Pneumatic connection 3			Switching function		→ Page/ Internet
	Push-in fitting VQ	Female thread VI	Male thread VA	Push-in sleeve VT	Push-in fitting RQ	Female thread RI	Silencer RO	Fixed hysteresis O1	Variable hysteresis O2	
Standard H										
VN-05-H	■	■	–	–	■	■	■	–	–	11
VN-07-H	■	■	–	–	■	■	■	–	–	
VN-10-H	■	■	■	–	■	■	■	–	–	
VN-14-H	■	■	■	–	■	■	■	–	–	
VN-20-H	■	■	■	–	–	–	■	–	–	
VN-30-H	■	■	■	–	–	–	■	–	–	
Standard H with integrated vacuum switch										
VN-05-H-...-P	■	–	–	–	–	–	–	■	■	26
VN-07-H-...-P		–	–	–	–	–	–	–	–	
VN-10-H-...-P		–	–	–	–	–	–	–	–	
Standard H with pneumatic ejector pulse										
VN-05-H-...-A	■	■	–	–	–	–	■	–	–	32
VN-07-H-...-A										
VN-10-H-...-A										
VN-14-H-...-A										
Standard H with electric on/off valve										
VN-05-H-...-M	■	–	–	–	–	–	■	–	–	32
VN-07-H-...-M										
VN-10-H-...-M										
VN-14-H-...-M										
VN-20-H-...-M										
VN-30-H-...-M										
Standard H with electric on/off valve and pneumatic ejector pulse										
VN-05-H-...-B	■	–	–	–	–	–	■	–	–	32
VN-07-H-...-B										
VN-10-H-...-B										
VN-14-H-...-B										
Inline M										
VN-05-M	■	■	–	–	■	■	■	–	–	11
	■	–	–	■	–	–	–	–	–	
VN-07-M	■	■	–	–	■	■	■	–	–	
	■	–	–	■	–	–	–	–	–	
VN-10-M	■	–	–	–	–	–	–	–	–	
Inline M with ejector pulse, pneumatic										
VN-05-M-...-A	■	–	–	–	–	–	–	–	–	32
VN-07-M-...-A										

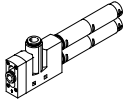
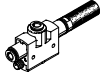
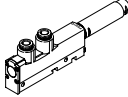
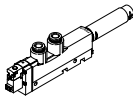
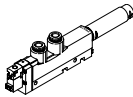
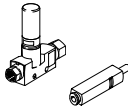
Product range overview

Function	Design	Type	Nominal width of Laval nozzle [mm]	Grid dimension									Pneumatic connection 1	
				T-shape					Straight shape				Push-in fitting PQ	Female thread PI
				10 [mm]	14 [mm]	16 [mm]	18 [mm]	24 [mm]	10 [mm]	13 [mm]	14.5 [mm]			
High suction rate	Standard L													
		VN-05-L	0.45	■	-	-	-	-	-	-	-	-	■	■
		VN-07-L	0.7	-	■	-	-	-	-	-	-	-	■	■
		VN-10-L	0.95	-	■	-	■	-	-	-	-	-	■	■
		VN-14-L	1.4	-	-	-	■	-	-	-	-	-	■	■
		VN-20-L	2.0	-	-	-	-	■	-	-	-	-	■	■
		VN-30-L	3.0	-	-	-	-	■	-	-	-	-	■	■
	Standard L with integrated vacuum switch													
		VN-05-L...-P	0.45	-	-	■	-	-	-	-	-	-	■	-
		VN-07-L...-P	0.7	-	-	■	-	-	-	-	-	-	■	-
		VN-10-L...-P	0.95	-	-	■	-	-	-	-	-	-	■	-
	Standard L with pneumatic ejector pulse													
		VN-05-L...-A	0.45	-	■	-	-	-	-	-	-	-	■	■
		VN-07-L...-A	0.7	-	■	-	-	-	-	-	-	-	■	■
		VN-10-L...-A	0.95	-	■	-	■	-	-	-	-	-	■	■
		VN-14-L...-A	1.4	-	-	-	■	-	-	-	-	-	■	■
	Standard L with electric on/off valve													
		VN-05-L...-M	0.45	-	■	-	-	-	-	-	-	-	■	-
		VN-07-L...-M	0.7	-	■	-	-	-	-	-	-	-	■	-
		VN-10-L...-M	0.95	-	■	-	■	-	-	-	-	-	■	-
		VN-14-L...-M	1.4	-	-	-	■	-	-	-	-	-	■	-
	Standard L with electric on/off valve and pneumatic ejector pulse													
		VN-05-L...-B	0.45	-	■	-	-	-	-	-	-	-	■	-
		VN-07-L...-B	0.7	-	■	-	-	-	-	-	-	-	■	-
VN-10-L...-B		0.95	-	■	-	■	-	-	-	-	-	■	-	
VN-14-L...-B		1.4	-	-	-	■	-	-	-	-	-	■	-	
Inline N														
	VN-05-N	0.45	-	■	-	-	-	-	-	-	-	■	■	
			-	-	-	-	-	-	■	-	-	■	-	
Inline N with ejector pulse, pneumatic														
	VN-05-N...-A	0.45	-	-	-	-	-	-	-	■	-	■	-	
	VN-07-N...-A	0.7	-	-	-	-	-	-	-	■	-	■	-	

Product range overview

Type	Vacuum connection				Pneumatic connection 3			Switching function		→ Page/ Internet
	Push-in fitting VQ	Female thread VI	Male thread VA	Push-in sleeve VT	Push-in fitting RQ	Female thread RI	Silencer RO	Fixed hysteresis O1	Variable hysteresis O2	
Standard L										
VN-05-L	■	■	– ■	–	■	■	■	–	–	11
VN-07-L	■	■	■	–	■	■	■	–	–	
VN-10-L	■	■ –	■	–	■	■ –	■	–	–	
VN-14-L	■	■	■	–	■	■	–	–	–	
VN-20-L	■	■	■	–	–	–	■	–	–	
VN-30-L	–	■	■	–	–	–	■	–	–	
Standard L with integrated vacuum switch										
VN-05-L...P	■	–	–	–	–	–	–	■	■	26
VN-07-L...P										
VN-10-L...P										
Standard L with pneumatic ejector pulse										
VN-05-L...A	■	■	–	–	–	–	■	–	–	32
VN-07-L...A										
VN-10-L...A										
VN-14-L...A										
Standard L with electric on/off valve										
VN-05-L...M	■	–	–	–	–	–	■	–	–	32
VN-07-L...M										
VN-10-L...M										
VN-14-L...M										
Standard L with electric on/off valve and pneumatic ejector pulse										
VN-05-L...B	■	–	–	–	–	–	■	–	–	32
VN-07-L...B										
VN-10-L...B										
VN-14-L...B										
Inline N										
VN-05-N	■	■	–	–	■	■	■	–	–	11
	■	–	–	■	–	–	–	–	–	
Inline N with ejector pulse, pneumatic										
VN-05-N...A	■	–	–	–	–	–	–	–	–	32
VN-07-N...A										

Product range overview

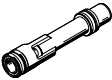
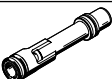
Function	Design	Type	Nominal width of Laval nozzle [mm]	→ Page/ Internet
High vacuum	Vacuum generator cartridge, standard H			42
		VN-05-H	0.45	
		VN-07-H	0.7	
		VN-10-H	0.95	
		VN-14-H	1.4	
		VN-20-H	2.0	
High suction rate	Vacuum generator cartridge, standard L			42
		VN-05-L	0.45	
		VN-07-L	0.7	
		VN-10-L	0.95	
		VN-14-L	1.4	
		VN-20-L	2.0	

Peripherals overview

VN-05/07/10/14
Straight shape

T-shape

VN-20/30

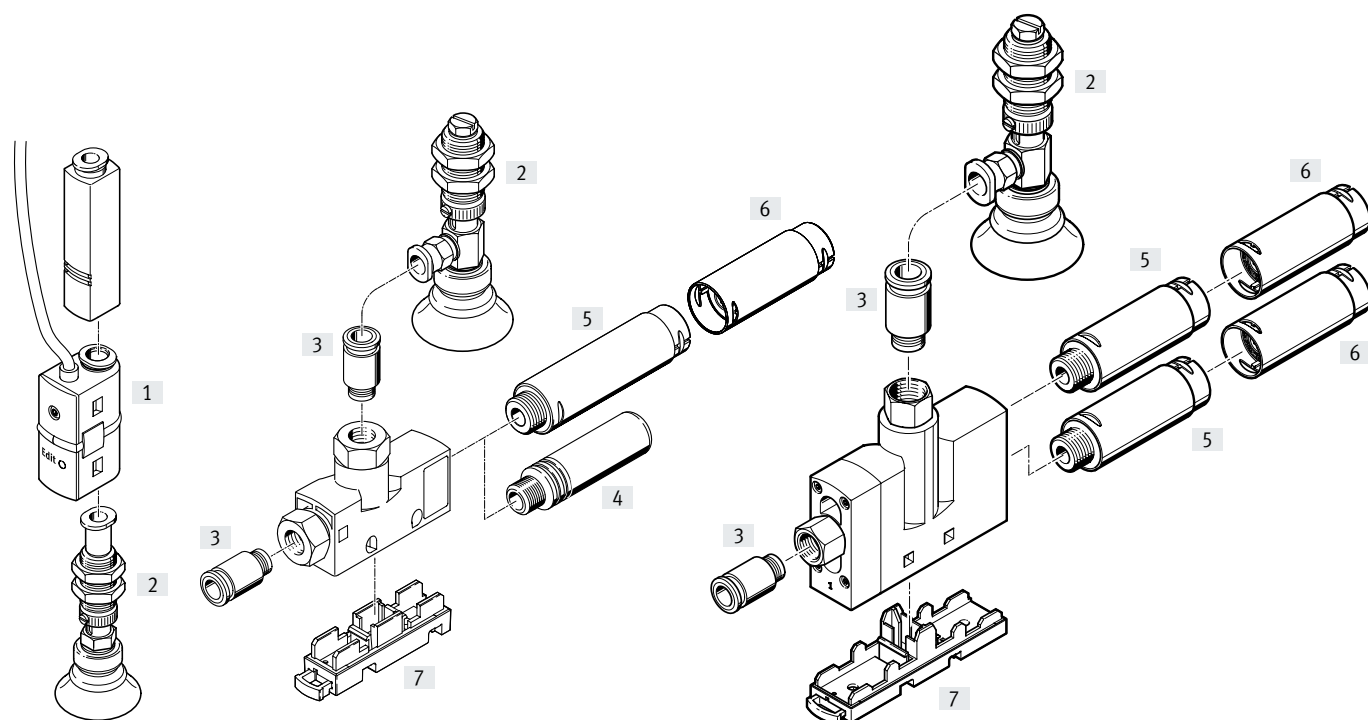

Mounting attachments and accessories

	VN-05/07/10/14		VN-20/30			→ Page/ Internet
	Straight shape		T-shape			
	10 mm	13 mm	10 mm	14 mm	18 mm	
[1] Pressure switch SDE5		■			■	sde5
[2] Suction gripper ESG		■		■		esg
[3] Push-in fitting QS		–		■		qs
[4] Silencer UO		–	■	■	■	46
Silencer AMTE		–	■	■	■	46
[5] Silencer UOM		–	–	–	■	46
[6] Silencer extension UOMS		–	–	–	■	46
[7] Mounting plate VN-.....BP-NRH		–		■		45
– Suction cup holder ESH		■		■		esh
– Suction cup ESS		■		■		ess

Type codes

VN, pneumatic

001	Series
VN	Vacuum generator
002	Nominal width of Laval nozzle
05	0.45 mm
07	0.70 mm
10	0.95 mm
14	1.4 mm
20	2.0 mm
30	3.0 mm
003	Ejector characteristics
H	High vacuum/standard
L	High suction rate/standard
M	High vacuum/inline
N	High suction rate/inline
004	Housing type
I2	Straight shape, pitch 10 mm
I3	Straight shape, pitch 13 mm
T2	T-shape, pitch 10 mm
T3	T-shape, pitch 14 mm
T4	T-shape, pitch 18 mm
T6	T-shape, pitch 24 mm
005	Housing type
I3	Straight shape, pitch 14.5 mm
T4	T-shape, pitch 16 mm
006	Compressed air connection
PQ1	Push-in connector 4 mm
PQ2	Push-in connector 6 mm
PQ3	Push-in connector 8 mm
PQ4	Push-in connector 10 mm
PI2	Female thread M5
PI4	Female thread G1/8
PI5	Female thread G1/4

007	Vacuum connection
VQ1	Push-in fitting QS-4
VQ2	Push-in fitting QS-6
VQ3	Push-in fitting QS-8
VQ5	Push-in fitting QS-12
VI2	Female thread M5
VI4	Female thread G1/8
VI5	Female thread G1/4
VI6	Female thread G3/8
VA4	Male thread G1/8
VA5	Male thread G1/4
VT1	Push-in sleeve 4 mm
VT2	Push-in sleeve 6 mm
008	Switching function
O1	Threshold value with fixed hysteresis, 2 teach-in points, N/O contact
O2	Threshold value with variable hysteresis, N/O contact
009	Electrical output
	None
P	Switching output PNP
010	Exhaust port
RQ1	Push-in fitting QS-4
RQ2	Push-in fitting QS-6
RQ3	Push-in fitting QS-8
RI2	Female thread M5
RI4	Female thread G1/8
RI5	Female thread G1/4
RO1	Silencer UO
RO2	Silencer UOM
011	Integrated function
	None
A	Ejector pulse, pneumatic

VN, electropneumatic

001	Series
VN	Vacuum generator
002	Nominal width of Laval nozzle
05	0.45 mm
07	0.70 mm
10	0.95 mm
14	1.4 mm
20	2.0 mm
30	3.0 mm
003	Ejector characteristics
H	High vacuum/standard
L	High suction rate/standard
004	Housing type
T3	T-shape, pitch 14 mm
T4	T-shape, pitch 18 mm
T6	T-shape, pitch 24 mm

005	Compressed air connection
PQ2	Push-in connector 6 mm
PQ3	Push-in connector 8 mm
PQ4	Push-in connector 10 mm
006	Vacuum connection
VQ2	Push-in fitting QS-6
VQ3	Push-in fitting QS-8
VQ5	Push-in fitting QS-12
007	Exhaust port
RO1	Silencer UO
RO2	Silencer UOM
008	Integrated function
B	Electric on/off valve and pneumatic ejector pulse
M	Electric on/off valve

Datasheet

Function standard

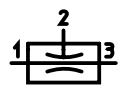

Inline

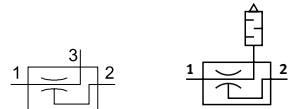
 -  - Temperature range
0 ... +60°C

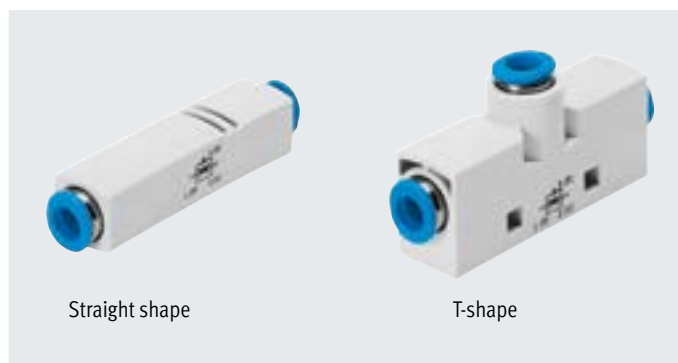
 -  - Operating pressure
1 ... 8 bar

Straight shape

T-shape

General technical data – Standard

Design	T-shape									
Type	VN-05		VN-07		VN-10		VN-14	VN-20	VN-30	
Grid dimension [mm]	10	14	10	14	14	18	18	24	24	
Nominal width of Laval nozzle [mm]	0.45		0.7		0.95		1.4	2.0	3.0	
Ejector characteristic	High vacuum H									
	High suction rate L				High suction rate L					
Pneumatic connection 1	Push-in fitting	QS-4	QS-6	QS-4	QS-6	QS-6	QS-6	QS-6	QS-10	QS-10
	Female thread	M5	G1/8	M5	G1/8	G1/8	–	G1/8	G1/4	G1/4
Vacuum connection	Push-in fitting	QS-4	QS-6	QS-4	QS-6	QS-6	QS-8	QS-8	QS-12	QS-12
	Male thread	–	G1/8	–	G1/8	G1/8	G1/4	G1/4	G1/4	G1/4
	Female thread	M5	G1/8	M5	G1/8	G1/8	–	G1/4	G3/8	G3/8
Pneumatic connection 3	Push-in fitting	QS-4	QS-6	QS-4	QS-6	QS-6	QS-8	QS-8	–	–
	Female thread	M5	G1/8	M5	G1/8	G1/8	–	G1/4	–	–
	Silencer	Open	Open	Open	Open	Open	Open	Open	Open	Open
Type of mounting (max. tightening torque)	With through-hole (0.5 Nm)							With through-hole (0.8 Nm)		
	Via accessories									
Mounting position	Any									

General technical data – Inline

Design	T-shape				Straight shape					
Type	VN-05		VN-07		VN-05		VN-07		VN-10	
Grid dimension [mm]	10	14	10	14	10	13	10	13	13	
Nominal width of Laval nozzle [mm]	0.45		0.7		0.45		0.7		0.95	
Ejector characteristic	High vacuum M									
	–	High suction rate N		–	–	High suction rate N		–	–	
Pneumatic connection 1	Push-in fitting	QS-4	QS-6	QS-4	QS-6	QS-4	QS-6	QS-4	QS-6	QS-6
	Female thread	M5	G1/8	M5	G1/8	–				
Vacuum connection	Push-in fitting	QS-4	QS-6	QS-4	QS-6	QS-4	QS-6	QS-4	QS-6	QS-6
	Female thread	M5	G1/8	M5	G1/8	–				
	Push-in sleeve	–				QS-4	QS-6	QS-4	QS-6	–
Pneumatic connection 3	Push-in fitting	QS-4	QS-6	QS-4	QS-6	Not ducted				
	Female thread	M5	G1/8	M5	G1/8	–				
	Silencer	Open	Open	Open	Open	–				
Type of mounting (max. tightening torque)	With through-hole (0.5 Nm)				In-line installation					
	Via accessories									
Mounting position	Any									

† Note: This product corresponds to ISO 1179-1 and ISO 228-1.

Datasheet

Operating and environmental conditions	
Operating pressure [bar]	1 ... 8
Nominal operating pressure [bar]	6
Operating medium	Compressed air to ISO 8573-1:2010 [7:4:4]
Note on the operating/pilot medium	Lubricated operation not possible
Ambient temperature [°C]	0 ... +60
Temperature of medium [°C]	0 ... +60
Corrosion resistance class CRC ¹⁾	1 (with push-in fitting)
	2 (without push-in fitting, with the exception of VN-...-T3-...-RO1 → CRC 1)

- 1) Corrosion resistance class CRC 1 to Festo standard FN 940070
 Low corrosion stress. Dry internal application or transport and storage protection. Also applies to parts behind covers, in the non-visible interior area, or parts that are covered in the application (e.g. drive trunnions).
 Corrosion resistance class CRC 2 to Festo standard FN 940070
 Moderate corrosion stress. Indoor applications in which condensation can occur. External visible parts with primarily decorative surface requirements that are in direct contact with a normal industrial environment.

Performance data – High vacuum										
Ejector characteristic		Standard H						Inline M		
Nominal width of Laval nozzle [mm]		0.45	0.7	0.95	1.4	2.0	3.0	0.45	0.7	0.95
Max. vacuum [%]		88	88	89	88	92	93	86	86	86
Operating pressure for max. vacuum [bar]		4.5	4.7	4.5	5.0	3.5	3.7	6.0	5.8	5.8
Max. suction rate with respect to atmosphere [l/min]		6.2	16	25	51.6	98	186	6.1	13.5	28
Operating pressure for max. suction rate [bar]		2.1	2.1	3.1	5.1	2.0	3.0	6.3	7.0	5.0
Pressurisation time at nominal operating pressure 6 bar (for 1 l volume) ¹⁾ [s]		4.8	1.9	1.1	0.5	0.2	0.1	4.7	2.1	0.96
Noise level at nominal operating pressure 6 bar [dB (A)]		53	64	74 (RO1) 71 (RO2)	69	63	78	53	59	–

- 1) Time required to reduce the vacuum to a residual vacuum of –0.05 bar after switching off the operating pressure.

Performance data – High suction rate								
Ejector characteristic		Standard L					Inline N	
Nominal width of Laval nozzle [mm]		0.45	0.7	0.95	1.4	2.0	3.0	0.45
Max. suction rate with respect to atmosphere [l/min]		15.7	38.8	62.7	90.0	188.0	339.0	12.0
Operating pressure for max. suction rate [bar]		5.0	6.2	4.0	8.0	3.0	6.0	6.0
Pressurisation time at nominal operating pressure 6 bar (for 1 l volume) ¹⁾ [s]		1.7	0.5	0.46	0.25	0.15	0.1	1.57
Noise level at nominal operating pressure 6 bar [dB (A)]		53	66	73 (RO1) 72 (RO2)	77	60	70	48

- 1) Time required to reduce the vacuum to a residual vacuum of –0.05 bar after switching off the operating pressure.

Datasheet

Materials

Sectional view

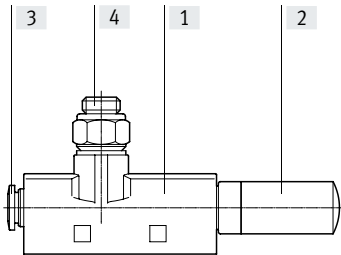

Vacuum generator VN-05/07/10/14			
[1]	Housing	Reinforced POM	
[2]	Silencer	RO1	PE
		RO2	Die-cast aluminium, POM; PU foam
[3]	Push-in fitting	Nickel-plated brass	
[4]	Connecting thread	VA	Wrought aluminium alloy
		PI, VI, RI	Anodised wrought aluminium alloy
		T3-RO1	Nickel-plated brass
-	Jet nozzle	Wrought aluminium alloy	
-	Female nozzle	POM	
-	Seals	NBR	
Note on materials		RoHS-compliant	
		RO2	Contains paint-wetting impairment substances

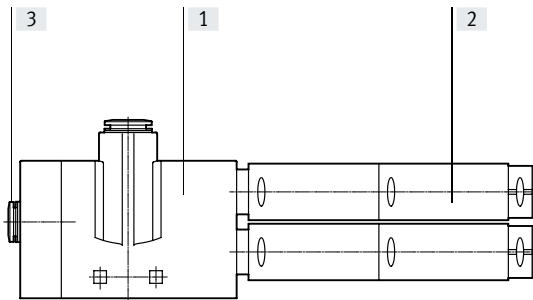

Vacuum generator VN-20/30			
[1]	Housing	Reinforced POM	
[2]	Silencer	Die-cast aluminium, POM, PU foam	
[3]	Push-in fitting	Nickel-plated brass	
-	Connecting thread	VA	Wrought aluminium alloy
		PI, VI	Anodised wrought aluminium alloy
-	Jet nozzle	Wrought aluminium alloy	
-	Female nozzle	POM	
-	Seals	NBR	
Note on materials		RoHS-compliant	
			Contains paint-wetting impairment substances

Datasheet

Vacuum p_u as a function of operating pressure p_1

High vacuum

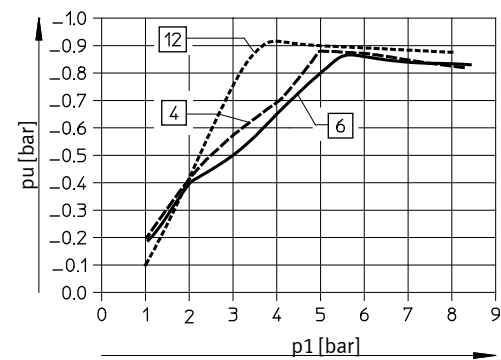
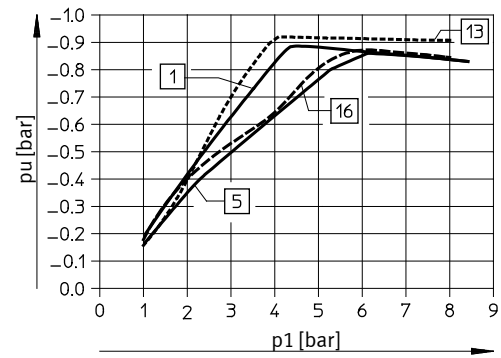

High suction rate

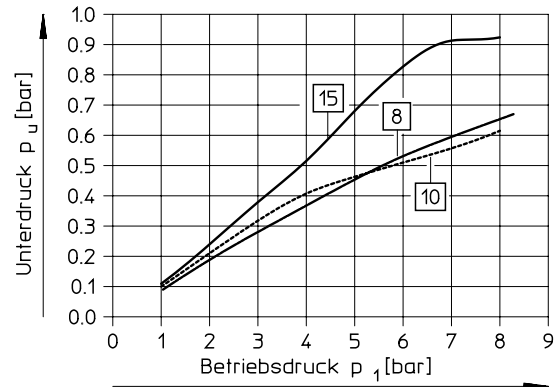
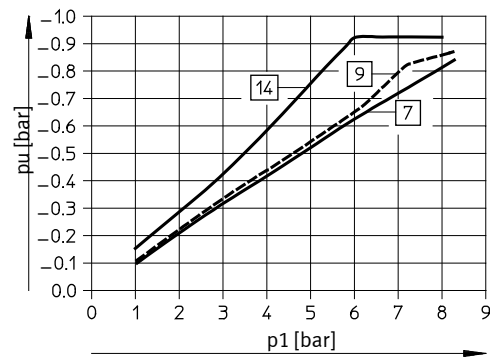

Standard:

- [1] VN-05-H-...
- VN-07-H-...
- VN-10-H-...
- [4] VN-14-H-...
- [12] VN-20-H-...
- [13] VN-30-H-...

Inline:

- [5] VN-05-M-...
- [6] VN-07-M-...
- [16] VN-10-M-...

Standard:

- [7] VN-05-L-...
- [8] VN-07-L-...
- [9] VN-10-L-...
- [10] VN-14-L-...
- [14] VN-20-L-...
- [15] VN-30-L-...

Inline:

- [8] VN-05-N-...

Datasheet

Evacuation time t as a function of vacuum p_u for 1 l volume at 6 bar operating pressure

High vacuum

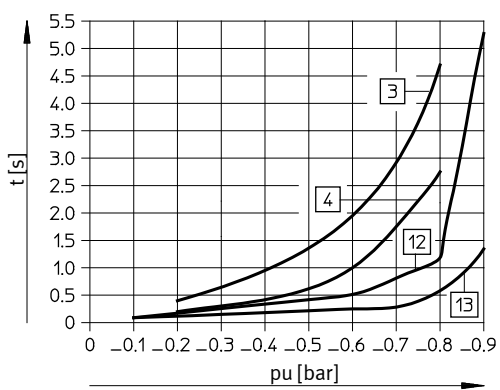
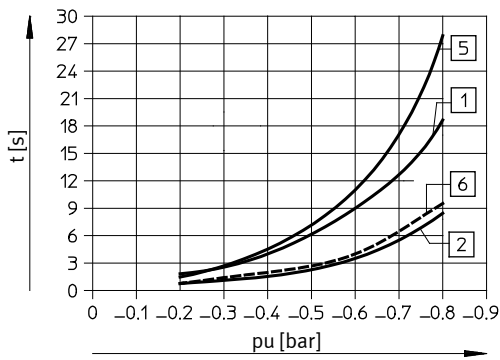

High suction rate

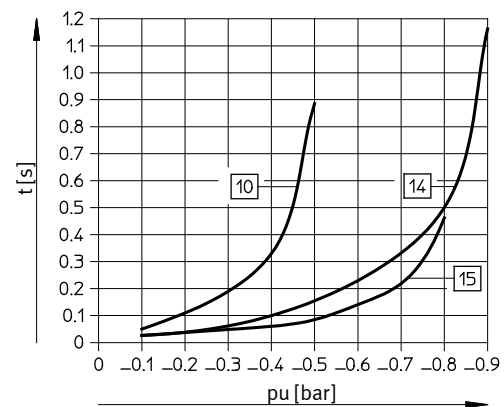
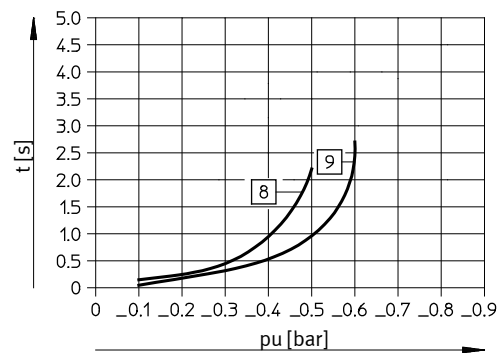
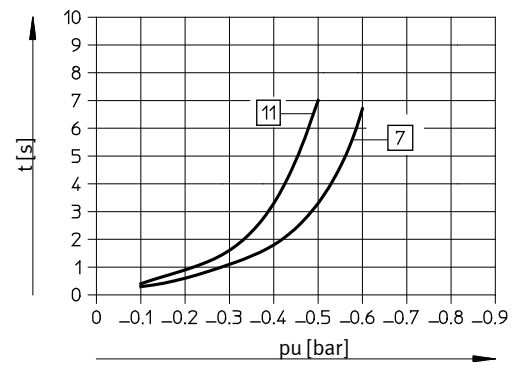

Standard:

- [1] VN-05-H-...
- [2] VN-07-H-...
- [3] VN-10-H-...
- [4] VN-14-H-...
- [12] VN-20-H-...
- [13] VN-30-H-...

Inline:

- [5] VN-05-M-...
- [6] VN-07-M-...
- [3] VN-10-M-...

Standard:

- [7] VN-05-L-...
- [8] VN-07-L-...
- [9] VN-10-L-...
- [10] VN-14-L-...
- [14] VN-20-L-...
- [15] VN-30-L-...

Inline:

- [11] VN-05-N-...

Datasheet

Suction rate q_{ns} (with respect to atmosphere) as a function of operating pressure p_1

High vacuum

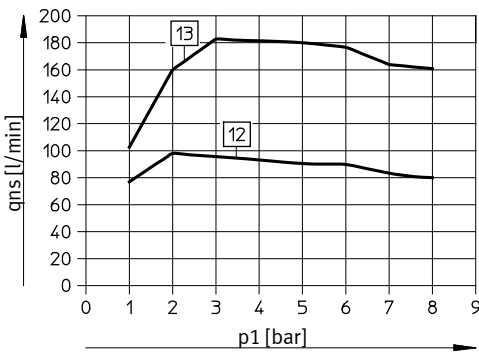
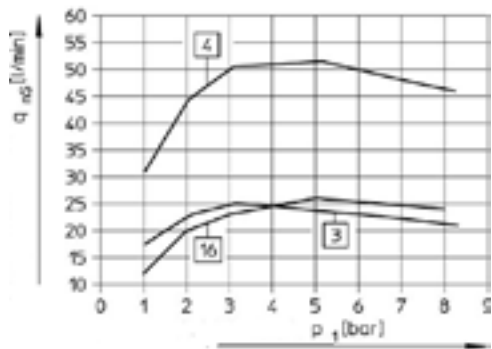
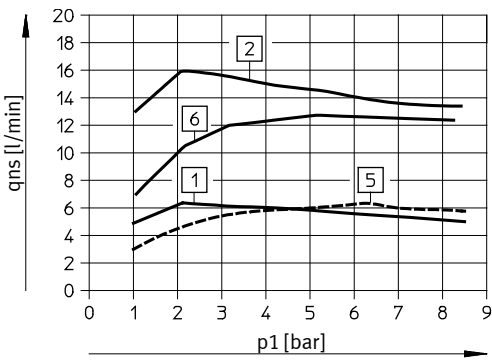

Standard:

- [1] VN-05-H-...
- [2] VN-07-H-...
- [3] VN-10-H-...
- [4] VN-14-H-...
- [12] VN-20-H-...
- [13] VN-30-H-...

Inline:

- [5] VN-05-M-...
- [6] VN-07-M-...
- [16] VN-10-M-...

High suction rate

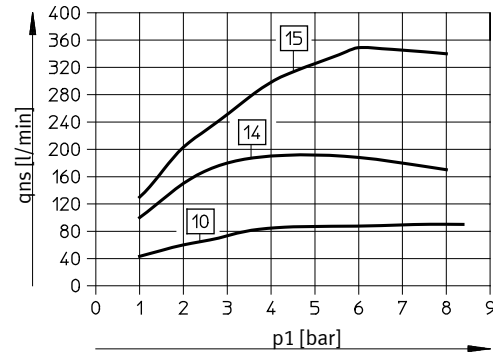
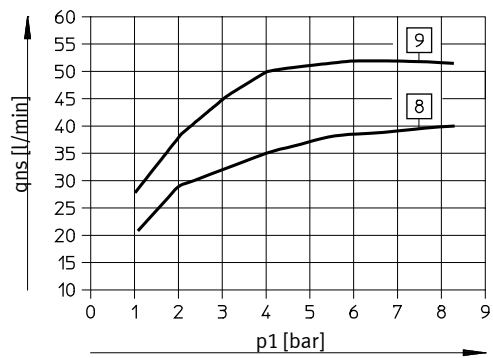
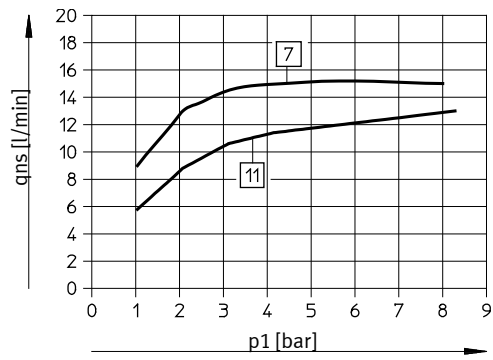

Standard:

- [7] VN-05-L-...
- [8] VN-07-L-...
- [9] VN-10-L-...
- [10] VN-14-L-...
- [14] VN-20-L-...
- [15] VN-30-L-...

Inline:

- [11] VN-05-N-...

Datasheet

Air consumption q_n as a function of operating pressure p_1

High vacuum/high suction rate

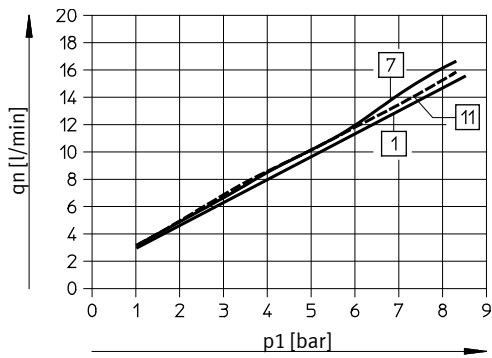

Standard:

[1] VN-05-H-...

[7] VN-05-L-...

Inline:

[1] VN-05-M-...

[11] VN-05-N-...

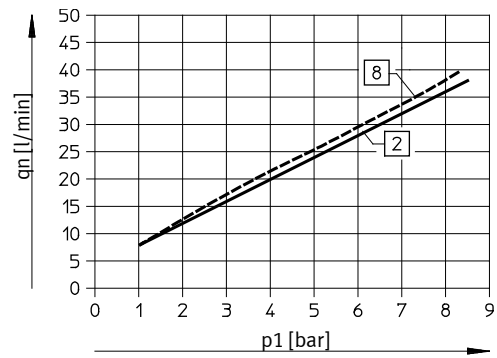

Standard:

[2] VN-07-H-...

[8] VN-07-L-...

Inline:

[2] VN-07-M-...

[8] VN-07-N-...

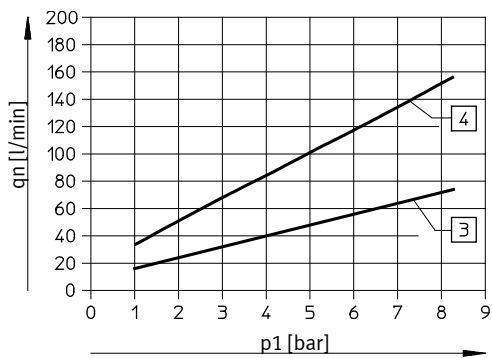

Standard:

[3] VN-10-H-...

VN-10-L-...

[4] VN-14-H-...

VN-14-L-...

Inline:

[3] VN-10-M-...

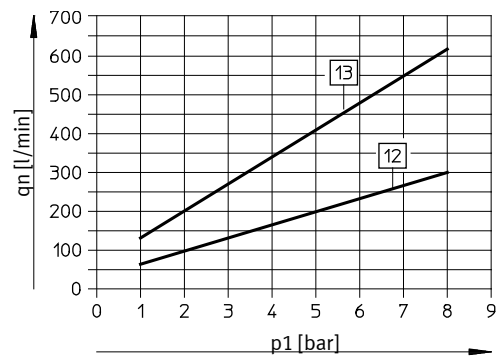

Standard:

[12] VN-20-H-...

VN-20-L-...

[13] VN-30-H-...

VN-30-L-...

Datasheet

Dimensions – T-shape/standard, VN-05/07/10/14

Download CAD data → www.festo.com

VN-...T...-PQ...-VQ...-RQ...

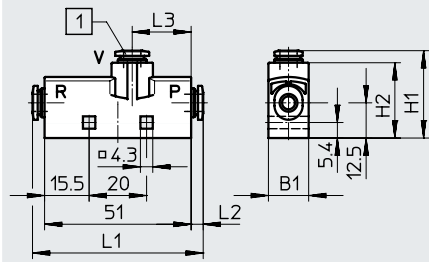

[1] Push-in fitting

VN-...T...-PQ...-VQ...-RO...

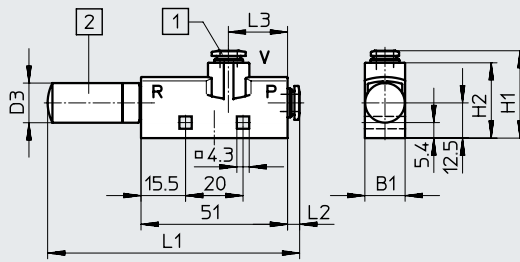

[1] Push-in fitting

[2] Silencer

VN-...T...-PQ...-VA...-RQ...

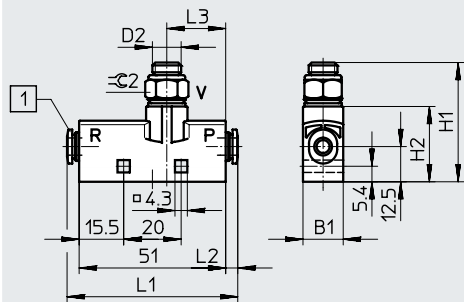

[1] Push-in fitting

VN-...T...-PQ...-VA...-RO...

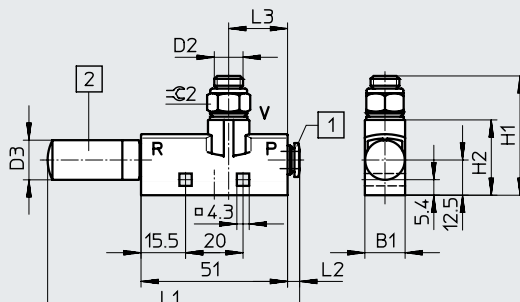

[1] Push-in fitting

[2] Silencer

VN-...T...-PI...-VI...-RI...

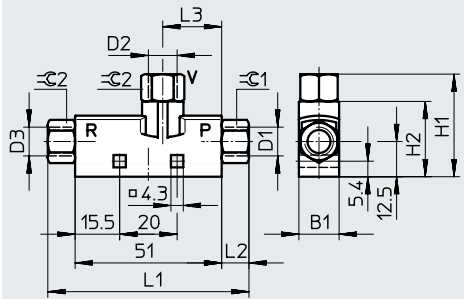

VN-...T...-PI...-VI...-RO...

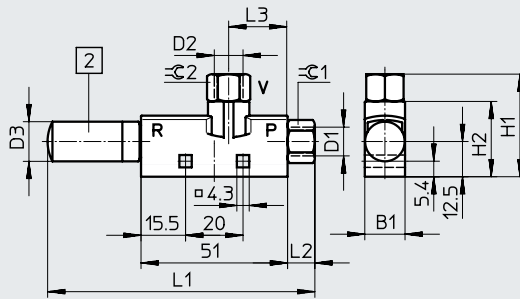

[2] Silencer

Type	B1	Connections			H1	H2	L1	L2	L3	⌀1	⌀2
		P D1	V D2	R D3							
VN-...T2-PQ1-VQ1-RQ1	10	QS-4	QS-4	QS-4	31.3	27.7	58.2	3.6	24.3	-	-
VN-...T2-PQ1-VQ1-RO1				9.8 ¹⁾			86.8				
VN-...T2-PI2-VI2-RI2		M5	M5	M5	61		9	9			
VN-...T2-PI2-VI2-RO1				9.8 ¹⁾	88.2						
VN-...T3-PQ2-VQ2-RQ2	14	QS-6	QS-6	QS-6	30.4	26.2	59.4	4.2	25.5	-	-
VN-...T3-PQ2-VQ2-RO1				13.8 ¹⁾			97.6				
VN-...T3-PQ2-VA4-RQ2				G1/8			G1/8				
VN-...T3-PQ2-VA4-RO1		13.8 ¹⁾	97.6								
VN-...T3-PI4-VI4-RI4		G1/8	G1/8		G1/8			70			
VN-...T3-PI4-VI4-RO1				13.8 ¹⁾	102.9						
VN-...T4-PQ2-VQ3-RQ3	18	QS-6	QS-8	QS-8	35.9	30.7	63.8	4.2	25.5	-	-
VN-...T4-PQ2-VQ3-RO2				17.8 ¹⁾			125.5				
VN-...T4-PQ2-VA5-RQ3				G1/4			G1/4				
VN-...T4-PQ2-VA5-RO2		17.8 ¹⁾	125.5								
VN-...T4-PI4-VI5-RI5		G1/8	G1/4		G1/4			81.4			
VN-...T4-PI4-VI5-RO2				17.8 ¹⁾	128.8						

1) Diameter of silencer - † - Note: This product corresponds to ISO 1179-1 and ISO 228-1.

Datasheet

Dimensions – T-shape/standard, VN-10

Download CAD data → www.festo.com

VN-10-LT3-PI4-VA4-R01

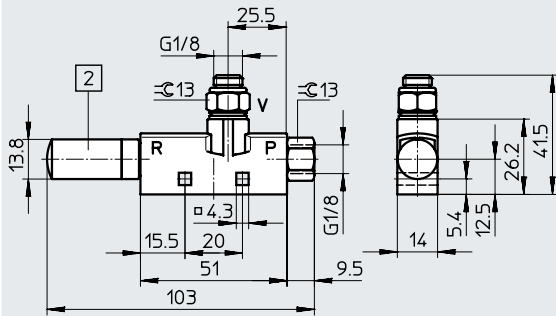

[2] Silencer



Note:

This product conforms to ISO 1179-1 and ISO 228-1.

Dimensions – T-shape/standard, VN-20/30

Download CAD data → www.festo.com

VN-...-T6-PQ4-VQ5-R02

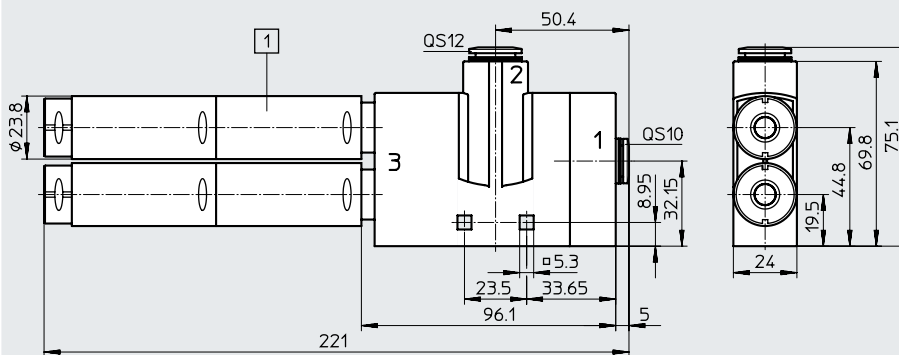

[1] Silencer

VN-...-T6-PQ4-VA5-R02

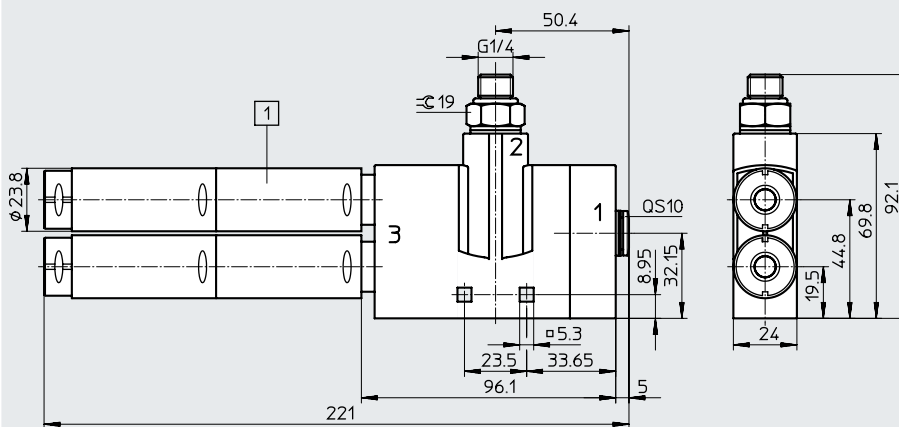

[1] Silencer



Note:

This product conforms to ISO 1179-1 and ISO 228-1.

VN-...-T6-PI5-VI6-R02

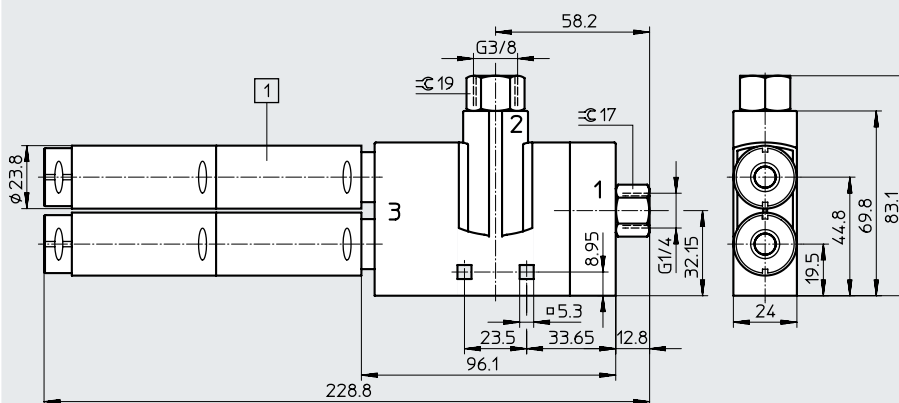

[1] Silencer



Note:

This product conforms to ISO 1179-1 and ISO 228-1.

Datasheet

Dimensions – T-shape/inline, VN-05/07

Download CAD data → www.festo.com

VN-...T...-PQ...-VQ...-RQ...

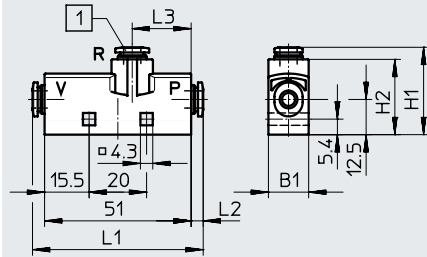

[1] Push-in fitting

VN-...T...-PQ...-VQ...-R01

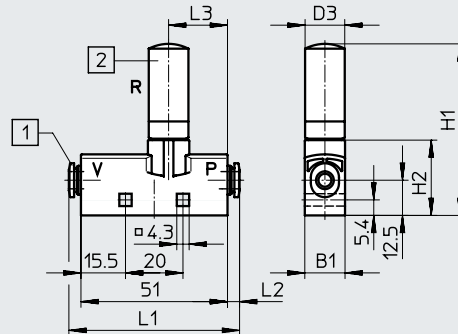

[1] Push-in fitting

[2] Silencer

VN-...T...-PI...-VI...-RI...

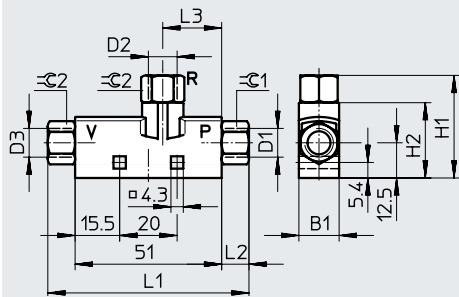

VN-...T...-PI...-VI...-R01

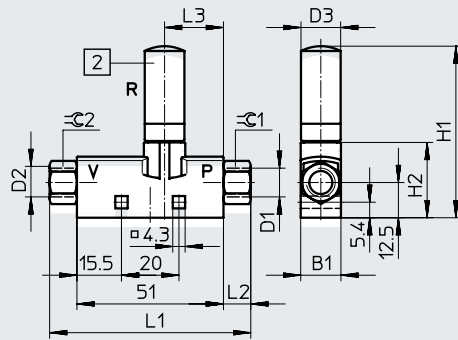

[2] Silencer

Type	B1	Connections			H1	H2	L1	L2	L3	∅G1	∅G2
		P D1	V D2	R D3							
VN-...T2-PQ1-VQ1-RQ1	10	QS-4	QS-4	QS-4	31.3	27.7	58.2	3.6	24.3	-	-
VN-...T2-PQ1-VQ1-R01				9.8 ¹⁾	59.9						
VN-...T2-PI2-VI2-RI2		M5	M5	M5	32.7						
VN-...T2-PI2-VI2-R01				9.8 ¹⁾	59.9						
VN-...T3-PQ2-VQ2-RQ2	14	QS-6	QS-6	QS-6	30.4	26.2	59.4	4.2	25.5	-	-
VN-...T3-PQ2-VQ2-R01				13.8 ¹⁾	68.6						
VN-...T3-PI4-VI4-RI4		G1/8	G1/8	G1/8	35.7						
VN-...T3-PI4-VI4-R01				13.8 ¹⁾	68.6						

1) Diameter of silencer

Note: This product corresponds to ISO 1179-1 and ISO 228-1.

Dimensions – Straight shape/inline, VN-05/07/10

Download CAD data → www.festo.com

VN-05/07-...-I...-PQ...-VQ...

VN-10-M-I3-PQ2-VQ2

VN-05/07-...-I...-PQ...-VT...

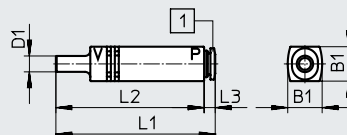
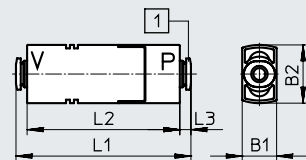
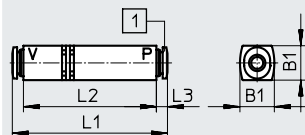

[1] Push-in fitting

Type	B1	B2	Connections		D1 ∅	L1	L2	L3
			P	V				
VN-05/07-...-I2-PQ1-VQ1	10	-	QS-4	QS-4	-	57.4	50.2	3.6
VN-05/07-...-I2-PQ1-VT1				-	4	61.6	58	
VN-05/07-...-I3-PQ2-VQ2	13	-	QS-6	QS-6	-	58.6	50.2	4.2
VN-10-M-I3-PQ2-VQ2		22				66.1	57.7	
VN-05/07-...-I3-PQ2-VT2		-				60.2	56	

Datasheet

★ Core Range

Ordering data and weights – Standard							
T-shape							
Grid dimension [mm]	Nominal width of Laval nozzle [mm]	Weight [g]	High vacuum H		Weight [g]	High suction rate L	
			Part no.	Type		Part no.	Type
With push-in fitting							
14	0.95	22	★ 193480	VN-10-H-T3-PQ2-VQ2-RQ2	–	–	–
18	1.4	–	–	–	27	★ 193565	VN-14-L-T4-PQ2-VQ3-RQ3
Via female thread							
14	0.95	22	★ 193500	VN-10-H-T3-PI4-VI4-RI4	–	–	–
18	1.4	36	★ 193502	VN-14-H-T4-PI4-VI5-RI5	–	–	–

Ordering data and weights – Inline							
Straight shape							
Grid dimension [mm]	Nominal width of Laval nozzle [mm]	Weight [g]	High vacuum M		Weight [g]	High suction rate N	
			Part no.	Type		Part no.	Type
With push-in fitting							
13	0.7	16	★ 193553	VN-07-M-I3-PQ2-VQ2	–	–	–
With push-in fitting and push-in sleeve							
13	0.7	12	★ 193556	VN-07-M-I3-PQ2-VT2	–	–	–

Ordering data and weights – Standard							
T-shape							
Grid dimension [mm]	Nominal width of Laval nozzle [mm]	Weight [g]	High vacuum H		Weight [g]	High suction rate L	
			Part no.	Type		Part no.	Type
With push-in fitting							
10	0.45	15	526100	VN-05-H-T2-PQ1-VQ1-RQ1	15	526114	VN-05-L-T2-PQ1-VQ1-RQ1
	0.7	15	526101	VN-07-H-T2-PQ1-VQ1-RQ1	–	–	–
14	0.45	22	193478	VN-05-H-T3-PQ2-VQ2-RQ2	22	193561	VN-05-L-T3-PQ2-VQ2-RQ2
	0.7	22	193479	VN-07-H-T3-PQ2-VQ2-RQ2	22	193562	VN-07-L-T3-PQ2-VQ2-RQ2
	0.95	–	–	–	22	193563	VN-10-L-T3-PQ2-VQ2-RQ2
18	0.95	27	526147	VN-10-H-T4-PQ2-VQ3-RQ3	27	526157	VN-10-L-T4-PQ2-VQ3-RQ3
	1.4	27	193482	VN-14-H-T4-PQ2-VQ3-RQ3	–	–	–
With push-in fitting and silencer							
10	0.45	15	193569	VN-05-H-T2-PQ1-VQ1-RO1	15	193595	VN-05-L-T2-PQ1-VQ1-RO1
	0.7	15	193570	VN-07-H-T2-PQ1-VQ1-RO1	–	–	–
14	0.45	24	193488	VN-05-H-T3-PQ2-VQ2-RO1	24	193571	VN-05-L-T3-PQ2-VQ2-RO1
	0.7	24	193489	VN-07-H-T3-PQ2-VQ2-RO1	24	193572	VN-07-L-T3-PQ2-VQ2-RO1
	0.95	24	193490	VN-10-H-T3-PQ2-VQ2-RO1	24	193573	VN-10-L-T3-PQ2-VQ2-RO1
18	0.95	36	549251	VN-10-H-T4-PQ2-VQ3-RO2	36	549253	VN-10-L-T4-PQ2-VQ3-RO2
	1.4	36	547707	VN-14-H-T4-PQ2-VQ3-RO2	36	547710	VN-14-L-T4-PQ2-VQ3-RO2
24	2.0	182	193495	VN-20-H-T6-PQ4-VQ5-RO2	182	193578	VN-20-L-T6-PQ4-VQ5-RO2
	3.0	182	193497	VN-30-H-T6-PQ4-VQ5-RO2	–	–	–

Datasheet

Ordering data and weights – Standard

T-shape							
Grid dimension [mm]	Nominal width of Laval nozzle [mm]	Weight [g]	High vacuum H		Weight [g]	High suction rate L	
			Part no.	Type		Part no.	Type
With push-in fitting, vacuum port male thread							
14	0.45	24	193516	VN-05-H-T3-PQ2-VA4-RQ2	24	193599	VN-05-L-T3-PQ2-VA4-RQ2
	0.7	24	193517	VN-07-H-T3-PQ2-VA4-RQ2	24	193600	VN-07-L-T3-PQ2-VA4-RQ2
	0.95	24	193518	VN-10-H-T3-PQ2-VA4-RQ2	24	193601	VN-10-L-T3-PQ2-VA4-RQ2
18	0.95	33	526153	VN-10-H-T4-PQ2-VA5-RQ3	33	526163	VN-10-L-T4-PQ2-VA5-RQ3
	1.4	33	193520	VN-14-H-T4-PQ2-VA5-RQ3	33	193603	VN-14-L-T4-PQ2-VA5-RQ3
With push-in fitting, vacuum port male thread and silencer							
14	0.45	26	193526	VN-05-H-T3-PQ2-VA4-RO1	26	193609	VN-05-L-T3-PQ2-VA4-RO1
	0.7	26	193527	VN-07-H-T3-PQ2-VA4-RO1	26	193610	VN-07-L-T3-PQ2-VA4-RO1
	0.95	26	193528	VN-10-H-T3-PQ2-VA4-RO1	26	193611	VN-10-L-T3-PQ2-VA4-RO1
18	0.95	42	549252	VN-10-H-T4-PQ2-VA5-RO2	42	549254	VN-10-L-T4-PQ2-VA5-RO2
	1.4	42	547706	VN-14-H-T4-PQ2-VA5-RO2	42	547709	VN-14-L-T4-PQ2-VA5-RO2
24	2.0	189	526145	VN-20-H-T6-PQ4-VA5-RO2	189	526135	VN-20-L-T6-PQ4-VA5-RO2
	3.0	189	526146	VN-30-H-T6-PQ4-VA5-RO2	189	526136	VN-30-L-T6-PQ4-VA5-RO2
Via female thread							
10	0.45	13	526102	VN-05-H-T2-PI2-VI2-RI2	13	526116	VN-05-L-T2-PI2-VI2-RI2
	0.7	13	526103	VN-07-H-T2-PI2-VI2-RI2	–	–	–
14	0.45	22	193498	VN-05-H-T3-PI4-VI4-RI4	22	193581	VN-05-L-T3-PI4-VI4-RI4
	0.7	22	193499	VN-07-H-T3-PI4-VI4-RI4	22	193582	VN-07-L-T3-PI4-VI4-RI4
	0.95	–	–	–	22	193583	VN-10-L-T3-PI4-VI4-RI4
18	1.4	–	–	–	36	193585	VN-14-L-T4-PI4-VI5-RI5
With female thread and silencer							
10	0.45	13	526104	VN-05-H-T2-PI2-VI2-RO1	13	526118	VN-05-L-T2-PI2-VI2-RO1
	0.7	13	526105	VN-07-H-T2-PI2-VI2-RO1	–	–	–
14	0.45	24	193507	VN-05-H-T3-PI4-VI4-RO1	24	193590	VN-05-L-T3-PI4-VI4-RO1
	0.7	24	193508	VN-07-H-T3-PI4-VI4-RO1	24	193591	VN-07-L-T3-PI4-VI4-RO1
	0.95	24	193509	VN-10-H-T3-PI4-VI4-RO1	24	193592	VN-10-L-T3-PI4-VI4-RO1
18	1.4	40	547705	VN-14-H-T4-PI4-VI5-RO2	40	547708	VN-14-L-T4-PI4-VI5-RO2
24	2.0	183	526141	VN-20-H-T6-PI5-VI6-RO2	183	526131	VN-20-L-T6-PI5-VI6-RO2
	3.0	183	526142	VN-30-H-T6-PI5-VI6-RO2	183	526132	VN-30-L-T6-PI5-VI6-RO2
With female thread, vacuum port male thread and silencer							
14	0.95	–	–	–	26	543315	VN-10-L-T3-PI4-VA4-RO1

Datasheet

Ordering data and weights – Inline							
T-shape							
Grid dimension [mm]	Nominal width of Laval nozzle [mm]	Weight [g]	High vacuum M		Weight [g]	High suction rate N	
			Part no.	Type		Part no.	Type
With push-in fitting							
10	0.45	15	526106	VN-05-M-T2-PQ1-VQ1-RQ1	–	–	–
	0.7	15	526107	VN-07-M-T2-PQ1-VQ1-RQ1			
14	0.45	22	193536	VN-05-M-T3-PQ2-VQ2-RQ2	22	193619	VN-05-N-T3-PQ2-VQ2-RQ2
	0.7	22	193537	VN-07-M-T3-PQ2-VQ2-RQ2	–	–	–
With push-in fitting and silencer							
10	0.45	15	526108	VN-05-M-T2-PQ1-VQ1-R01	–	–	–
	0.7	15	526109	VN-07-M-T2-PQ1-VQ1-R01			
14	0.45	24	193540	VN-05-M-T3-PQ2-VQ2-R01	24	193623	VN-05-N-T3-PQ2-VQ2-R01
	0.7	24	193541	VN-07-M-T3-PQ2-VQ2-R01	–	–	–
Via female thread							
10	0.45	13	526110	VN-05-M-T2-PI2-VI2-RI2	–	–	–
	0.7	13	526111	VN-07-M-T2-PI2-VI2-RI2			
14	0.45	22	193544	VN-05-M-T3-PI4-VI4-RI4	22	193627	VN-05-N-T3-PI4-VI4-RI4
	0.7	22	193545	VN-07-M-T3-PI4-VI4-RI4	–	–	–
With female thread and silencer							
10	0.45	13	526112	VN-05-M-T2-PI2-VI2-R01	–	–	–
	0.7	13	526113	VN-07-M-T2-PI2-VI2-R01			
14	0.45	24	193548	VN-05-M-T3-PI4-VI4-R01	24	193631	VN-05-N-T3-PI4-VI4-R01
	0.7	24	193549	VN-07-M-T3-PI4-VI4-R01	–	–	–
Ordering data and weights – Inline							
Straight shape							
Grid dimension [mm]	Nominal width of Laval nozzle [mm]	Weight [g]	High vacuum M		Weight [g]	High suction rate N	
			Part no.	Type		Part no.	Type
With push-in fitting							
10	0.45	11	193580	VN-05-M-I2-PQ1-VQ1	–	–	–
	0.7	11	193586	VN-07-M-I2-PQ1-VQ1			
13	0.45	16	193552	VN-05-M-I3-PQ2-VQ2	16	193635	VN-05-N-I3-PQ2-VQ2
	0.95	23	193554	VN-10-M-I3-PQ2-VQ2	–	–	–
With push-in fitting and push-in sleeve							
10	0.45	8	193587	VN-05-M-I2-PQ1-VT1	–	–	–
	0.7	8	193588	VN-07-M-I2-PQ1-VT1			
13	0.45	12	193555	VN-05-M-I3-PQ2-VT2	12	193637	VN-05-N-I3-PQ2-VT2

Peripherals overview

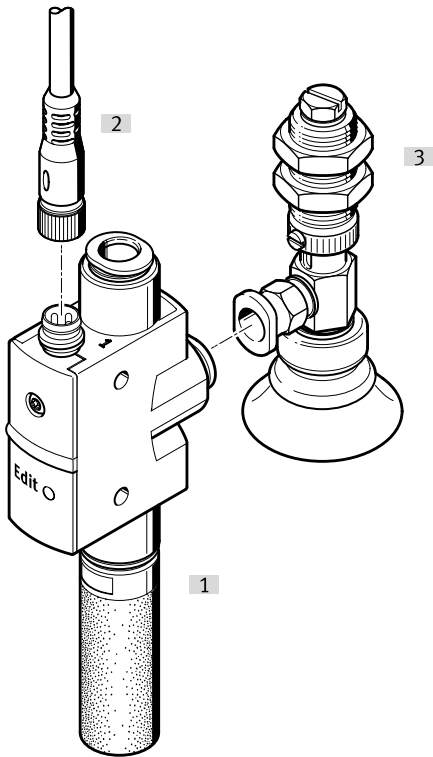

Peripherals overview

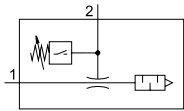

Mounting attachments and accessories		→ Page/ Internet
[1]	Vacuum generators VN-P	26
[2]	Plug socket with cable, 3-pin NEBU-M8	47
[3]	Suction gripper ESG	esg
-	Suction cup holder ESH	esh
-	Suction cup ESS	ess

Datasheet

 Function
Standard

-  - Temperature range
0 ... +60°C
-  - Operating pressure
0.1 ... 0.8 MPa



- Threshold value comparator with fixed or variable hysteresis
- Teach-in setting option for threshold value and hysteresis

General technical data		T-shape		
Type		VN-05	VN-07	VN-10
Grid dimension	[mm]	16	16	16
Nominal width of Laval nozzle	[mm]	0.45	0.7	0.95
Ejector characteristic		High vacuum/standard H High suction rate/standard L		
Integrated function		Pressure sensor Open silencer		
Pneumatic connection 1		QS-6		
Vacuum connection		QS-6		
Pneumatic connection 3		Open silencer		
Measured variable		Relative pressure		
Measuring principle		Piezoresistive		
Pressure measuring range	[kPa]	-100 ... 0		
	[bar]	-1 ... 0		
	[psi]	-14.5 ... 0		
Type of mounting (max. tightening torque)		With through-hole (0.6 Nm)		
Mounting position		Any ¹⁾		
Cleaning recommendation		Soapy water		
Product weight	[g]	33	36	36

1) It should not be possible for condensed water to collect in the sensor.

Operating and environmental conditions		
Operating pressure	[MPa]	0.1 ... 0.8
	[bar]	1 ... 8
	[psi]	14.5 ... 116
Nominal operating pressure	[MPa]	0.6
	[bar]	6
	[psi]	87
Operating medium		Compressed air to ISO 8573-1:2010 [7:4:4]
Note on the operating/pilot medium		Lubricated operation not possible
Ambient temperature	[°C]	0 ... +50
Temperature of medium	[°C]	0 ... +60
Corrosion resistance class CRC ¹⁾		1 - Low corrosion stress
CE marking (see declaration of conformity) ²⁾		To EU EMC Directive
UKCA marking (see declaration of conformity) ²⁾		To UK EMC regulations
Certification		RCM
KC marking		KC EMC

1) Corrosion resistance class CRC 1 to Festo standard FN 940070

Low corrosion stress. Dry internal application or transport and storage protection. Also applies to parts behind covers, in the non-visible interior area, or parts that are covered in the application (e.g. drive trunnions).

2) www.festo.com/catalogue/vn → Support/Downloads.

If the devices are subject to usage restrictions in residential, commercial or light-industrial environments, further measures for the reduction of the emitted interference may be necessary.

Vacuum generators VN-P, with integrated vacuum switch

Datasheet

Performance data		High vacuum/standard H			High suction rate/standard L		
Ejector characteristic							
Nominal width of Laval nozzle	[mm]	0.45	0.7	0.95	0.45	0.7	0.95
Max. vacuum	[%]	92	92	93	–	–	–
Operating pressure for max. vacuum	[MPa]	0.49	0.44	0.35	–	–	–
	[bar]	4.9	4.4	3.5	–	–	–
	[psi]	71.05	63.8	50.75	–	–	–
Max. suction rate with respect to atmosphere	[l/min]	7.2	16.2	21.8	13.6	30.9	41.5
Operating pressure for max. suction rate	[MPa]	0.3	0.3	0.3	0.5	0.4	0.5
	[bar]	3	3	3	5	4	5
	[psi]	43.5	43.5	43.5	72.5	58	72.5
Noise level at nominal operating pressure 6 bar	[dB (A)]	62	66	70	54	63	66

Electrical data		
Operating voltage range	[V DC]	15 ... 30
Residual ripple	[%]	10
Electrical connection		M8x1, 3-pin
Switch-on/switch-off time	[ms]	≤ 4
Switching output		PNP
Max. output current	[mA]	100
Residual current	[mA]	≤ 0.3
Voltage drop	[V]	≤ 1.5
Switching element function		N/O
Setting options		Teach-in
Switching function		Threshold value comparator with fixed hysteresis
		Threshold value comparator with variable hysteresis
Threshold-value setting range	[kPa]	–100 ... 0
	[bar]	–1 ... 0
	[psi]	–14.5 ... 0
Accuracy	[% FS] ¹⁾	±1.5
Hysteresis	[% FS] ¹⁾	±2 (threshold value comparator with fixed hysteresis)
Long-term drift	[% FS] ¹⁾	max. ±0.5
Temperature coefficient of switching point	[%/K]	0.05
Display type/switching status indication		LED
Inductive protective circuit		Adapted to MZ, MY, ME coils
Short circuit current rating		Clocked
Reverse polarity protection		For all electrical connections
Overload protection		Available
Degree of protection		IP40 (to EN 60529)

1) % FS = % of measuring range end value (full scale)

Electrical outputs¹⁾

1 switching output PNP

1x M8 plug

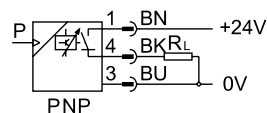

1 = +24 V
3 = 0 V
4 = Output A

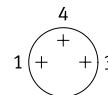

1) Wire colours as indicated apply when using plug sockets with cable NEBU-M8, 3-pin; datasheet → Internet: nebu-m8*3

Datasheet

Materials

Sectional view

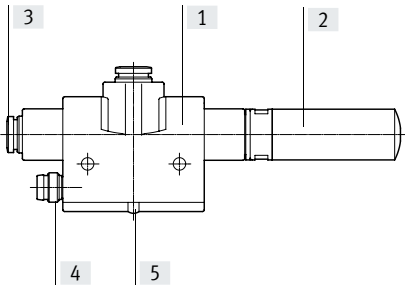

Vacuum generator		
[1]	Housing material	Reinforced POM
[2]	Silencer material	PE
[3]	Push-in fitting material	Nickel-plated brass
[4]	Plug housing material	PA, chrome- and nickel-plated brass
[5]	Fibre-optic cable material	PC
-	Jet nozzle material	Wrought aluminium alloy
-	Female nozzle material	POM
-	Keypad material	POM
-	Sealing material	NBR
LABS (PWIS) conformity		VDMA24364-B1/B2-L

Vacuum p_u as a function of operating pressure p_1

High vacuum/high suction rate

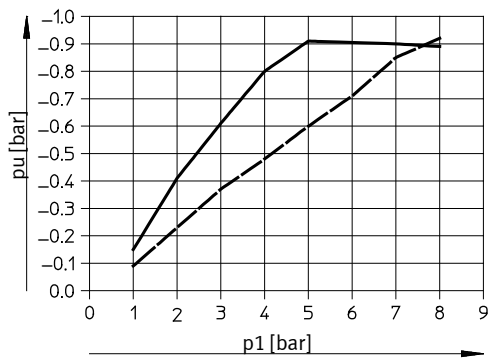

— VN-05-H
- - - VN-05-L

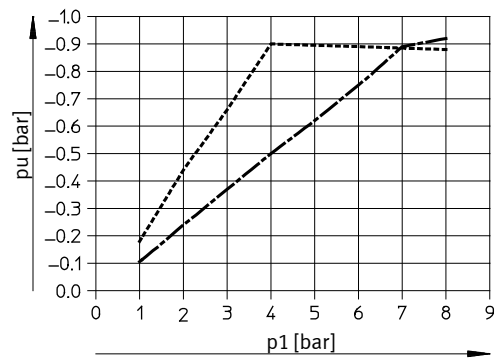

..... VN-07-H
- · - · - VN-07-L

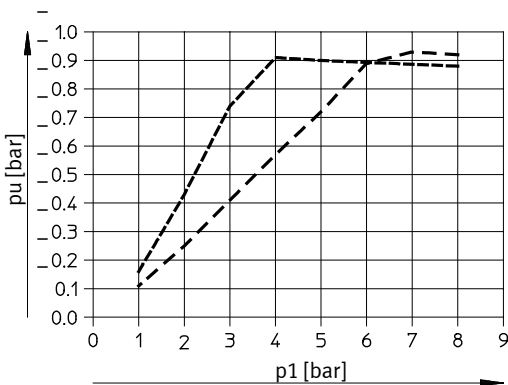

- - - - - VN-10-H
- - - - - VN-10-L

Datasheet

Evacuation time t as a function of vacuum p_u for 1 l volume at 6 bar operating pressure

High vacuum/high suction rate

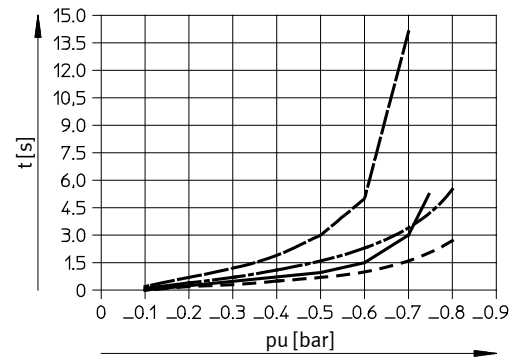
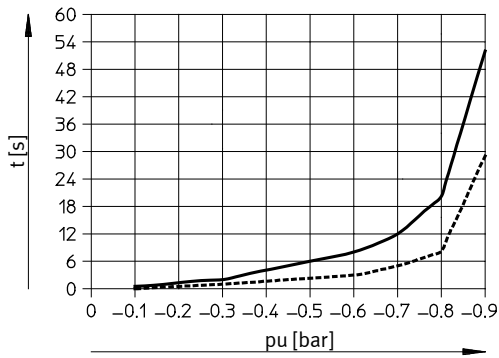

— VN-05-H
 VN-07-H

--- VN-05-L
 -.-.- VN-07-L
 — VN-10-H
 - - - VN-10-L

Suction rate q_{ns} (with respect to atmosphere) as a function of operating pressure p_1

High vacuum/high suction rate

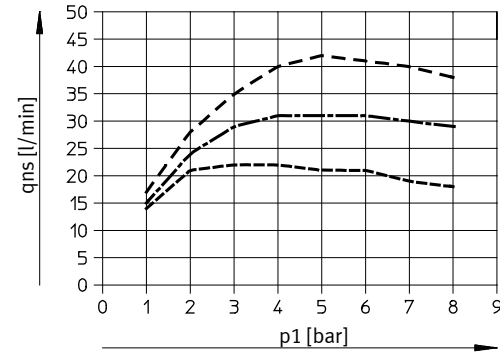
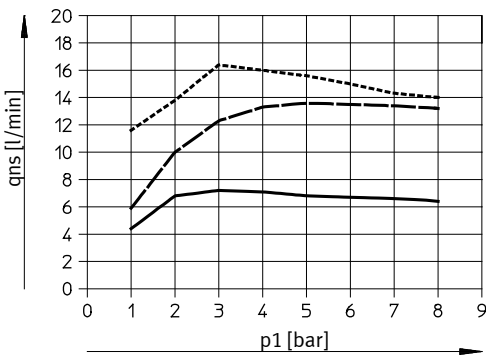

— VN-05-H
 --- VN-05-L
 VN-07-H

-.-.- VN-07-L
 - - - VN-10-H
 - - - VN-10-L

Air consumption q_n as a function of operating pressure p_1

High vacuum/high suction rate

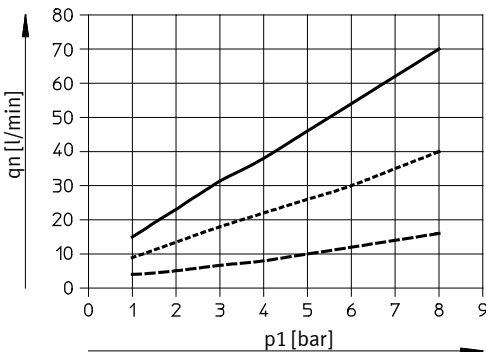

--- VN-05
 VN-07
 — VN-10

Datasheet

Dimensions

Download CAD data → www.festo.com

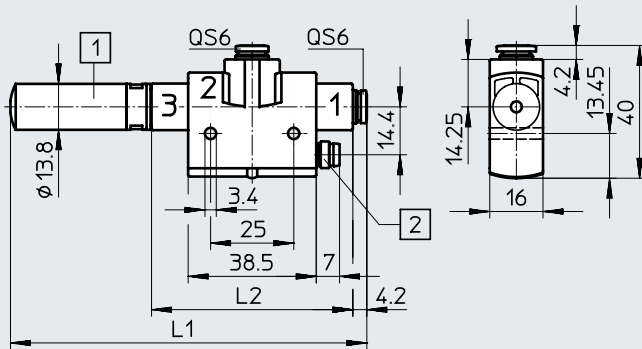

- [1] Silencer
- [2] M8x1, 3-pin

Type	L1	L2
VN-05	93.6	44.2
VN-07	107	60.5
VN-10		

Ordering data

With push-in fitting and silencer

Nominal width of Laval nozzle [mm]	Switching function		High vacuum/standard H		High suction rate/standard L	
	Threshold value with fixed hysteresis	Threshold value with variable hysteresis	Part no.	Type	Part no.	Type
0.45	■	–	536796	VN-05-H-T4-PQ2-VQ2-01-P	536798	VN-05-L-T4-PQ2-VQ2-01-P
	–	■	536797	VN-05-H-T4-PQ2-VQ2-02-P	536799	VN-05-L-T4-PQ2-VQ2-02-P
0.7	■	–	536800	VN-07-H-T4-PQ2-VQ2-01-P	536802	VN-07-L-T4-PQ2-VQ2-01-P
	–	■	536801	VN-07-H-T4-PQ2-VQ2-02-P	536803	VN-07-L-T4-PQ2-VQ2-02-P
0.95	■	–	536804	VN-10-H-T4-PQ2-VQ2-01-P	536806	VN-10-L-T4-PQ2-VQ2-01-P
	–	■	536805	VN-10-H-T4-PQ2-VQ2-02-P	536807	VN-10-L-T4-PQ2-VQ2-02-P

Peripherals overview

Straight shape VN-05/07-...-A	T-shape VN-05/07/10/14-...-A/M/B	VN-20/30-...-M
----------------------------------	-------------------------------------	----------------

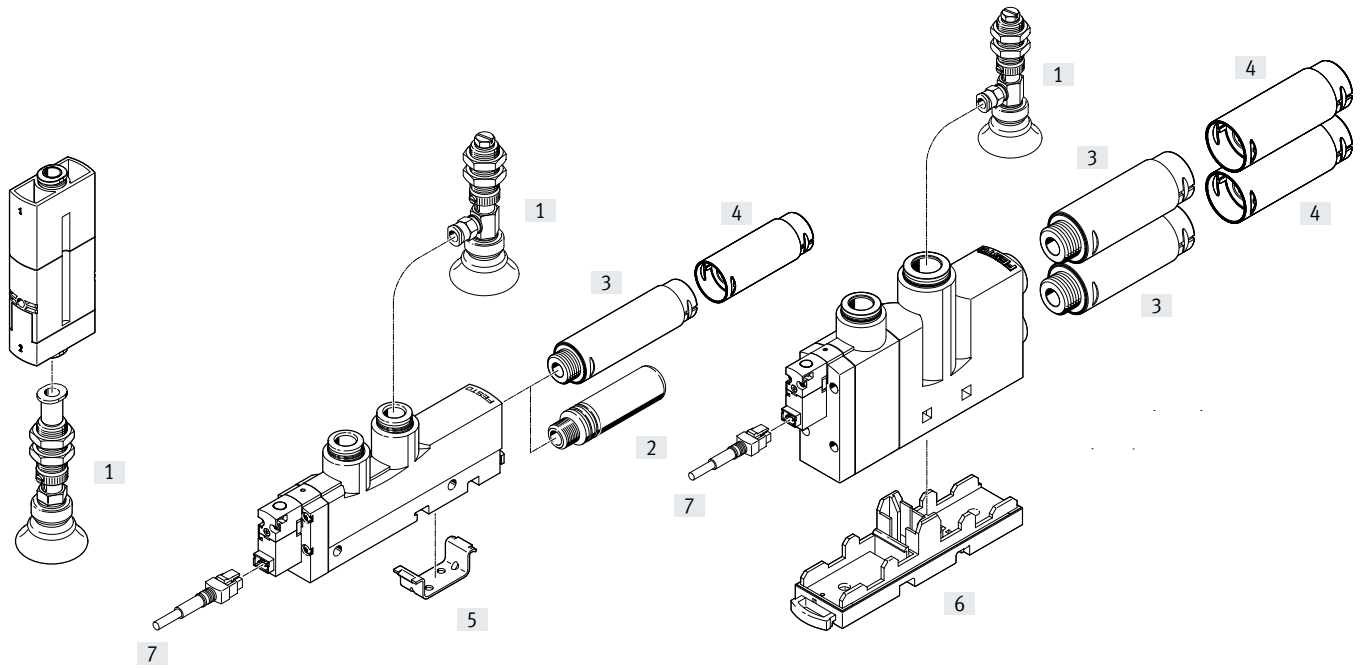

Mounting attachments and accessories		Straight shape		T-shape				→ Page/Internet			
		VN-05/07		VN-05/07/10		VN-14			VN-20/30		
		A		A	M	B	A		M	B	M
[1]	Suction gripper ESG	■		■				■			esg
[2]	Silencer UO	-		■				-			46
[3]	Silencer UOM	-		-				■			46
[4]	Silencer extension UOMS	-		-				■			46
[5]	Mounting plate VN-T3/T4-BP	-		■				■			45
[6]	Mounting plate VN-T6-BP-NRH	-		-				-		■	45
[7]	Plug socket with cable, 2-pin NEBV	-		-	■	■		-	■	■	47
-	Suction cup holder ESH	■		■				■			esh
-	Suction cup ESS	■		■				■			ess



Datasheet

Function

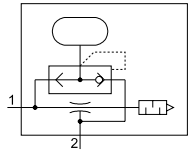
VN-A – Standard/inline
Ejector pulse, pneumatic





VN-A

-  - Temperature range
0 ... +60°C
-  - Operating pressure
1 ... 8 bar

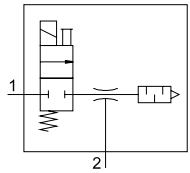
VN-M – Standard
On/off valve, electric



VN-M / VN-B

-  - Temperature range
0 ... +50°C
-  - Operating pressure
2 ... 8 bar

VN-B – Standard
On/off valve, electric,
ejector pulse, pneumatic

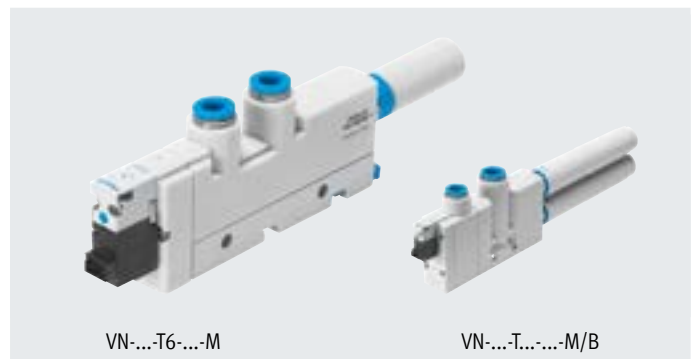
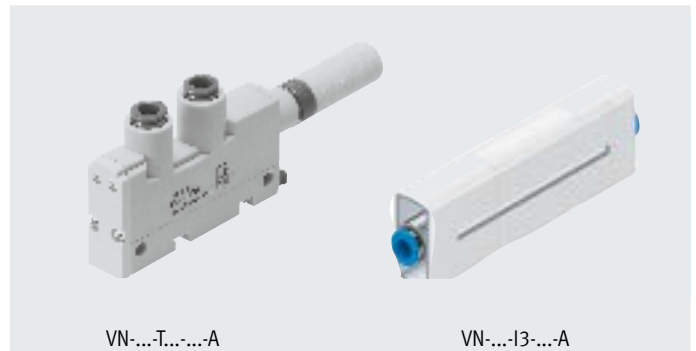
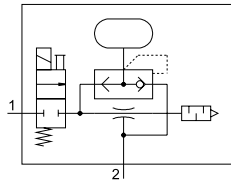

General technical data – Standard																
Design		T-shape														
Type		VN-05			VN-07			VN-10			VN-14			VN-20		VN-30
Grid dimension [mm]		14			14			14			18			24		24
Integrated function		A	M	B	A	M	B	A	M	B	A	M	B	M	M	
Nominal width of Laval nozzle [mm]		0.45			0.7			0.95			1.4			2.0		3.0
Ejector characteristic		High vacuum/standard H														
		High suction rate/standard L														
Pneumatic connection 1		–														
Push-in fitting		QS-6	QS-6	QS-6	QS-6	QS-6	QS-6	QS-6	QS-6	QS-6	QS-6	QS-6	QS-6	QS-6	QS-6	
Female thread		G1/8	–	–	G1/8	–	–	G1/8	–	–	G1/8	–	–	G1/4	–	
Vacuum connection		–														
Push-in fitting		QS-6	QS-6	QS-6	QS-6	QS-6	QS-6	QS-6	QS-6	QS-6	QS-6	QS-6	QS-6	QS-6	QS-6	
Female thread		G1/8	–	–	G1/8	–	–	G1/8	–	–	G1/8	–	–	G1/4	–	
Pneumatic connection 3		Open silencer														
Type of mounting (max. tightening torque)		With through-hole (0.5 Nm)														
		With through-hole (0.8 Nm)														
		With H-rail														
		Via accessories														
Mounting position		Any														
Cleaning recommendation		Soapy water														

• Note: This product corresponds to ISO 1179-1 and ISO 228-1.

Datasheet

General technical data – Inline		
Design	Straight shape	
Type	VN-05	VN-07
Grid dimension [mm]	14.5	14.5
Integrated function	A	A
Nominal width of Laval nozzle [mm]	0.45	0.7
Ejector characteristic	High vacuum/inline M High suction rate/inline N	
Pneumatic connection 1	QS-6	
Vacuum connection	QS-6	
Type of mounting	In-line installation	
Mounting position	Any	
Cleaning recommendation	Soapy water	

Operating and environmental conditions				
Pneumatic connection	With push-in fitting			Via female thread
Integrated function	A	M	B	A
Operating pressure [bar]	1 ... 8	2 ... 8		1 ... 8
Nominal operating pressure [bar]	6			
Operating medium	Compressed air to ISO 8573-1:2010 [7:4:4]			
Note on the operating/pilot medium	Lubricated operation not possible			
Ambient temperature [°C]	0 ... +60	0 ... +50		0 ... +60
Temperature of medium [°C]	0 ... +60	0 ... +50		0 ... +60
Corrosion resistance class CRC ¹⁾	1			2

- 1) Corrosion resistance class CRC 1 to Festo standard FN 940070
 Low corrosion stress. Dry internal application or transport and storage protection. Also applies to parts behind covers, in the non-visible interior area, or parts that are covered in the application (e.g. drive trunnions).
 Corrosion resistance class CRC 2 to Festo standard FN 940070
 Moderate corrosion stress. Indoor applications in which condensation can occur. External visible parts with primarily decorative surface requirements that are in direct contact with a normal industrial environment.

Performance data – High vacuum																
Ejector characteristic	Standard H												Inline M			
Nominal width of Laval nozzle [mm]	0.45			0.7			0.95			1.4			2.0	3.0	0.45	0.7
Integrated function	A	M	B	A	M	B	A	M	B	A	M	B	M	M	A	A
Max. vacuum [%]	92			92			93			92			92	93	93	93
Operating pressure for max. vacuum [bar]	4.9			4.4			3.5			3.5			3.5	3.7	4.3	4.3
Max. suction rate with respect to atmosphere [l/min]	7.2			16.2			21.8			48.8			98	186	7.2	16.6
Operating pressure for max. suction rate [bar]	3			3			3			4			2	3	2	2
Pressurisation time at nominal operating pressure 6 bar (for 1 l volume) ¹⁾ [s]	3.63	3.9		1.5	1.69		0.96	1.06		0.43	0.5		0.24	0.13	4.1	1.69
Noise level at nominal operating pressure 6 bar [dB (A)]	56			65			71			69			63	78	66	75

- 1) Time required to reduce the vacuum to a residual vacuum of -0.05 bar after switching off the operating pressure.

Datasheet

Performance data – High suction rate															
Ejector characteristic		Standard L										Inline N			
Nominal width of Laval nozzle	[mm]	0.45			0.7			0.95			1.4			0.45	0.7
Integrated function		A	M	B	A	M	B	A	M	B	A	M	B	A	A
Max. suction rate with respect to atmosphere	[l/min]	13.6			30.9			40.5			92.6			13.3	32.6
Operating pressure for max. suction rate	[bar]	5			4			5			5			5	4
Pressurisation time at nominal operating pressure 6 bar (for 1 l volume) ¹⁾	[s]	1.93	1.97		0.79	0.83		0.62	0.67		0.28	0.32		2.24	0.89
Noise level at nominal operating pressure 6 bar	[dB (A)]	52			64			72			69			68	78

1) Time required to reduce the vacuum to a residual vacuum of –0.05 bar after switching off the operating pressure.

Technical data – On/off valve	
Operating voltage range	[V DC] 21.6 ... 26.4
Duty cycle	[%] 100
Degree of protection	IP40 (to EN 60529)
Valve function	2/2-way valve
Manual override	Non-detenting

Materials

Sectional view

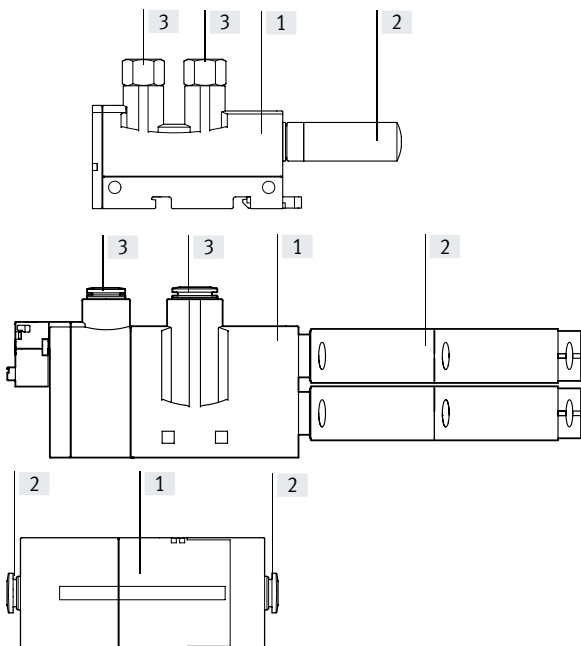

Vacuum generator VN – Standard	
[1] Housing	Reinforced PA, reinforced POM
[2] Silencer	RO1 PE
	RO2 Wrought aluminium alloy, POM, PU foam
[3] Push-in fitting	Nickel-plated brass
– Connecting thread	Anodised wrought aluminium alloy
– Jet nozzle	Wrought aluminium alloy
– Female nozzle	POM
– Screws	Steel
– Seals	NBR
Note on materials	RoHS-compliant
	RO2 Contains paint-wetting impairment substances

Vacuum generator VN – Inline	
[1] Housing	Reinforced PA, reinforced POM
[2] Push-in fitting	Nickel-plated brass
– Jet nozzle	Wrought aluminium alloy
– Female nozzle	POM
– Seals	NBR
Note on materials	RoHS-compliant

Datasheet

Vacuum p_u as a function of operating pressure p_1

High vacuum – Standard

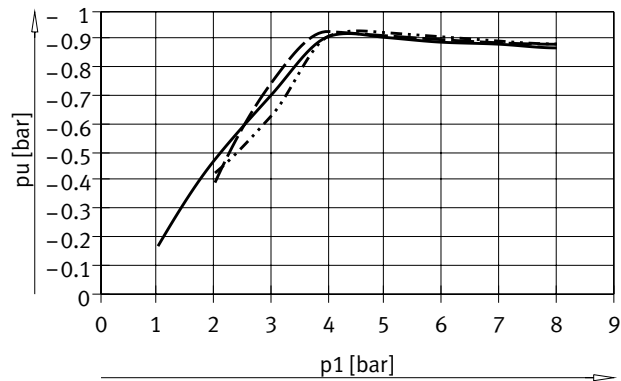

- VN-05-H
- VN-07-H
- - - VN-10-H

High suction rate – Standard

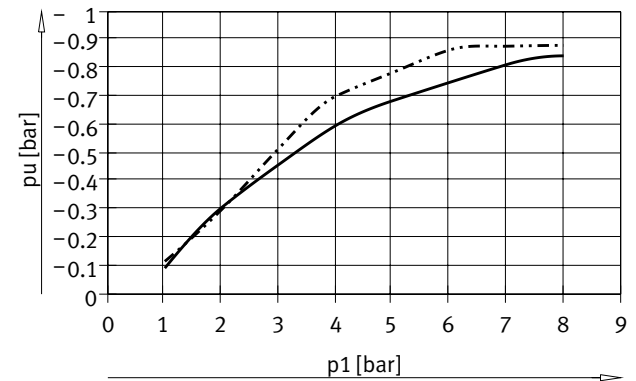

- VN-05-L
- VN-10-L

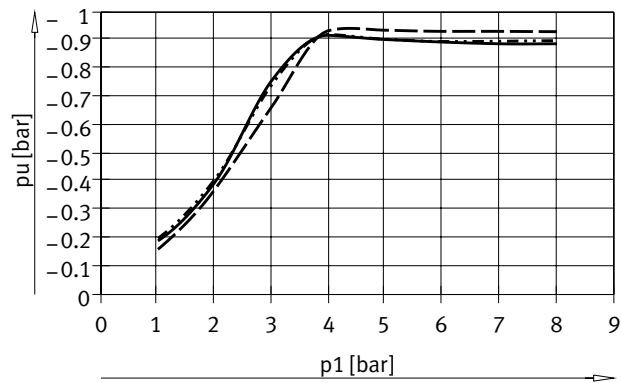

- VN-14-H
- VN-20-H
- - - VN-30-H

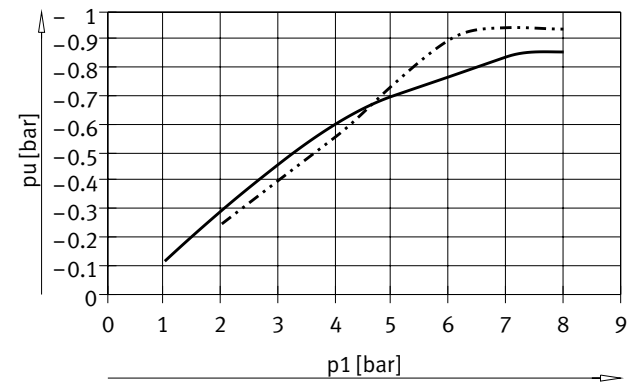

- VN-07-L
- VN-14-L

High vacuum – Inline

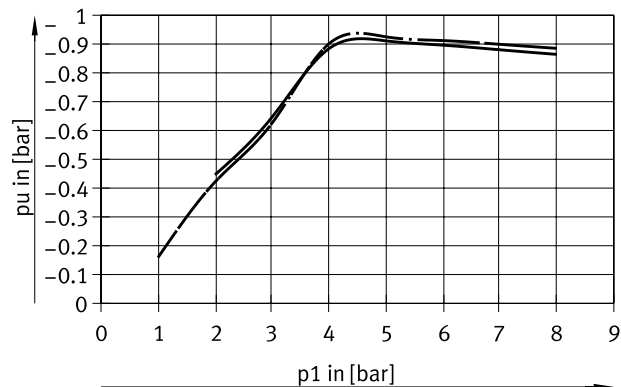

- VN-05-M
- VN-07-M

High suction rate – Inline

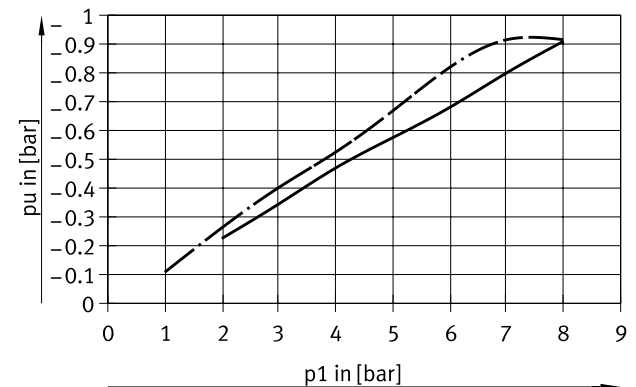

- VN-05-N
- VN-07-N

Datasheet

Evacuation time t as a function of vacuum p_u for 1 l volume at 6 bar operating pressure

High vacuum – Standard

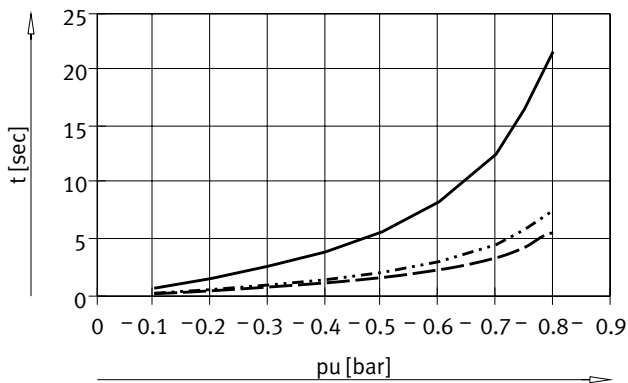

- VN-05-H
- VN-07-H
- - - VN-10-H

High suction rate – Standard

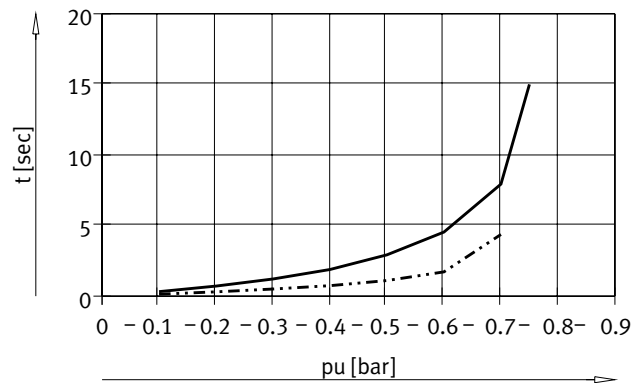

- VN-05-L
- VN-10-L

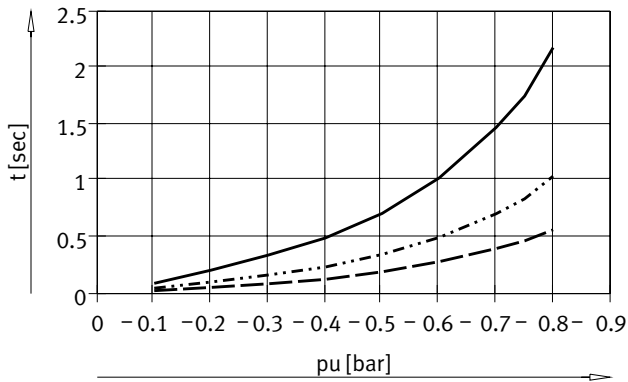

- VN-14-H
- VN-20-H
- - - VN-30-H

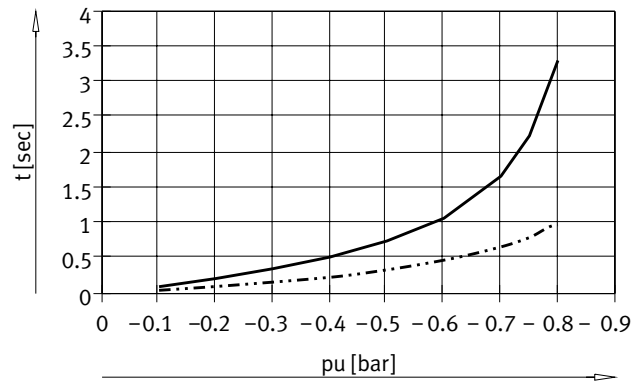

- VN-07-L
- VN-14-L

High vacuum – Inline

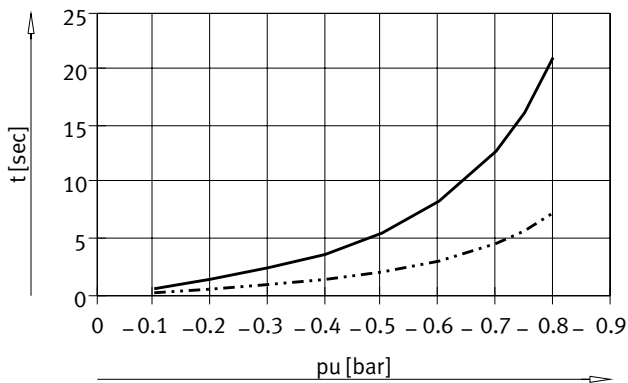

- VN-05-M
- VN-07-M

High suction rate – Inline

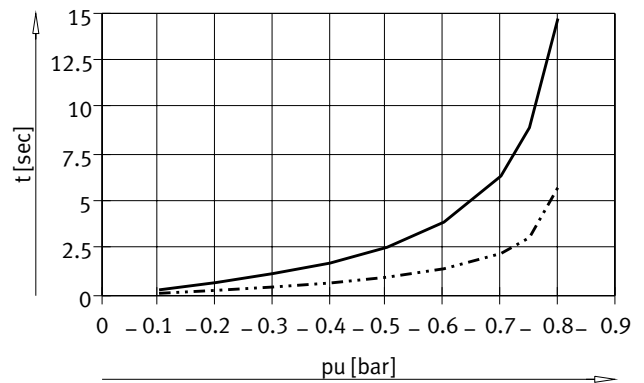

- VN-05-N
- VN-07-N

Datasheet

Suction rate q_{ns} (with respect to atmosphere) as a function of operating pressure p_1

High vacuum – Standard

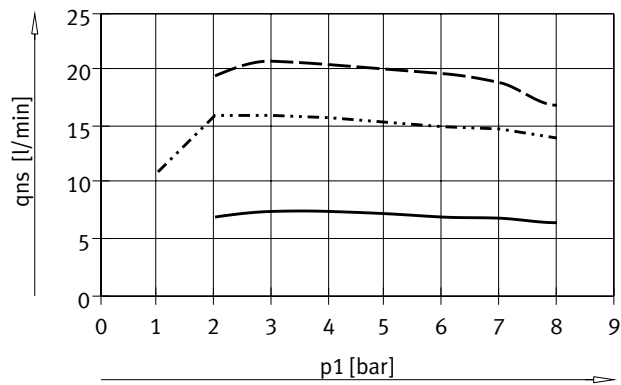

- VN-05-H
- VN-07-H
- - - VN-10-H

High suction rate – Standard

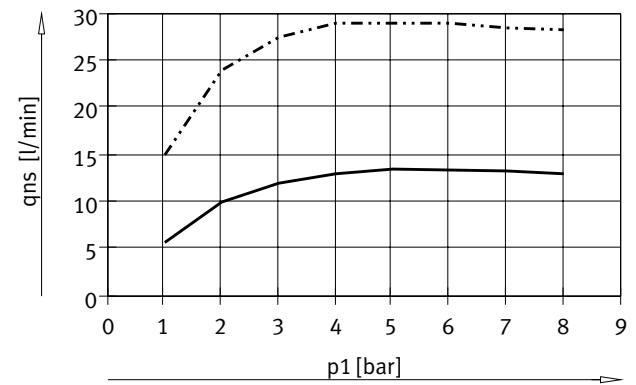

- VN-05-L
- VN-07-L

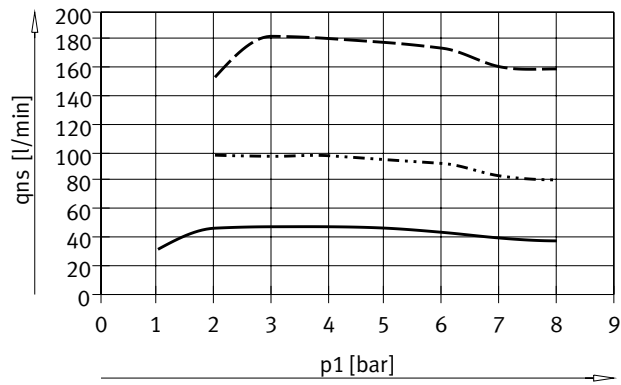

- VN-14-H
- VN-20-H
- - - VN-30-H

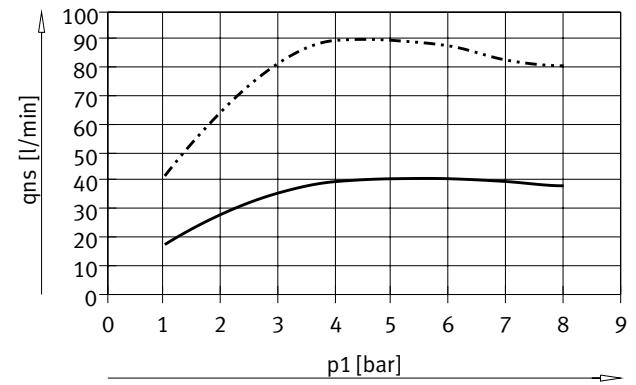

- VN-10-L
- VN-14-L

High vacuum – Inline

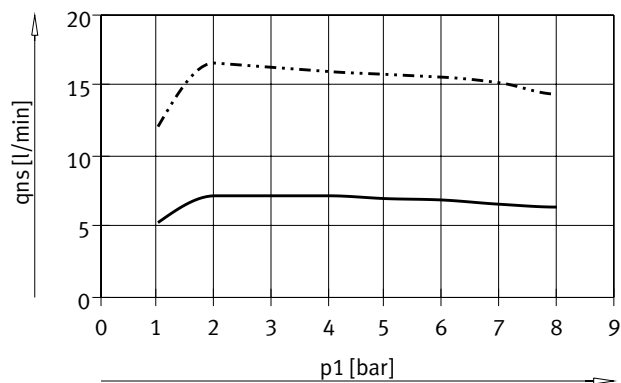

- VN-05-M
- VN-07-M

High suction rate – Inline

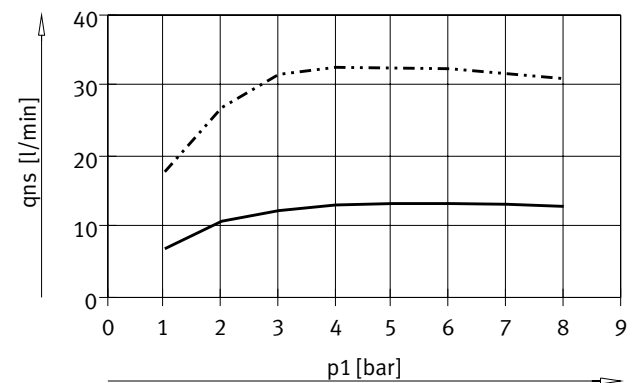

- VN-05-N
- VN-07-N

Datasheet

Air consumption q_n as a function of operating pressure p_1

High vacuum/high suction rate

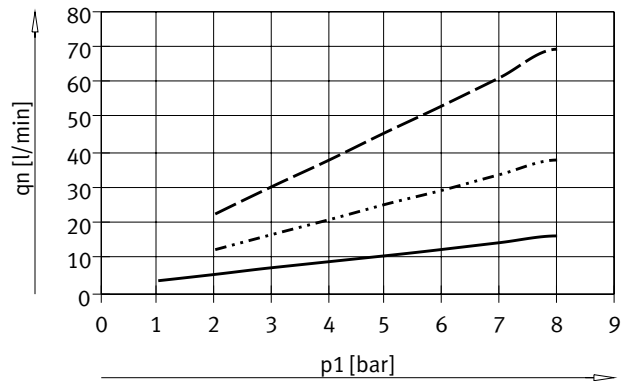

- VN-05
- VN-07
- - - - VN-10

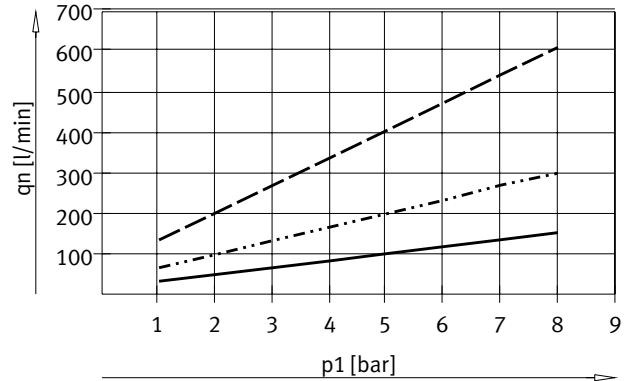

- VN-14
- VN-20
- - - - VN-30

Dimensions – T-shape/standard, VN-05/07/10/14

VN-...-T...-PQ...-VQ...-RO...-A

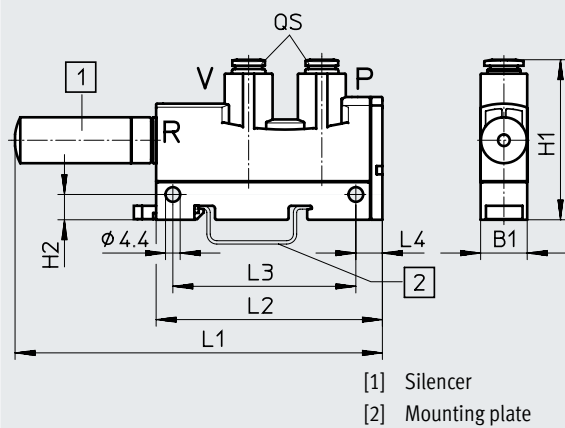

Download CAD data → www.festo.com

VN-...-T...-PI...-VI...-RO...-A

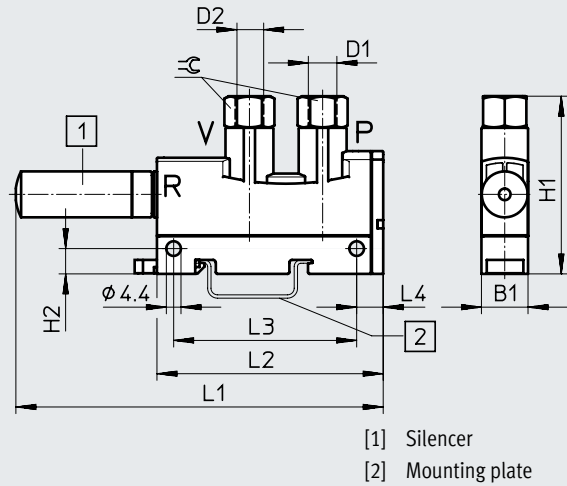

VN-...-T...-PQ...-VQ...-RO...-M/B

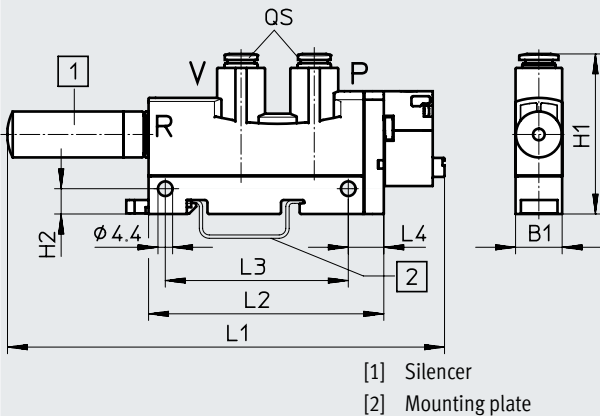

Datasheet

Type	B1	Connections		H1	H2	L1	L2	L3	L4	☞	
		P D1	V D2								
VN-05-...-T3-PQ2-VQ2-RO1-A	14	QS-6	QS-6	48	7.6	110	68	55	8	-	
VN-07-...-T3-PQ2-VQ2-RO1-A						119					
VN-10-...-T3-PQ2-VQ2-RO1-A						110					
VN-05-...-T3-PI4-VI4-RO1-A		G1/8	G1/8			53					119
VN-07-...-T3-PI4-VI4-RO1-A						119					
VN-10-...-T3-PI4-VI4-RO1-A											
VN-14-...-T4-PQ3-VQ3-RO2-A	18	QS-8	QS-8	50	7.5	166	98	63	8.7	-	
VN-14-...-T4-PI5-VI5-RO2-A		G1/4	G1/4	62						17	
VN-05-...-T3-PQ2-VQ2-RO1-M/B	14	QS-6	QS-6	48	7.6	132	71	55	10.7	-	
VN-07-...-T3-PQ2-VQ2-RO1-M/B						141					
VN-10-...-T3-PQ2-VQ2-RO1-M/B											
VN-14-...-T4-PQ3-VQ3-RO2-M/B	18	QS-8	QS-8	50	7.5	192	106	63	16.4	-	

Note: This product corresponds to ISO 1179-1 and ISO 228-1.

Dimensions – T-shape/standard, VN-20/30

Download CAD data → www.festo.com

VN-...-T6-PQ4-VQ5-RO2-M

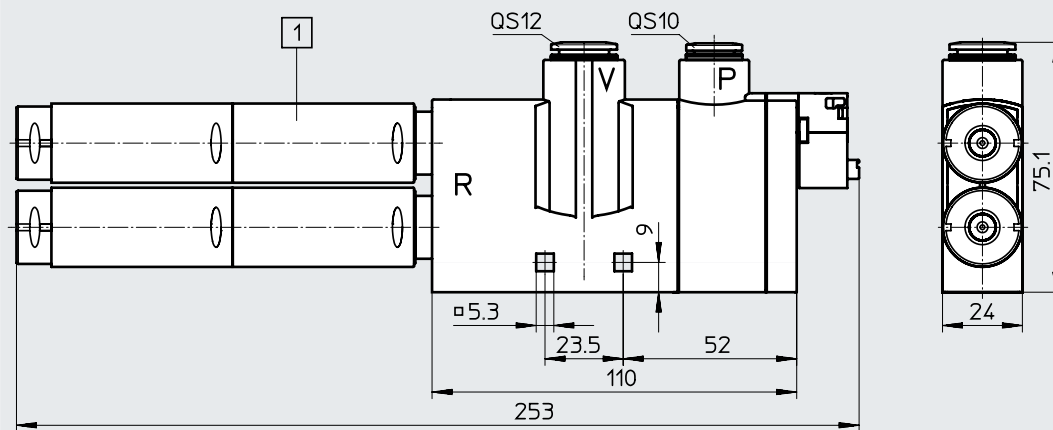

[1] Silencer

Dimensions – Straight shape/inline, VN-05/07

Download CAD data → www.festo.com

VN-05/07-...-I3-PQ2-VQ2-A

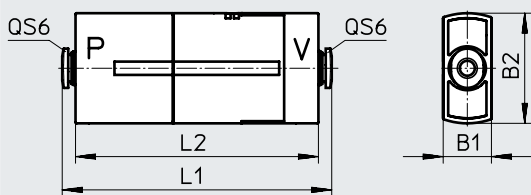

Type	B1	Connections		B2	L1	L2
		P	V			
VN-05-...-I3-PQ2-VQ2-A	14.5	QS-6	QS-6	33.1	81	73
VN-07-...-I3-PQ2-VQ2-A					97	89

Datasheet

★ Core Range

Ordering data and weights – Standard						
T-shape						
Nominal width of Laval nozzle [mm]	Weight [g]	High vacuum H		Weight [g]	High suction rate L	
		Part no.	Type		Part no.	Type
With electric on/off valve, pneumatic ejector pulse, push-in fitting and silencer						
0.95	–	–	–	63	★ 532641	VN-10-L-T3-PQ2-VQ2-R01-B
1.4	–	–	–	100	★ 532649	VN-14-L-T4-PQ3-VQ3-R02-B



Ordering data and weights – Standard						
T-shape						
Nominal width of Laval nozzle [mm]	Weight [g]	High vacuum H		Weight [g]	High suction rate L	
		Part no.	Type		Part no.	Type
With pneumatic ejector pulse, push-in fitting and silencer						
0.45	49	532620	VN-05-H-T3-PQ2-VQ2-R01-A	49	532621	VN-05-L-T3-PQ2-VQ2-R01-A
0.7	50	532628	VN-07-H-T3-PQ2-VQ2-R01-A	50	532629	VN-07-L-T3-PQ2-VQ2-R01-A
0.95	50	532638	VN-10-H-T3-PQ2-VQ2-R01-A	50	532639	VN-10-L-T3-PQ2-VQ2-R01-A
1.4	85	532646	VN-14-H-T4-PQ3-VQ3-R02-A	85	532647	VN-14-L-T4-PQ3-VQ3-R02-A
With pneumatic ejector pulse, female thread and silencer						
0.45	49	537225	VN-05-H-T3-PI4-VI4-R01-A	49	537226	VN-05-L-T3-PI4-VI4-R01-A
0.7	50	532632	VN-07-H-T3-PI4-VI4-R01-A	50	532633	VN-07-L-T3-PI4-VI4-R01-A
0.95	50	532642	VN-10-H-T3-PI4-VI4-R01-A	50	532643	VN-10-L-T3-PI4-VI4-R01-A
1.4	94	532719	VN-14-H-T4-PI5-VI5-R02-A	94	532720	VN-14-L-T4-PI5-VI5-R02-A
With electric on/off valve, push-in fitting and silencer						
0.45	60	532618	VN-05-H-T3-PQ2-VQ2-R01-M	60	532619	VN-05-L-T3-PQ2-VQ2-R01-M
0.7	61	532626	VN-07-H-T3-PQ2-VQ2-R01-M	61	532627	VN-07-L-T3-PQ2-VQ2-R01-M
0.95	61	532636	VN-10-H-T3-PQ2-VQ2-R01-M	61	532637	VN-10-L-T3-PQ2-VQ2-R01-M
1.4	98	532644	VN-14-H-T4-PQ3-VQ3-R02-M	98	532645	VN-14-L-T4-PQ3-VQ3-R02-M
2.0	215	532656	VN-20-H-T6-PQ4-VQ5-R02-M	–	–	–
3.0	215	532662	VN-30-H-T6-PQ4-VQ5-R02-M	–	–	–
With electric on/off valve, pneumatic ejector pulse, push-in fitting and silencer						
0.45	62	532622	VN-05-H-T3-PQ2-VQ2-R01-B	62	532623	VN-05-L-T3-PQ2-VQ2-R01-B
0.7	63	532630	VN-07-H-T3-PQ2-VQ2-R01-B	63	532631	VN-07-L-T3-PQ2-VQ2-R01-B
0.95	63	532640	VN-10-H-T3-PQ2-VQ2-R01-B	–	–	–
1.4	100	532648	VN-14-H-T4-PQ3-VQ3-R02-B	–	–	–

Ordering data and weights – Inline						
Straight shape						
Nominal width of Laval nozzle [mm]	Weight [g]	High vacuum M		Weight [g]	High suction rate N	
		Part no.	Type		Part no.	Type
With pneumatic ejector pulse and push-in connector						
0.45	38	532624	VN-05-M-I3-PQ2-VQ2-A	38	532625	VN-05-N-I3-PQ2-VQ2-A
0.7	41	532634	VN-07-M-I3-PQ2-VQ2-A	41	532635	VN-07-N-I3-PQ2-VQ2-A

Datasheet

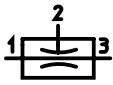
Function



-  - Temperature range
0 ... +60°C
-  - Operating pressure
1 ... 8 bar



General technical data

Type	VN-05	VN-07	VN-10	VN-14	VN-20
Nominal width of Laval nozzle [mm]	0.45	0.7	0.95	1.4	2.0
Ejector characteristic	High vacuum/standard H High suction rate/standard L				
Mounting position	Any				

Operating and environmental conditions

Operating pressure [bar]	1 ... 8
Nominal operating pressure [bar]	6
Operating medium	Compressed air to ISO 8573-1:2010 [7:4:4]
Note on the operating/pilot medium	Lubricated operation not possible
Ambient temperature [°C]	0 ... +60
Temperature of medium [°C]	0 ... +60
Corrosion resistance class CRC ¹⁾	2

1) Corrosion resistance class CRC 2 to Festo standard FN 940070

Moderate corrosion stress. Indoor applications in which condensation can occur. External visible parts with primarily decorative surface requirements that are in direct contact with a normal industrial environment.

Performance data – High vacuum

Ejector characteristic	Standard H				
Nominal width of Laval nozzle [mm]	0.45	0.7	0.95	1.4	2.0
Max. vacuum [%]	92	92	93	92	92
Operating pressure for max. vacuum [bar]	4.9	4.4	3.5	3.5	3.5
Max. suction rate with respect to atmosphere [l/min]	7.2	16.2	21.8	48.8	98
Operating pressure for max. suction rate [bar]	3	3	3	2	2
Pressurisation time at nominal operating pressure 6 bar (for 1 l volume) [s]	4.43	1.67	1.02	0.48	0.23

Datasheet

Performance data – High suction rate						
Ejector characteristic		Standard L				
Nominal width of Laval nozzle	[mm]	0.45	0.7	0.95	1.4	2.0
Max. suction rate with respect to atmosphere	[l/min]	13.6	30.9	41.5	92.6	184.4
Operating pressure for max. suction rate	[bar]	5	4	5	5	5
Pressurisation time at nominal operating pressure 6 bar (for 1 l volume)	[s]	2.04	0.82	0.66	0.31	0.17

 **Note**

Connecting two vacuum generator cartridges in parallel doubles the suction rate. This corresponds to the next higher power level.

Example:

2x20-H corresponds to 1x30-H

Materials

Sectional view

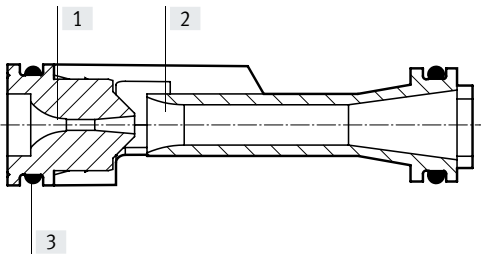

Vacuum generator cartridge VN-05/07/10/14/20

[1]	Jet nozzle	Wrought aluminium alloy
[2]	Female nozzle	POM
[3]	Seals	NBR

 **Note**

The graphs for the technical data of the vacuum generator cartridge match those for vacuum generator VN-A/B/M.

→ from page 36.

Datasheet

Dimensions

Download CAD data → www.festo.com

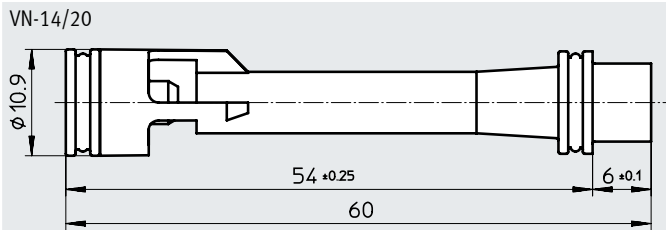
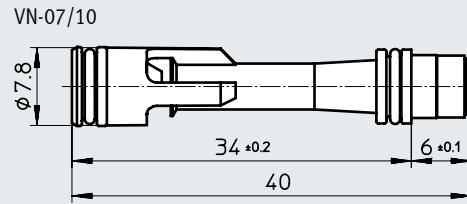
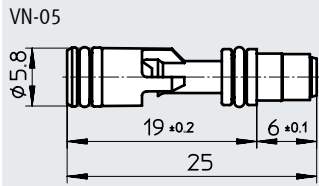

Locating hole for the vacuum generator cartridge

Dimensions

Installation of the vacuum generator cartridge

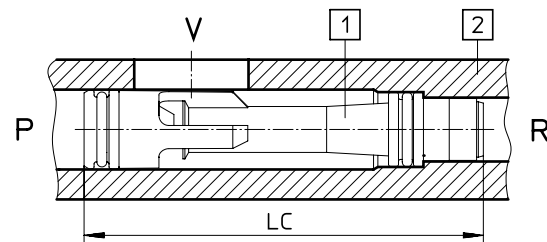
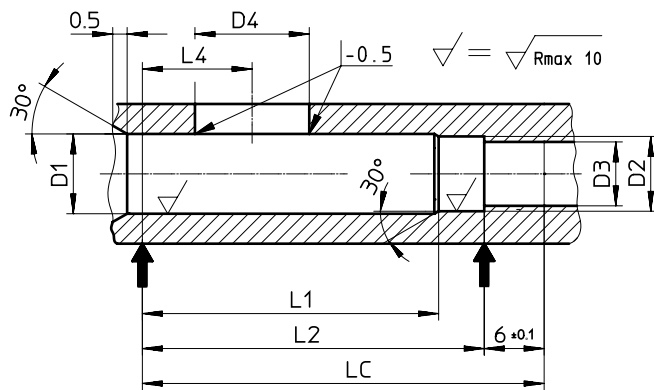

- [1] Vacuum generator cartridge
- [2] Customer-specific housing

Type	Dimensions of the locating hole						Vacuum connection		
	D1 ¹⁾ +0.05	D2	D3	L1	L2 ±0.2	LC ²⁾	L4 ±0.2	D4 min. Ø ³⁾ max. Ø	
VN-05	6	5.7 +0.05	4.9 +0.1	14	19	25	9.5	3.0	3.5
VN-07	8	7.5 +0.05	6.5 +0.1	29	34	40	11	6.0	7.5
VN-10									
VN-14	11.1	10.7 -0.05	9.4 ±0.1	49	54	60	13	12.8	15.6
VN-20									

- 1) For D1 with diameter of 11.1: for a threaded connection G1/4, choose the core diameter 11.8 +0.1
- 2) Length of the vacuum generator cartridge
- 3) Minimum cross section, Festo recommends the largest cross section possible

Ordering data and weight

Nominal width of Laval nozzle [mm]	Weight [g]	High vacuum H		Weight [g]	High suction rate L	
		Part no.	Type		Part no.	Type
0.45	0.65	547693	VN-05-H	0.65	547694	VN-05-L
0.7	1.65	547695	VN-07-H	1.65	547696	VN-07-L
0.95	1.65	547697	VN-10-H	1.65	547698	VN-10-L
1.4	3.75	547699	VN-14-H	3.75	547700	VN-14-L
2.0	3.75	547701	VN-20-H	3.75	547702	VN-20-L

Accessories

Mounting plate VN-...-BP-NRH

For vacuum generator VN
For mounting on H-rail or via through-hole

Ambient temperature: 0°... +60°C

Material:

Plate VN-T2/T3/T4: Reinforced POM

Plate VN-T6: Reinforced PA

Slide: POM

RoHS-compliant

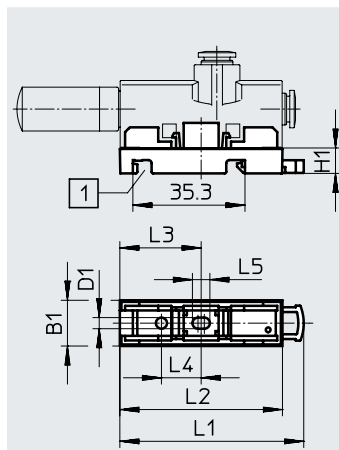

Note
Horizontal wall mounting is not permitted with mounting plate VN-T6-BP-NRH.

1) Suitable for H-rail 35x7.5 to DIN EN 50022

Dimensions and ordering data

For grid dimension [mm]	B1	D1	H1	L1	L2	L3	L4	L5	CRC ¹⁾	Weight [g]	Part no.	Type
10	10.4	3.5	8	56.5	51	25.5	12.5	5.5	2	3.5	196951	VN-T2-BP-NRH
14	14.4			57.9	51.2	25.6	12.5	5.5	2	4.5	193641	VN-T3-BP-NRH
18	18.4			59.9	53.2	25.6	12.5	5.5	2	5.5	195279	VN-T4-BP-NRH
24	24	4.3	7.3	98	91	45.5	32.5	6.3	2	12.4	196956	VN-T6-BP-NRH

1) Corrosion resistance class CRC 2 to Festo standard FN 940070

Moderate corrosion stress. Indoor applications in which condensation can occur. External visible parts with primarily decorative surface requirements that are in direct contact with a normal industrial environment.

Mounting plate VN-...-BP

For vacuum generator VN-A/B/M
For wall mounting via through-hole for housing type T3/T4

Material:

Plate: Galvanised steel

RoHS-compliant

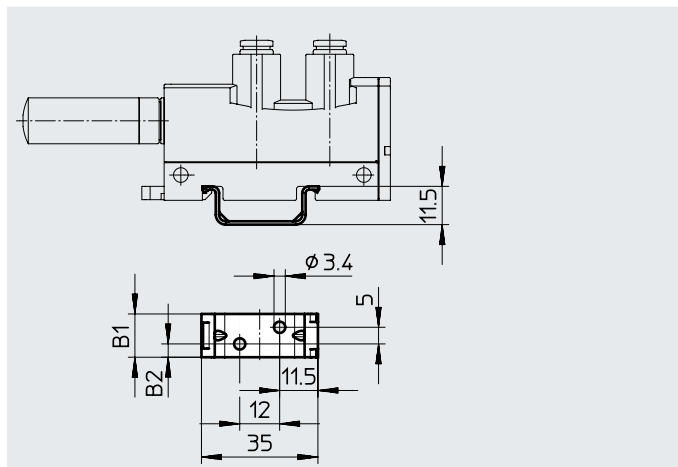

Note
Mounting plate VN-T6-BP-NRH should be used for housing type T6.

Dimensions and ordering data

For grid dimension [mm]	B1	B2	CRC ¹⁾	Weight [g]	Part no.	Type
14	13	4	2	4.8	547436	VN-T3-BP
18	17	6		6.4	547437	VN-T4-BP



1) Corrosion resistance class CRC 2 to Festo standard FN 940070

Moderate corrosion stress. Indoor applications in which condensation can occur. External visible parts with primarily decorative surface requirements that are in direct contact with a normal industrial environment.

Accessories

★ Core Range

Ordering data – Silencer UO				Datasheets → Internet: uo	
	For grid dimension [mm]	Pneumatic connection	Part no.	Type	
	10 (VN-...T2-...R01 only)	M7	197582	UO-M7	
	14	G1/8	197583	UO-1/8	
	18	G1/4	197584	UO-1/4	

Ordering data – Silencer AMTE					Datasheets → Internet: amte	
	For grid dimension [mm]	Pneumatic connection	Part no.	Type	PU ¹⁾	
Short version						
	10	M5	1206621	AMTE-M-H-M5	20	
	14	G1/8	1206622	AMTE-M-H-G18	20	
	18	G1/4	1206623	AMTE-M-H-G14	20	
Long version						
	10	M5	★ 1205858	AMTE-M-LH-M5	20	
	14	G1/8	★ 1205860	AMTE-M-LH-G18	20	
	18	G1/4	★ 1205861	AMTE-M-LH-G14	20	



1) Packaging unit

Ordering data – Silencer UOM				Datasheets → Internet: uom	
	For grid dimension [mm]	Pneumatic connection	Part no.	Type	
	18	G1/4	538432	UOM-1/4	
	24	G3/8	538433	UOM-3/8	

Ordering data – Silencer extension UOMS				Datasheets → Internet: uoms	
	For grid dimension [mm]	Pneumatic connection	Part no.	Type	
	18	–	538436	UOMS-1/4	
	24	–	538437	UOMS-3/8	

Accessories

★ Core Range

Ordering data – Connecting cable NEBU-M8					Datasheets → Internet: nebu
	Electrical connection	Number of wires	Cable length [m]	Part no.	Type
	M8x1, straight socket	3	2.5	★ 541333	NEBU-M8G3-K-2.5-LE3
			5	★ 541334	NEBU-M8G3-K-5-LE3
	M8x1, angled socket	3	2.5	★ 541338	NEBU-M8W3-K-2.5-LE3
			5	★ 541341	NEBU-M8W3-K-5-LE3

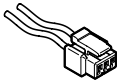
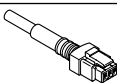
Ordering data – Plug socket with cable NEBV					Datasheets → Internet: nebu
	Cable composition	Product weight [g]	Cable length [m]	Part no.	Type
	2 individual cables	4	0.5	★ 566654	NEBV-H1G2-KN-0.5-N-LE2
		7	1	★ 566655	NEBV-H1G2-KN-1-N-LE2
		17	2.5	★ 566656	NEBV-H1G2-KN-2.5-N-LE2
		31	5	566657	NEBV-H1G2-KN-5-N-LE2
	Cable, 2-core	8	0.5	★ 566658	NEBV-H1G2-P-0.5-N-LE2
		16	1	★ 566659	NEBV-H1G2-P-1-N-LE2
		35	2.5	★ 566660	NEBV-H1G2-P-2.5-N-LE2
		70	5	566661	NEBV-H1G2-P-5-N-LE2