



# SERIES 1830 - SINGLE AND DOUBLE-POLE ROCKER SWITCHES

TO 20 (4) A 250 V AC



## PRODUCT FEATURES

- 100 million times proven switching principle
- mechanical life endurance up to 1 million switching cycles
- Large variety
- Variants with IP 67 or dust protection insert
- Two housing variants
- Actuating characteristic
- Illuminated and non-illuminated variants
- Approval for 400 V (product-dependent)

## ON REQUEST

- Other colors
- Other rocker printings
- Other lamp variants
- Snap-on customized actuators
- Cable assembly

Mechanical life endurance	10E4 5E4 (basic type 1839) 1E6 (product-dependent)
Inrush current (capacitive)	120 A / 50 A (contact pair Ag / Cu and basic type 1834)
Contact resistance (new condition)	< 100 mOhm (1 A 12 V DC)
Insulation resistance (new condition)	> 100 MOhm (500 V DC)
Proof tracking	250 PTI
Protection type	IP 40 / IP 67 (product-dependent)
Ambient temperature	terminal side -20 °C ... +105 °C / ... +85 °C / ... +100 °C (product-dependent) actuating side -20 °C ... +55 °C
Flammability	UL 94 V-2 UL 94 V-0 (product-dependent)
Glow wire test temperature	850 °C
Material actuator housing terminals	PA / PC (product-dependent) PA silver plated / tinned (product-dependent)
Plug force of the terminals	≤ 80 N
Approval marks	
Suitable for appliances of protection class II	



# SERIES 1830 - SINGLE AND DOUBLE-POLE ROCKER SWITCHES

TO 20 (4) A 250 V AC

 single-pole		ON / OFF switch (SPST)													
		1830.3112	1830.3118	1830.0102	1831.0114	1831.3312	1831.3313	1831.3606	1831.3607	1831.3815	1831.3816	1831.3933	1831.8112	1831.3311	1831.1107
Lighting voltage (V)		230	230	230											
Actuator color / printing															
Housing color															
20 (4) A 250 V AC 1E4		○	○		○	○	○	○	○	○	○	○	○		
20 (4) A 250 V AC														○	
16 (4) A 250 V AC 1E4															
10 (8) A 400 V AC 5E4															
10 (8) A 250 V AC 5E4		○	○		○	○	○	○	○	○	○	○	○	○	
10 (4) A 250 V AC 1E4				○											○
10 A 12 V DC															
6 (4) A 250 V AC 5E4				○											○
6 (4) A 250 V AC 1E4															
6 (4) A 250 V AC															
4 (2) A 250 V AC 1E4															
30 mA 12 V DC															
16 A 250 V AC 1 HP		○	○		○	○	○	○	○	○	○	○	○	○	
16 A 250 V AC 1/2 HP															
16 A 125 V AC 1/3 HP					○	○	○	○	○	○	○	○	○	○	
16 A 125 V AC 1/4 HP															
6 A 250 V AC 1/2 HP				○											○
6 A 125 V AC 1/4 HP															○
6 A 125 - 250 V AC 1/8 HP															
6 A 125 V AC 1/10 HP															
4 A 250 V AC 1/10 HP															
Terminal type															
Terminal description		6.3	6.3			6.3	6.3	6.3	6.3	6.3	6.3	6.3	6.3	6.3	4.8
Contact distance (mm)		≥ 3	≥ 3	≥ 3	≥ 3	≥ 3	≥ 3	≥ 3	≥ 3	≥ 3	≥ 3	≥ 3	≥ 3	≥ 3	≥ 3
Contact material		Ag	Ag	Ag	Ag	Ag	Ag	Ag	Ag	Ag	Ag	Ag	Ag	Ag	Ag
EN 60335 cap. 30 conform "G"								○	○					○	
Miscellaneous								housing with 2 separating gates	housing with 2 separating gates	1E6 mechanical life endurance IP 67	1E6 mechanical life endurance IP 67		lower lying flange		
Stock version		○	○			○	○						○	○	○

ROCKERSWITCHES  
PUSHBUTTON SWITCHES  
TOGGLE SWITCHES  
SLIDE SWITCHES  
ROTARY SWITCHES  
FOOT SWITCHES  
TACT AND KEY SWITCHES  
SNAP-ACTION SWITCHES  
MICRO-SIGNAL SWITCHES  
SENSORS  
ECO  
PUSH-N-DRAW



# SERIES 1830 - SINGLE AND DOUBLE-POLE ROCKER SWITCHES

TO 20 (4) A 250 V AC

<div style="text-align: center;">  <p>single-pole</p> </div>	Normally open switch (SPNO)				Changeover switch (SPDT)			Changeover switch with OFF position in the center (SPDT - Center OFF)					
	1831.1202	1831.3402	1831.8202	1831.1253	1833.3312	1833.1102	1833.3307	1838.0305	1838.3901	1838.1402	1838.1502	1838.1509	1838.1602
Lighting voltage (V)													
Actuator color / printing													
Housing color													
20 (4) A 250 V AC 1E4													
20 (4) A 250 V AC													
16 (4) A 250 V AC 1E4					<input type="checkbox"/>			<input type="checkbox"/>	<input type="checkbox"/>				
10 (8) A 400 V AC 5E4													
10 (8) A 250 V AC 5E4													
10 (4) A 250 V AC 1E4							<input type="checkbox"/>						
10 A 12 V DC													
6 (4) A 250 V AC 5E4							<input type="checkbox"/>						
6 (4) A 250 V AC 1E4										<input type="checkbox"/>		<input type="checkbox"/>	
6 (4) A 250 V AC											<input type="checkbox"/>	<input type="checkbox"/>	<input type="checkbox"/>
4 (2) A 250 V AC 1E4	<input type="checkbox"/>	<input type="checkbox"/>	<input type="checkbox"/>										
30 mA 12 V DC				<input type="checkbox"/>									
16 A 250 V AC 1 HP						<input type="checkbox"/>		<input type="checkbox"/>	<input type="checkbox"/>				
16 A 250 V AC 1/2 HP													
16 A 125 V AC 1/3 HP						<input type="checkbox"/>		<input type="checkbox"/>	<input type="checkbox"/>				
16 A 125 V AC 1/4 HP													
6 A 250 V AC 1/2 HP							<input type="checkbox"/>	<input type="checkbox"/>					
6 A 125 V AC 1/4 HP							<input type="checkbox"/>	<input type="checkbox"/>					
6 A 125 - 250 V AC 1/8 HP									<input type="checkbox"/>	<input type="checkbox"/>	<input type="checkbox"/>	<input type="checkbox"/>	<input type="checkbox"/>
6 A 125 V AC 1/10 HP	<input type="checkbox"/>	<input type="checkbox"/>	<input type="checkbox"/>										
4 A 250 V AC 1/10 HP	<input type="checkbox"/>	<input type="checkbox"/>	<input type="checkbox"/>										
Terminal type													
Terminal description	4.8	6.3	6.3	4.8	6.3	4.8	6.3		6.3	4.8	4.8	4.8	4.8
Contact distance (mm)	≥ 3	≥ 3	≥ 3	≥ 3	≥ 3	≥ 3	≥ 3	≥ 3	≥ 3	≥ 3	≥ 3	≥ 3	≥ 3
Contact material	Ag	Ag	Ag	Au	Ag	Ag	Ag	Ag	Ag	Ag	Ag	Ag	Ag
EN 60335 cap. 30 conform "G"							<input type="checkbox"/>						
Miscellaneous			lower lying flange						momentary function both sides	1E6 mechanical life endurance IP 67	momentary function both sides		momentary function one side
Stock version	<input type="checkbox"/>	<input type="checkbox"/>							<input type="checkbox"/>	<input type="checkbox"/>	<input type="checkbox"/>	<input type="checkbox"/>	<input type="checkbox"/>

ROCKERSWITCHES

PUSHBUTTON SWITCHES

TOGGLE SWITCHES

SLIDE SWITCHES

ROTARY SWITCHES

FOOT SWITCHES

TACT AND KEY SWITCHES

SWAP-ACTION SWITCHES

MIKRO-SIGNALSCHALTER

SENSORS

















ECO

PUSH'DRIVE



# SERIES 1830 - SINGLE AND DOUBLE-POLE ROCKER SWITCHES

TO 20 (4) A 250 V AC

single-pole		Changeover switch with OFF position in the center (SPDT - Center OFF)				Changeover switch (SPDT momentary)		
		1838.4307	1838.8302	1838.3402	1838.3502	1835.3902	1833.1202	1833.3402
Lighting voltage (V)						230		
Actuator color / printing	 							
Housing color								
20 (4) A 250 V AC 1E4								
20 (4) A 250 V AC								
16 (4) A 250 V AC 1E4								
10 (8) A 400 V AC 5E4								
10 (8) A 250 V AC 5E4								
10 (4) A 250 V AC 1E4								
10 A 12 V DC								
6 (4) A 250 V AC 5E4								
6 (4) A 250 V AC 1E4		○	○					
6 (4) A 250 V AC				○	○			
4 (2) A 250 V AC 1E4						○	○	○
30 mA 12 V DC								
16 A 250 V AC 1 HP								
16 A 250 V AC 1/2 HP								
16 A 125 V AC 1/3 HP								
16 A 125 V AC 1/4 HP								
6 A 250 V AC 1/2 HP								
6 A 125 V AC 1/4 HP								
6 A 125 - 250 V AC 1/8 HP		○	○	○	○			
6 A 125 V AC 1/10 HP						○	○	○
4 A 250 V AC 1/10 HP						○	○	○
Terminal type								
Terminal description		2.8	6.3	6.3	6.3	6.3	4.8	6.3
Contact distance (mm)		≥ 3	≥ 3	≥ 3	≥ 3	≥ 3	≥ 3	≥ 3
Contact material		Ag	Ag	Ag	Ag	Ag	Ag	Ag
EN 60335 cap. 30 conform "G"								
Miscellaneous		momentary function one side	momentary function both sides lower lying flange	momentary function both sides		external lamp connection two-pole size		
Stock version				○	○			

ROCKER SWITCHES  
 PUSHBUTTON SWITCHES  
 TOGGLE SWITCHES  
 SLIDE SWITCHES  
 ROTARY SWITCHES  
 FOOT SWITCHES  
 TACT AND KEY SWITCHES  
 SMP-ACTION SWITCHES  
 MICRO-SIGNAL SWITCHES  
 SENSORS  
 ECO  
 PUSH IN DRIVE



# SERIES 1830 - SINGLE AND DOUBLE-POLE ROCKER SWITCHES

TO 20 (4) A 250 V AC

 <p>double-pole</p>		ON / OFF switch (DPST)														
		1835.3419	1835.3111	1835.3112	1835.3114	1835.3118	1835.9413	1835.3102	1835.3105	1835.3108	1835.3116	1835.3107	1832.1612	1832.3311	1832.3312	1832.3313
Lighting voltage (V)		400	230	230	230	230	230	230	230	230	115 - 230	12				
Actuator color / printing																
Housing color																
20 (4) A 250 V AC 1E4		<input type="radio"/>	<input type="radio"/>	<input type="radio"/>	<input type="radio"/>	<input type="radio"/>	<input type="radio"/>				<input type="radio"/>		<input type="radio"/>	<input type="radio"/>	<input type="radio"/>	<input type="radio"/>
20 (4) A 250 V AC																
16 (4) A 250 V AC 1E4																
10 (8) A 400 V AC 5E4		<input type="radio"/>														
10 (8) A 250 V AC 5E4		<input type="radio"/>	<input type="radio"/>	<input type="radio"/>	<input type="radio"/>	<input type="radio"/>	<input type="radio"/>				<input type="radio"/>		<input type="radio"/>	<input type="radio"/>	<input type="radio"/>	<input type="radio"/>
10 (4) A 250 V AC 1E4								<input type="radio"/>	<input type="radio"/>	<input type="radio"/>						
10 A 12 V DC												<input type="radio"/>				
6 (4) A 250 V AC 5E4								<input type="radio"/>	<input type="radio"/>	<input type="radio"/>						
6 (4) A 250 V AC 1E4																
6 (4) A 250 V AC																
4 (2) A 250 V AC 1E4																
30 mA 12 V DC																
16 A 250 V AC 1 HP		<input type="radio"/>	<input type="radio"/>	<input type="radio"/>	<input type="radio"/>	<input type="radio"/>	<input type="radio"/>				<input type="radio"/>		<input type="radio"/>	<input type="radio"/>	<input type="radio"/>	<input type="radio"/>
16 A 250 V AC 1/2 HP																
16 A 125 V AC 1/3 HP													<input type="radio"/>	<input type="radio"/>	<input type="radio"/>	<input type="radio"/>
16 A 125 V AC 1/4 HP																
6 A 250 V AC 1/2 HP								<input type="radio"/>	<input type="radio"/>	<input type="radio"/>						
6 A 125 V AC 1/4 HP																
6 A 125 - 250 V AC 1/8 HP																
6 A 125 V AC 1/10 HP																
4 A 250 V AC 1/10 HP																
Terminal type																
Terminal description		6.3	6.3	6.3	6.3	6.3		6.3	6.3	6.3	6.3	6.3	4.8	6.3	6.3	6.3
Contact distance (mm)		≥ 3	≥ 3	≥ 3	≥ 3	≥ 3	≥ 3	≥ 3	≥ 3	≥ 3	≥ 3	≥ 3	≥ 3	≥ 3	≥ 3	≥ 3
Contact material		Ag	Ag	Ag	Ag	Ag	Ag	Ag	Ag	Ag	Ag	Ag	Ag	Ag	Ag	Ag
EN 60335 cap. 30 conform "G"																<input type="radio"/>
Miscellaneous		cover frame 33.2 long					PCB holder 248.103.011 mounted lower lying flange						cover frame 33.2 long			
Stock version				<input type="radio"/>	<input type="radio"/>	<input type="radio"/>		<input type="radio"/>	<input type="radio"/>	<input type="radio"/>				<input type="radio"/>	<input type="radio"/>	<input type="radio"/>



# SERIES 1830 - SINGLE AND DOUBLE-POLE ROCKER SWITCHES

TO 20 (4) A 250 V AC

 double-pole		ON / OFF switch (DPST)								Normally open contact (DPNO)		Changeover switch (DPDT)																			
Lighting voltage (V)	Actuator color / printing	Housing color	20 (4) A 250 V AC 1E4	20 (4) A 250 V AC	16 (4) A 250 V AC 1E4	10 (8) A 400 V AC 5E4	10 (8) A 250 V AC 5E4	10 (4) A 250 V AC 1E4	10 A 12 V DC	6 (4) A 250 V AC 5E4	6 (4) A 250 V AC 1E4	6 (4) A 250 V AC	4 (2) A 250 V AC 1E4	30 mA 12 V DC	16 A 250 V AC 1 HP	16 A 250 V AC 1/2 HP	16 A 125 V AC 1/3 HP	16 A 125 V AC 1/4 HP	6 A 250 V AC 1/2 HP	6 A 125 V AC 1/4 HP	6 A 125 - 250 V AC 1/8 HP	6 A 125 V AC 1/10 HP	4 A 250 V AC 1/10 HP	Terminal type	Terminal description	Contact distance (mm)	Contact material	EN 60335 cap. 30 conform "G"	Miscellaneous	Stock version	
			○	○	○	○	○	○							○		○	○							⏏	6.3	≥ 3	Ag		cover frame 33.2 long	
			○	○			○	○									○	○							⏏	4.8	≥ 3	Ag		lower lying flange	
																									⏏		≥ 3	Ag		lower lying flange	
			○				○																		⏏	6.3	≥ 3	Ag		lower lying flange	
			○	○			○	○																	⏏		≥ 3	Ag		lower lying flange	
																									⏏	4.8	≥ 3	Ag		dust protection inlay	
																									⏏	6.3	≥ 3	Ag			
																									⏏	6.3	≥ 3	Ag		lower lying flange	
													○												⏏	6.3	≥ 3	Ag			
																									⏏	6.3	≥ 3	Ag			
																									⏏	6.3	≥ 3	Ag			
																									⏏	6.3	≥ 3	Ag			

ROCKER SWITCHES  
 PUSHBUTTON SWITCHES  
 TOGGLE SWITCHES  
 SLIDE SWITCHES  
 ROTARY SWITCHES  
 FOOT SWITCHES  
 TACT AND KEY SWITCHES  
 SNAP-ACTION SWITCHES  
 MICRO-SIGNAL SWITCHES  
 SENSORS  
 ECO  
 PUSH-N-DRAW



# SERIES 1830 - SINGLE AND DOUBLE-POLE ROCKER SWITCHES

TO 20 (4) A 250 V AC

ROCKERSWITCHES

PUSHBUTTON SWITCHES

TOGGLE SWITCHES

SLIDE SWITCHES

ROTARY SWITCHES

FOOT SWITCHES

TACT AND KEY SWITCHES

SNAP-ACTION SWITCHES

MIKRO-SIGNALSCHALTER

SENSORS

ECO

PUSH'DRIVE

 double-pole		Changeover switch (DPDT)					Changeover switch with OFF position in the center (DPDT - Center Off)									
Lighting voltage (V)		1834.1102	1834.3302	1834.3309	1834.3603	1834.6103	1839.3512	1839.1402	1839.1407	1839.1410	1839.1502	1839.1507	1839.1509	1839.1518	1839.1602	
Actuator color / printing																
Housing color																
20 (4) A 250 V AC 1E4																
20 (4) A 250 V AC																
16 (4) A 250 V AC 1E4							○									
10 (8) A 400 V AC 5E4																
10 (8) A 250 V AC 5E4																
10 (4) A 250 V AC 1E4		○	○	○	○	○										
10 A 12 V DC																
6 (4) A 250 V AC 5E4		○	○	○	○	○										
6 (4) A 250 V AC 1E4								○	○	○	○	○	○	○	○	
6 (4) A 250 V AC																
4 (2) A 250 V AC 1E4																
30 mA 12 V DC																
16 A 250 V AC 1 HP								○								
16 A 250 V AC 1/2 HP								○								
16 A 125 V AC 1/3 HP																
16 A 125 V AC 1/4 HP																
6 A 250 V AC 1/2 HP		○	○	○	○	○										
6 A 125 V AC 1/4 HP		○	○	○	○	○										
6 A 125 - 250 V AC 1/8 HP								○	○	○	○	○	○	○	○	
6 A 125 V AC 1/10 HP																
4 A 250 V AC 1/10 HP																
Terminal type																
Terminal description		4.8	6.3	6.3	6.3	4.8	6.3	4.8	4.8	4.8	4.8	4.8	4.8	4.8	4.8	
Contact distance (mm)		≥ 3	≥ 3	≥ 3	≥ 3	≥ 3	≥ 3	≥ 3	≥ 3	≥ 3	≥ 3	≥ 3	≥ 3	≥ 3	≥ 3	
Contact material		Ag	Ag	Ag	Ag	Ag	Ag	Ag	Ag	Ag	Ag	Ag	Ag	Ag	Ag	
EN 60335 cap. 30 conform "G"					○											
Miscellaneous					cover frame 33.2 long	lower lying flange		momentary function both sides	momentary function both sides	dust protection inlay momentary function both sides			dust protection inlay	momentary function one side		
Stock version			○	○				○	○			○				



# SERIES 1830 - SINGLE AND DOUBLE-POLE ROCKER SWITCHES

TO 20 (4) A 250 V AC

 double-pole		Changeover switch with OFF position in the center (DPDT - Center OFF)							Changeover switch (DPDT momentary)	
Lighting voltage (V)	Actuator color / printing	1839.3402	1839.3502	1839.3503	1839.3602	1839.7304	1839.3352	1839.0105	1834.3402	
Housing color		Black	Black	Grey	Black	Black with I O R	Black	Black with I O II	Black	
20 (4) A 250 V AC 1E4										
20 (4) A 250 V AC										
16 (4) A 250 V AC 1E4										
10 (8) A 400 V AC 5E4										
10 (8) A 250 V AC 5E4										
10 (4) A 250 V AC 1E4										
10 A 12 V DC										
6 (4) A 250 V AC 5E4										
6 (4) A 250 V AC 1E4		○	○	○	○	○				
6 (4) A 250 V AC										
4 (2) A 250 V AC 1E4									○	
30 mA 12 V DC							○			
16 A 250 V AC 1 HP										
16 A 250 V AC 1/2 HP										
16 A 125 V AC 1/3 HP										
16 A 125 V AC 1/4 HP										
6 A 250 V AC 1/2 HP										
6 A 125 V AC 1/4 HP										
6 A 125 - 250 V AC 1/8 HP		○	○	○	○	○				
6 A 125 V AC 1/10 HP									○	
4 A 250 V AC 1/10 HP									○	
Terminal type										
Terminal description		6.3	6.3	6.3	6.3	6.3	6.3	6.3	6.3	
Contact distance (mm)		≥ 3	≥ 3	≥ 3	≥ 3	≥ 3	≥ 3	≥ 3	≥ 3	
Contact material		Ag	Ag	Ag	Ag	Ag	Au	Ag	Ag	
EN 60335 cap. 30 conform "G"										
Miscellaneous		momentary function both sides			momentary function one side	dust protection inlay momentary function one side lower lying flange	cover frame 33.2 long momentary function both sides	dust protection inlay		
Stock version		○	○						○	

















ROCKER SWITCHES  
 PUSHBUTTON SWITCHES  
 TOGGLE SWITCHES  
 SLIDE SWITCHES  
 ROTARY SWITCHES  
 FOOT SWITCHES  
 TACT AND KEY SWITCHES  
 SNAP-ACTION SWITCHES  
 MICRO-SIGNAL SWITCHES  
 SENSORS  
 ECO  
 PUSH-N-DRAW





# SERIES 1830 - SINGLE AND DOUBLE-POLE ROCKER SWITCHES

TO 20 (4) A 250 V AC

	Lamp			
	1837.1118	1837.3102	1837.8102	1837.8108
<b>Lamp</b>				
<b>Lighting voltage (V)</b>	230	230	230	230
<b>Actuator color / printing</b>				
<b>Housing color</b>				
<b>20 (4) A 250 V AC 1E4</b>				
<b>20 (4) A 250 V AC</b>				
<b>16 (4) A 250 V AC 1E4</b>				
<b>10 (8) A 400 V AC 5E4</b>				
<b>10 (8) A 250 V AC 5E4</b>				
<b>10 (4) A 250 V AC 1E4</b>				
<b>10 A 12 V DC</b>				
<b>6 (4) A 250 V AC 5E4</b>				
<b>6 (4) A 250 V AC 1E4</b>				
<b>6 (4) A 250 V AC</b>				
<b>4 (2) A 250 V AC 1E4</b>				
<b>30 mA 12 V DC</b>				
<b>16 A 250 V AC 1 HP</b>				
<b>16 A 250 V AC 1/2 HP</b>				
<b>16 A 125 V AC 1/3 HP</b>				
<b>16 A 125 V AC 1/4 HP</b>				
<b>6 A 250 V AC 1/2 HP</b>				
<b>6 A 125 V AC 1/4 HP</b>				
<b>6 A 125 - 250 V AC 1/8 HP</b>				
<b>6 A 125 V AC 1/10 HP</b>				
<b>4 A 250 V AC 1/10 HP</b>				
<b>Terminal type</b>				
<b>Terminal description</b>	4.8	6.3	6.3	6.3
<b>Contact distance (mm)</b>				
<b>Contact material</b>				
<b>EN 60335 cap. 30 conform "G"</b>				
<b>Miscellaneous</b>			size basic type 1835	size basic type 1835
<b>Stock version</b>				

ROCKERSWITCHES

PUSHBUTTON SWITCHES

TOGGLE SWITCHES

SLIDE SWITCHES

ROTARY SWITCHES

FOOT SWITCHES

TACT AND KEY SWITCHES

SNAP-ACTION SWITCHES

MIKRO-SIGNALSCHALTER

SENSORS

ECO

PUSH'DRIVE



# SERIES 1830 - SINGLE AND DOUBLE-POLE ROCKER SWITCHES

TO 20 (4) A 250 V AC



Basic types 1830, 1831,  
1833 and 1838  
single-pole  
illuminated / non-illuminated

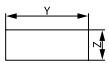

X = Wall thickness

x	y	z
0.75 ... 1.25	30 <sup>-0.1</sup>	11 <sup>+0.1</sup>
1.25 ... 2	30.2 <sup>-0.1</sup>	11 <sup>+0.1</sup>
2 ... 3	30.6 <sup>-0.1</sup>	11 <sup>+0.1</sup>

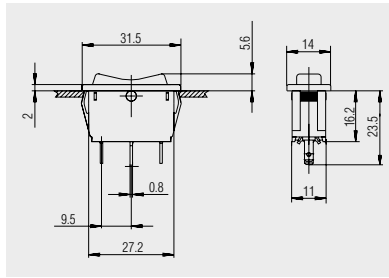

Quick-connect terminal 2.8 x 0.8  
1838.4307

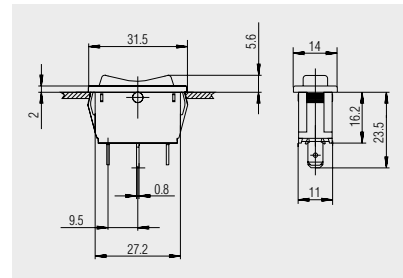

Quick-connect terminal 4.8 x 0.8  
basic type 1838

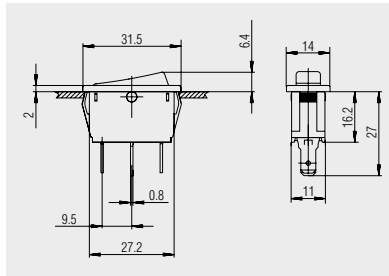

Quick-connect terminal 4.8 x 0.8  
basic types 1830, 1831 and  
1833

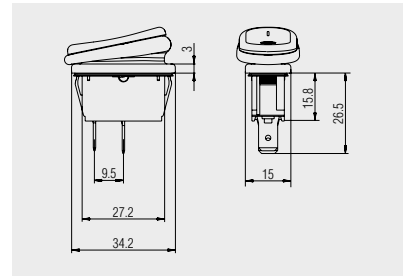

Quick-connect terminal 6.3 x 0.8  
1831.3815

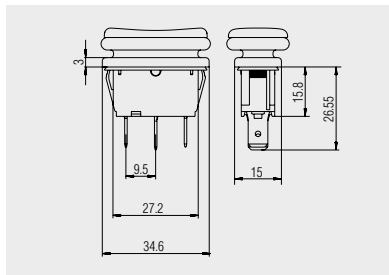

Quick-connect terminal 6.3 x 0.8  
1838.3901

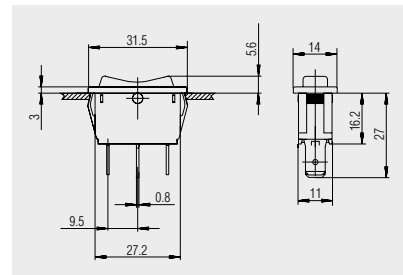

Quick-connect terminal 6.3 x 0.8  
basic type 1838

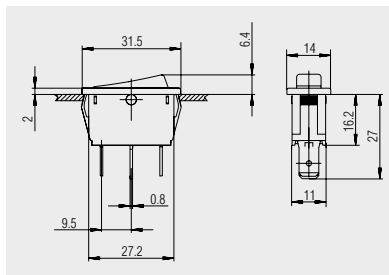

Quick-connect terminal 6.3 x 0.8  
basic types 1831 and 1833

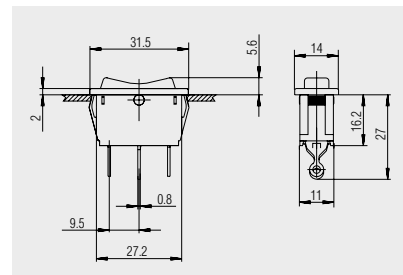

Solder terminal  
basic type 1838

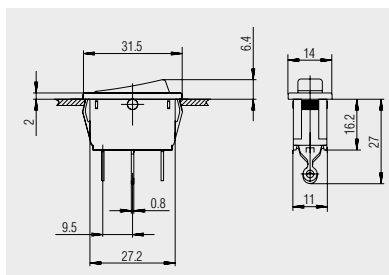

Solder terminal  
basic types 1830 and 1831

ROCKER SWITCHES  
PUSHBUTTON SWITCHES  
TOGGLE SWITCHES  
SLIDE SWITCHES  
ROTARY SWITCHES  
FOOT SWITCHES  
TACT AND KEY SWITCHES  
SNAP-ACTION SWITCHES  
MICRO-SIGNAL SWITCHES  
SENSORS  
ECO  
PUSH-IN DRIVE



# SERIES 1830 - SINGLE AND DOUBLE-POLE ROCKER SWITCHES

TO 20 (4) A 250 V AC



Basic types 1832, 1834, 1835 and 1839  
double-pole  
illuminated / non-illuminated

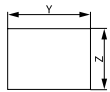

X = Wall thickness

x	y	z
0.75 ... 1.25	30 <sup>-0.1</sup>	22 <sup>+0.2</sup>
1.25 ... 2	30.2 <sup>-0.1</sup>	22 <sup>+0.2</sup>
2 ... 3	30.6 <sup>-0.1</sup>	22 <sup>+0.2</sup>

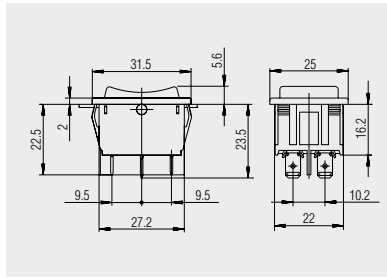

Quick-connect terminal 4.8 x 0.8

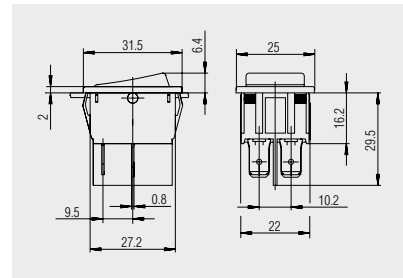

Quick-connect terminal 6.3 x 0.8 / 4.8  
basic types 1832, 1834 and 1835

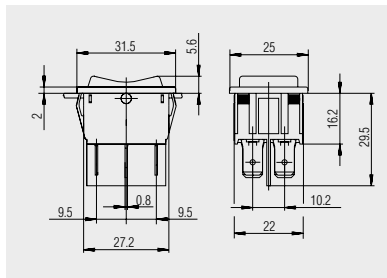

Quick-connect terminal 6.3 x 0.8  
basic type 1839

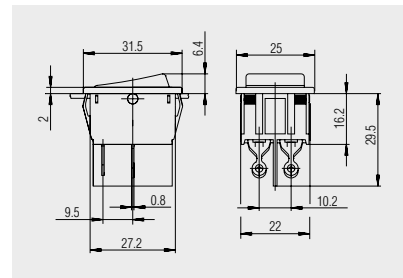

Solder terminal  
basic type 1832

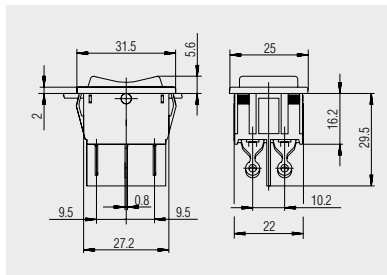

Solder terminal  
basic type 1839

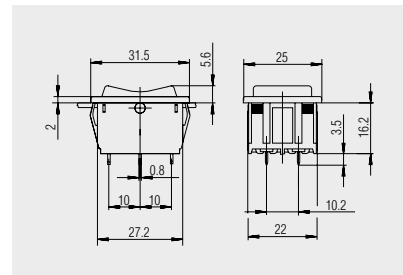

PCB terminal  
basic type 1839



Basic types 1830, 1831 and 1833  
single-pole, lower lying flange  
illuminated / non-illuminated



X = Wall thickness

x	y	z
0.75 ... 1.25	30 <sup>-0.1</sup>	11 <sup>+0.1</sup>
1.25 ... 2	30.2 <sup>-0.1</sup>	11 <sup>+0.1</sup>
2 ... 3	30.6 <sup>-0.1</sup>	11 <sup>+0.1</sup>

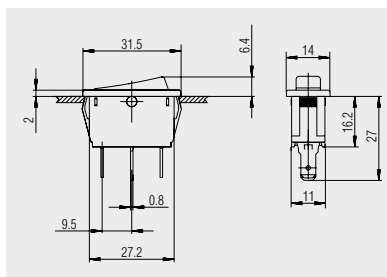

Quick-connect terminal 4.8 x 0.8  
basic types 1830, 1831 and 1833



# SERIES 1830 - SINGLE AND DOUBLE-POLE ROCKER SWITCHES

TO 20 (4) A 250 V AC



Basic types 1832, 1834,  
1835 and 1839  
double-pole, lower lying flange  
illuminated / non-illuminated

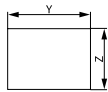

X = Wall thickness

x	y	z
0.75 ... 1.25	30 <sup>-0.1</sup>	22 <sup>+0.2</sup>
1.25 ... 2	30.2 <sup>-0.1</sup>	22 <sup>+0.2</sup>
2 ... 3	30.6 <sup>-0.1</sup>	22 <sup>+0.2</sup>

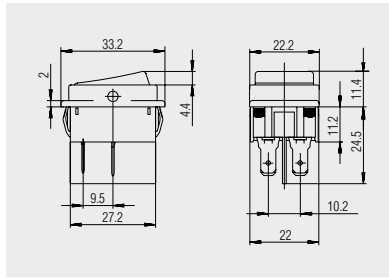

Quick-connect terminal 4.8 x 0.8  
basic types 1832 and 1834

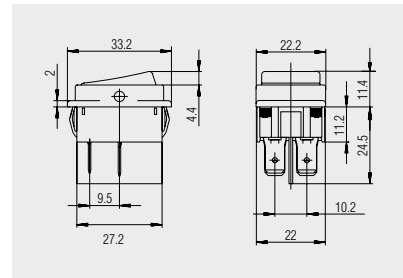

Quick-connect terminal 6.3 x 0.8  
basic type 1832

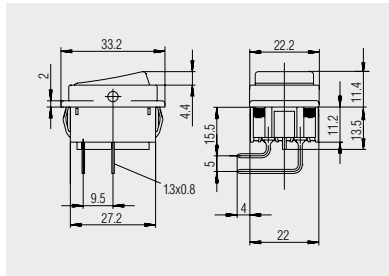

PCB terminal  
angled  
basic types 1832 and 1835

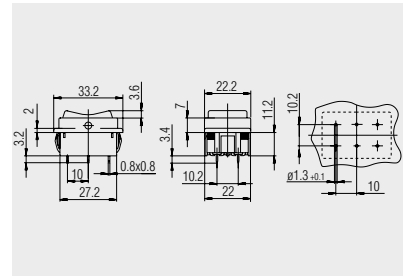

PCB terminal  
basic type 1839

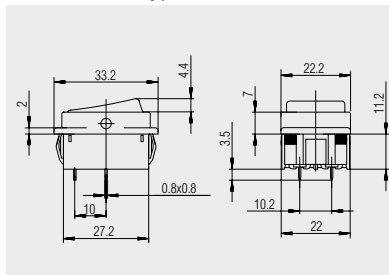

PCB terminal  
basic types 1832 and 1835

ROCKER SWITCHES

PUSHBUTTON SWITCHES

TOGGLE SWITCHES

SLIDE SWITCHES

ROTARY SWITCHES

FOOT SWITCHES

TACT AND KEY SWITCHES

SNAP-ACTION SWITCHES

MICRO-SIGNAL SWITCHES

SENSORS

ECO

PUSH 'N' DRIVE



# SERIES 1830 - SINGLE AND DOUBLE-POLE ROCKER SWITCHES

TO 20 (4) A 250 V AC



Basic type 1837 lamp  
single and double-pole

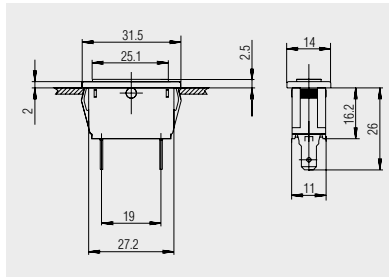

Quick-connect terminal 4.8 x 0.8  
single-pole size

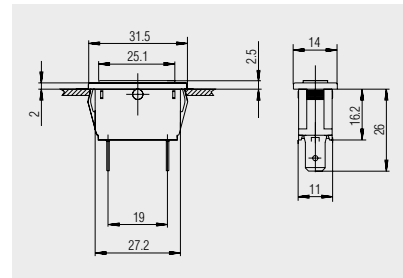

Quick-connect terminal 6.3 x 0.8  
single-pole size

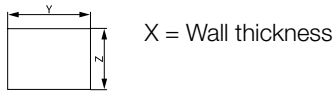

x	y	z
0.75 ... 1.25	30 <sup>-0.1</sup>	22 <sup>+0.1</sup>
1.25 ... 2	30.2 <sup>-0.1</sup>	22 <sup>+0.1</sup>
2 ... 3	30.6 <sup>-0.1</sup>	22 <sup>+0.1</sup>

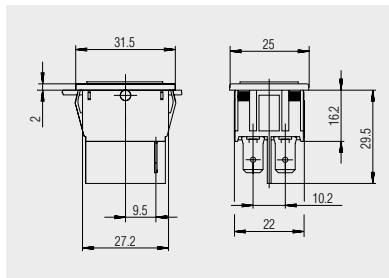

Quick-connect terminal 6.3 x 0.8  
double-pole size

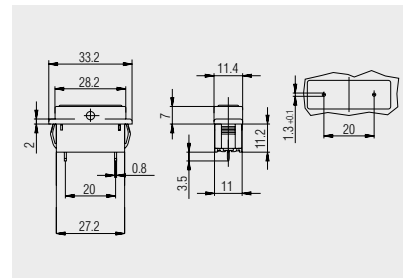

PCB terminal  
lower lying flange  
1837.2504



Protection cap  
203.731.011

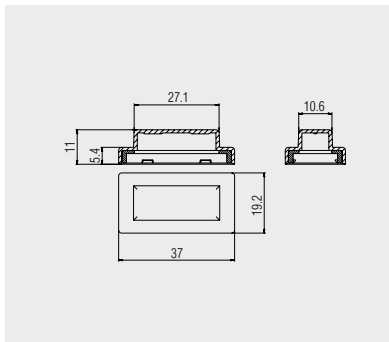

Transparent PVC-protection cap for single-pole switches of basic types 1830, 1831, 1833 and 1838. Serves as dust and water protection of the actuation side.



Protection cap  
203.201.011

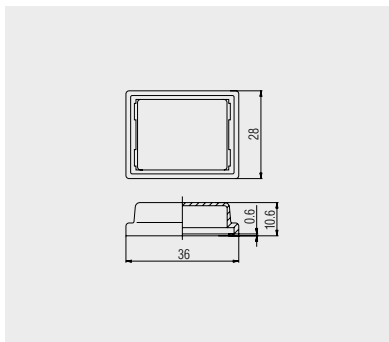

Transparent PVC-protection cap for double-pole switches of basic types 1832, 1834, 1835 and 1839 with frame length 33.2 mm. Serves as dust and water protection of the actuation side.

ROCKERSWITCHES

PUSHBUTTON SWITCHES

TOGGLE SWITCHES

SLIDE SWITCHES

ROTARY SWITCHES

FOOT SWITCHES

TACT AND KEY SWITCHES

SNAP-ACTION SWITCHES

MICRO-SIGNAL SWITCHES

SENSORS

ECO

PUSH'N'DRIVE



## SERIES 1830 - SINGLE AND DOUBLE-POLE ROCKER SWITCHES

TO 20 (4) A 250 V AC



Protection cap  
203.078.011

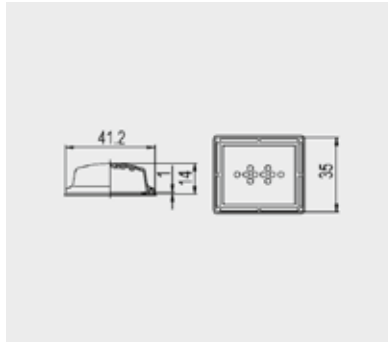

Transparent PVC-protection cap with burling. Serves as dust and water protection of the actuation side for double-pole basic types 1832, 1834, 1835 and 1839 with standard flange length 30 mm.



Dummy cap  
203.145.051



Housing  
217.132.031

Housing and dummy cap for double-pole size of basic types 1830, 1831, 1833, 1837 and 1838 made of PA black.

Housing and dummy cap must be assembled by the customer and make only sense in combination



Dummy cap  
203.146.051



Housing  
217.127.491

Housing and dummy cap for double-pole size of basic types 1832, 1834, 1835 and 1839 made of PA black.

Housing and dummy cap must be assembled by the customer and make only sense in combination



Block connector  
217.954.011

Block connector for cable connection for the double-pole versions of the rocker switch series 1830 und 1930.

Used with the standard timer plug AMP 0-927 936-1

A	1	2	3	4
	Empfohlener Ausschnitt für Rastbefestigung (Grat gegenüber Bestückungsseite) recommended cut-out for snap-in fixing (edge opposite to snap-in direction)	Wanddicke wall thickness 0.75 to / bis 1.25 1.25 to / bis 2 2 to / bis 3	Ausschnittlänge length of cut-out 30 -0.1 30.2 -0.1 30.6 -0.1	Ausschnittbreite width of cut-out 22 +0.2 22 +0.2 22 +0.2

B

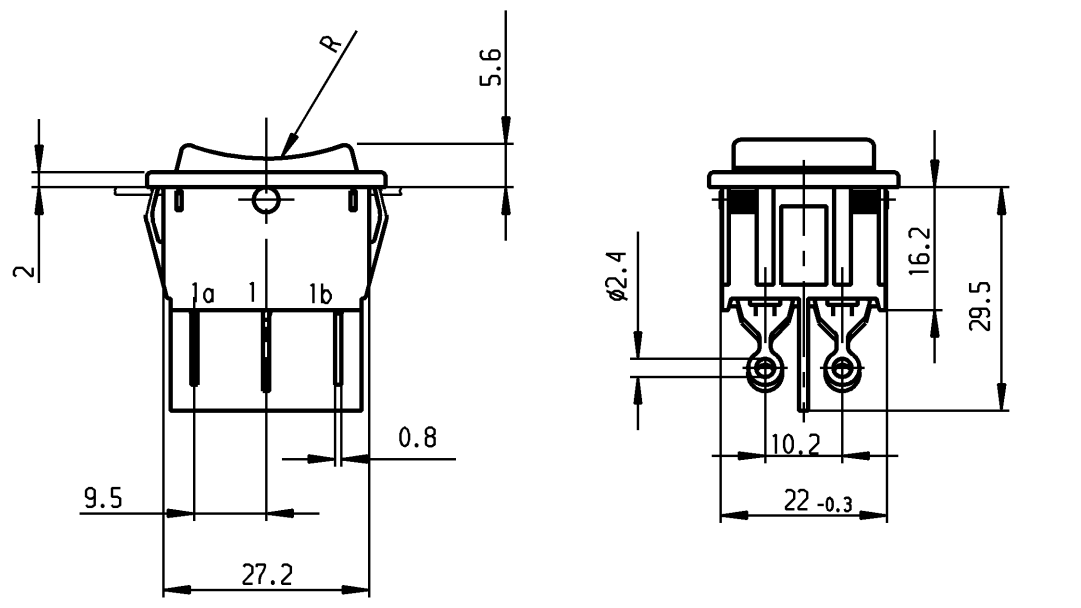

**VERTRAULICH-CONFIDENTIAL**  
 © Alle Rechte bei Marquardt, auch fuer den Fall von Schutzrechtsanmeldungen. Jede Verfuegungsbefugnis, wie Kopier- und Weitergaberecht, bei uns.  
 © This document is the exclusive property of Marquardt. Without our consent, it may not be reproduced or given to third parties.

C

D

Aufschrift  
Marking



Herstellort/-jahr/-woche  
nach DIN EN 60062

code of manufacture:  
place / year / week  
acc. to DIN EN 60062

Umschalter 2-polig  
Ausstellung in der Mitte

Für Geräte der Klasse II geeignet  
Mit integrierter Systemabdeckung

DPDT

with centre-off  
suitable for appliances of class II  
with integrated system cover

Schutzvermerk  
nach DIN 34 beachten  
COPYRIGHT RESERVED

Für Form und Lage FOR SHAPE AND LOC.	Für Winkel FOR ANGLE ± 2°	Allgemeintoleranzen UNTOLERANCED DIMENSIONS			Pause COPY	Blatt SHEET		Typ K	Zeichn./DRAWING NO. 1839.0105	Index																																															
		PROJECTION	Abmasse und Nennmassbereiche Angaben in mm	Laengen LENGTH		Radien RADI	Original DIN				Maßstab SCALE																																														
		<table border="1"> <tr><td>0-6</td><td>± 0.2</td><td>± 0.2</td><td>± 0.2</td></tr> <tr><td>&gt;6-15</td><td>± 0.4</td><td>±</td><td>±</td></tr> <tr><td>&gt;15-30</td><td>± 0.4</td><td>±</td><td>±</td></tr> <tr><td>&gt;30-70</td><td>± 0.6</td><td>±</td><td>±</td></tr> <tr><td>&gt;70-120</td><td>±</td><td>±</td><td>±</td></tr> <tr><td>&gt;120-200</td><td>±</td><td>±</td><td>±</td></tr> </table>	0-6	± 0.2	± 0.2	± 0.2	>6-15	± 0.4	±	±	>15-30	± 0.4	±	±	>30-70	± 0.6	±	±	>70-120	±	±	±	>120-200	±	±	±	<table border="1"> <tr><td>0-6</td><td>± 0.2</td><td>± 0.2</td><td>± 0.2</td></tr> <tr><td>&gt;6-15</td><td>± 0.4</td><td>±</td><td>±</td></tr> <tr><td>&gt;15-30</td><td>± 0.4</td><td>±</td><td>±</td></tr> <tr><td>&gt;30-70</td><td>± 0.6</td><td>±</td><td>±</td></tr> <tr><td>&gt;70-120</td><td>±</td><td>±</td><td>±</td></tr> <tr><td>&gt;120-200</td><td>±</td><td>±</td><td>±</td></tr> </table>	0-6	± 0.2	± 0.2	± 0.2	>6-15	± 0.4	±	±	>15-30	± 0.4	±	±	>30-70	± 0.6	±	±	>70-120	±	±	±	>120-200	±	±	±	± 10%	A4	1:1			
0-6	± 0.2	± 0.2	± 0.2																																																						
>6-15	± 0.4	±	±																																																						
>15-30	± 0.4	±	±																																																						
>30-70	± 0.6	±	±																																																						
>70-120	±	±	±																																																						
>120-200	±	±	±																																																						
0-6	± 0.2	± 0.2	± 0.2																																																						
>6-15	± 0.4	±	±																																																						
>15-30	± 0.4	±	±																																																						
>30-70	± 0.6	±	±																																																						
>70-120	±	±	±																																																						
>120-200	±	±	±																																																						
c	64508	20.08.09	hhe	g	CAD Medusa		Z	Geraeteschalter Appliance Switch																																																	
b	35777	12.03.03	hhe	e	gez./DRAWN BY 08.10.01 grh																																																				
a	32609	08.10.01	grh	d	gepr./CHECKED BY Me j			<b>MARQUARDT</b> Marquardt GmbH, D-78604 Rietheim-Weilheim																																																	
Ausg. ISSUE	Anderung REVISION	gez. DRAWN BY	Ausg. ISSUE	Anderung REVISION	gez. DRAWN BY	Ersatz für/REPLACEMENT OF 1839.V01.168																																																			