

PROFiTEST[®] C-GB int.

Test Instrument per DIN VDE 0100

3-349-074-03
11/9.09



PROFiTEST® C Measuring and Test Instrument

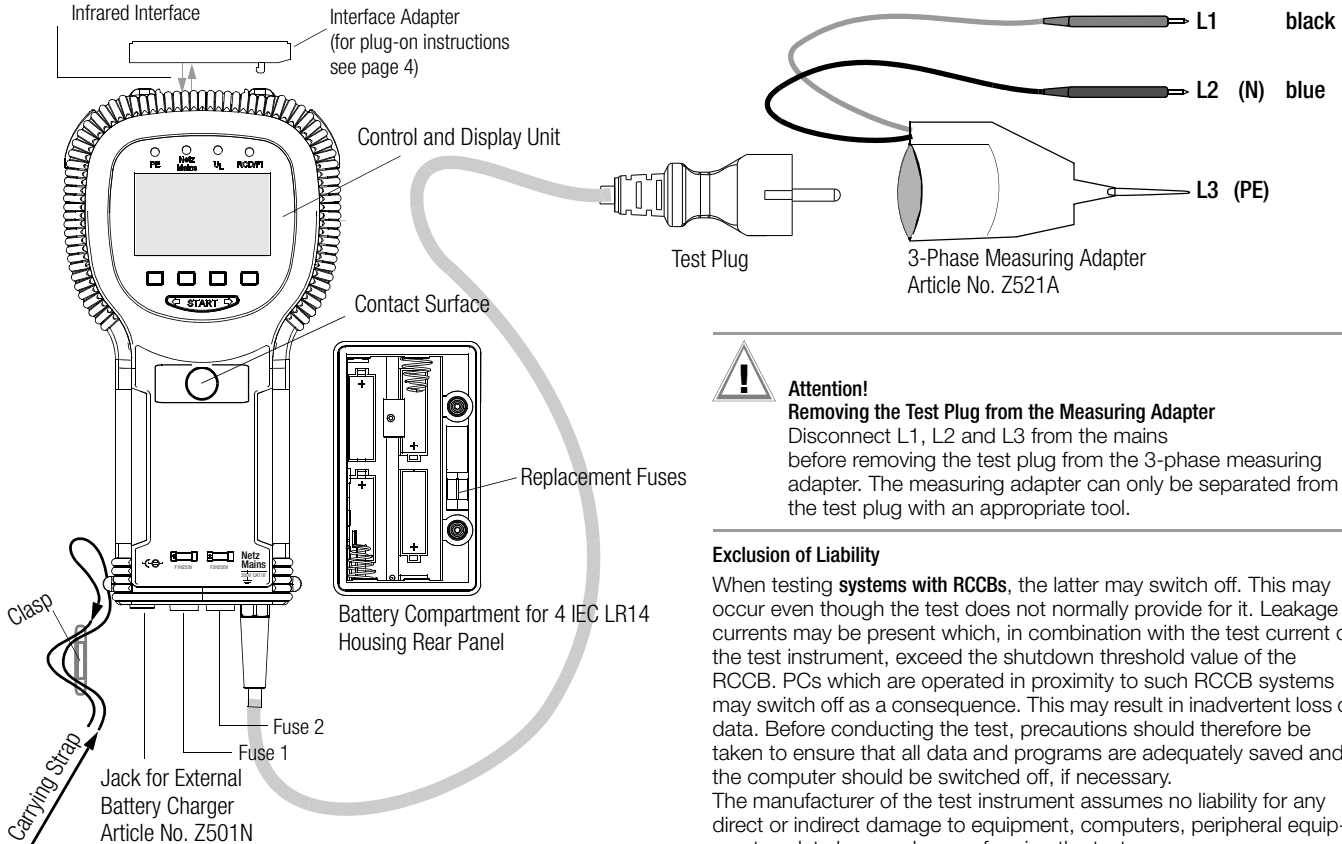

Attention!

Removing the Test Plug from the Measuring Adapter

Disconnect L1, L2 and L3 from the mains before removing the test plug from the 3-phase measuring adapter. The measuring adapter can only be separated from the test plug with an appropriate tool.

Exclusion of Liability

When testing **systems with RCCBs**, the latter may switch off. This may occur even though the test does not normally provide for it. Leakage currents may be present which, in combination with the test current of the test instrument, exceed the shutdown threshold value of the RCCB. PCs which are operated in proximity to such RCCB systems may switch off as a consequence. This may result in inadvertent loss of data. Before conducting the test, precautions should therefore be taken to ensure that all data and programs are adequately saved and the computer should be switched off, if necessary. The manufacturer of the test instrument assumes no liability for any direct or indirect damage to equipment, computers, peripheral equipment or data bases when performing the tests.

PROFiTEST[®]C Control and Display Unit

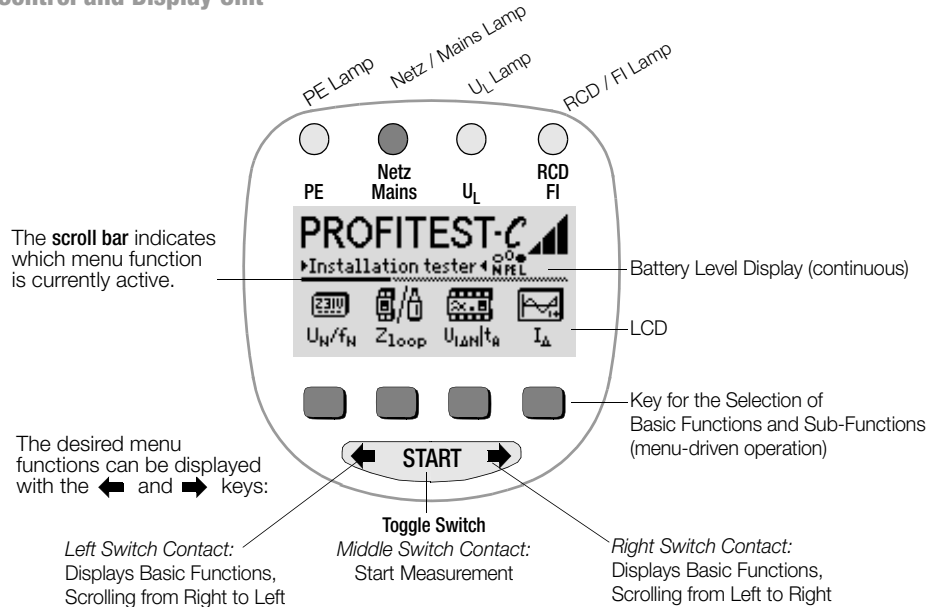

LCD	Significance	LCD	Significance
	No mains connection		2-pole mains connection or interrupted N conductor L at the plug is connected to L at the outlet.
	3-pole mains connection L at the plug is connected to L at the outlet.		2-pole mains connection or interrupted N conductor L at the plug is connected to N at the outlet. Error for polarized plug/outlet systems
	3-pole mains connection L at the plug is connected to N at the outlet. Error for polarized plug/outlet systems		Error: PE conductor is apparently interrupted. Perform contact test!

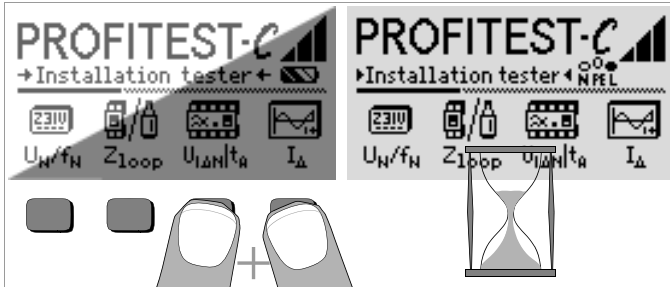

LCD after Switching on the Instrument

Please proceed as follows if the LCD display is not legible, i.e. too bright or too dark, after switching on the test instrument:

- 1 Simultaneously press the two right-hand keys to delete the memory which might be faulty.
- 2 Wait a few seconds to allow the display to be updated.
- 3 Readjust the contrast if necessary, see page 9.

Instructions for the Plug-on of the Accessory Adapter

- Interface converter IrDa-USB (Z501J)
- ◇ Connect the adapter with the IR interface of the test instrument, see drawing on page 2: Insert the guide rail of the adapter in the opening provided on top of the tester so that the adapter is located in the middle of the housing, resting on the two rubber cushions. Then push the adapter down to ensure that it is safely fastened.

PC software WinProfi for communication with PROFITEST®C

The PS3 CD-ROM includes the software WinProfi with the following content and functions:

- up-to-date test instrument software
 - for loading another language
 - for loading software version updates,
- Exchange of measured data between test instrument and PC
- Preparation, print-out and filing of test reports at the PC

The following interface adapter is required for communication between test instrument and PC:

- IrDa-USB Converter (Z501J): IrDa (tester) – USB (PC)

Data Backup

Measurement data and electrical circuit assignments can be safely stored in a RAM as long as the associated battery supplies the required voltage. We advise you to regularly transmit your stored data to a PC in order to prevent potential loss of data in the test instrument. We assume no responsibility for any data loss.

For data processing and management we recommend the following PC software programs:

- PS3 (documentation, management, report generation and monitoring of deadlines)
- PC.doc-WORD (report and list generation)
- PC.doc-ACCESS (test data management)

Contents	Page
1 Applications	6
2 Safety Features and Precautions	6
3 Initial Start-Up	7
3.1 Switching the Instrument on and Testing the Batteries	7
3.2 Installing and Replacing Batteries	7
3.3 User Guide in a Different Language	7
3.4 Selecting a Menu and Configuring Basic Settings	8
3.5 Downloading a Software Update, Managing Report Data	10
4 General Operation	13
4.1 Connecting the Instrument	13
4.1.1 Checking Earthing Contact Outlets for Correct Connection	13
4.2 Automatic Settings, Monitoring and Shutdown	13
4.3 Measurement Value Display	14
4.4 Database Functions	14
4.4.1 Creating a Data Record – Data Function	14
4.5 Saving Measurement Values – STORE Functions	15
4.5.1 Querying Data Records – View Function	16
4.5.2 Deleting a Memory Address – Data Function	16
4.5.3 Delete All Memory Addresses – Data Function	17
4.6 Online Help	18
4.7 Print Function	18
5 Measuring Line Voltage, Frequency, Phase Angle and Phase Sequence	19
5.1 2-Pole Connection with Test Plug	19
5.2 3-Pole Connection with Test Plug and 3-Phase Measuring Adapter (accessory)	19
5.3 Voltage Measurement	19
6 Testing RCDs	20
6.1 Measuring Contact Voltage (in relation to nominal residual current) with $\frac{1}{3}$ Nominal Residual Current	20
6.2 Measuring Contact Voltage and Trip Test with Nominal Residual Current	21
6.3 Special Tests for Systems and RCCBs	22
6.3.1 Testing Systems and RCCBs with Rising Residual Current	22
6.3.2 Testing RCCBs with 5 Times $I_{\Delta N}$ (10 mA, 30 mA and 100 mA)	23
6.3.3 Testing RCCBs with 150 mA	23
6.3.4 RCCB Non-Trip Test with 50% $I_{\Delta N}$ for 2 Seconds Prior to Actual Tripping	24
6.4 Testing Special RCCBs	24

Contents	Page
6.4.1 Systems with Selective RCCBs	24
6.4.2 Type G RCCBs	25
7 Testing Breaking Conditions for Overcurrent Protective Devices, Measuring Loop Impedance and Calculating Short-Circuit Current (Z_{Loop} function)	26
7.1 Measuring with Negative or Positive Half-Wave	27
7.2 Measuring Loop Impedance with a 15 mA Test Current Without Tripping RCCBs	27
7.3 Evaluating the Measurement Values	28
7.4 Measuring Line Impedance	28
8 Earthing Resistance (R_E function)	29
8.1 Performing Measurements	29
8.2 Setting Limit Values	30
8.3 Evaluating the Measurement Values	30
9 Characteristic Values	31
9.1 Lamp Functions	33
10 List of Abbreviations and their Meanings	33
11 Appendix	34
11.1 Table of Loop Impedance Values	34
11.2 Table of Earthing Resistance Values	34
11.3 Table of Minimum Display Values for Short-Circuit Current for the Determination of Current Ratings for Various Fuses and Circuit Breakers for Systems with a Nominal Voltage of $U_N=230/400$ V	35
12 Maintenance	36
12.1 Self-Test	36
12.2 Battery Operation	36
12.3 Fuses	37
12.4 Housing	37
13 Repair and Replacement Parts Service, DKD Calibration Lab and Rental Instrument Service	38
14 Product Support	38

1 Applications

The PROFiTEST[®]C measuring and test instrument allows for rapid and efficient testing of protective measures in accordance with DIN VDE 0100, ÖVE-EN 1 (Austria) and SEV 3755 (Switzerland), as well as other country-specific regulations. The microprocessor controlled device complies with regulations set forth in IEC 61557/EN 61557/VDE 0413.

Part 1: General requirements

Part 3: Loop resistance measuring instruments

Part 6: RCDs in TT and TN systems

Part 7: Phase sequence indicators

The test instrument is especially suited for:

- Set-up
- Initial start-up
- Periodic testing
- Troubleshooting in electrical systems

All of the values required for approval reports (e.g. for ZVEH) can be measured with a test set consisting of the PROFiTEST[®]C and the METRISO[®]C. Measurement values can be transmitted to a PC, and printed out or archived with the infrared data interface which has been integrated into the PROFiTEST[®]C. This is very important, especially where product liability is concerned. The applications range of the PROFiTEST[®]C includes all alternating and 3-phase current systems with 230 V line voltage and 16²/₃ Hz, 50 Hz and 60 Hz line frequencies.

The following can be measured and tested with the PROFiTEST[®]C:

- Voltage
- Frequency
- Phase sequence
- Loop impedance
- RCDs
- Earthing resistance

Seal of Approval



2 Safety Features and Precautions

The PROFiTEST[®]C electronic measuring and test instrument has been manufactured and tested in accordance with safety regulations IEC/EN 61010-1/VDE 0411-1 and EN 61557.

If used for its intended purpose, the safety of the operator and the instrument are assured.

Read the operating instructions carefully and thoroughly before using your instrument, and observe all instructions included therein. Make sure that the operating instructions are available to all users of the instrument.

Tests may only be performed under the supervision of a qualified electrician. The user must be instructed by a qualified electrician concerning performance and evaluation of the test.



Note

Manufacturers and importers of electrical medical devices must provide documentation for the performance of maintenance by trained personnel.

The measuring and test instrument may not be used:

- If the battery compartment cover has been removed
- If external damage is apparent
- With damaged connector cables and measuring adapters
- If it no longer functions flawlessly
- After excessive stress due to transport
- After lengthy periods of storage under unfavorable conditions (e.g. humidity, dust, extreme temperatures)

Meanings of Symbols on the Instrument



Warning concerning a point of danger
(Attention: observe documentation!)



Protection class II device

CAT III

Measuring category III device



9 V DC charging socket
for NA102 charging adapter (article no. Z501N)

3 Initial Start-Up

3.1 Switching the Instrument on and Testing the Batteries

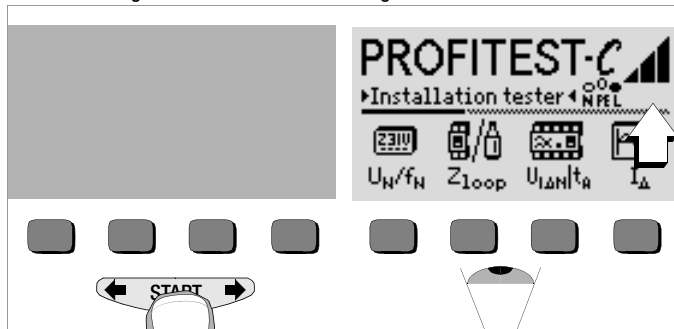

The instrument can be switched on by pressing any key.

Five battery symbols ranging from depleted to fully charged continuously indicate the current battery level in the main menu.

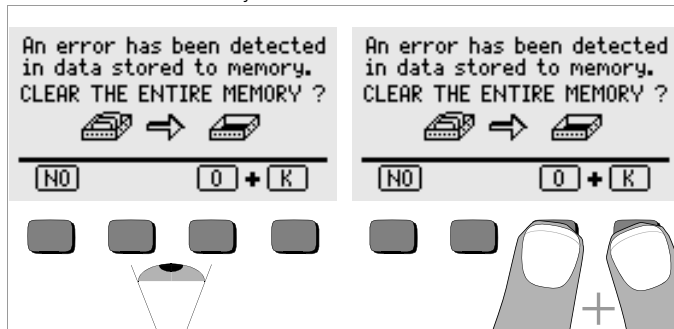

If the above message appears during initial start-up – non-defined data in memory – the contents of the memory must be entirely deleted.

3.2 Installing and Replacing Batteries

New batteries must be installed before initial start-up, or when **only one solid segment remains in the battery symbol**.

The contents of the memory remain intact during battery replacement (back-up time: approximately 5 to 10 minutes).



Attention!

The instrument must be disconnected from the measuring circuit (mains) at all poles before the battery compartment is opened. Pull the test plug!

Four 1.5 V baby cells in accordance with IEC LR14 are required for operation of the PROFITEST[®]C. Use alkaline-manganese batteries only. Rechargeable NiCd or NiMH batteries may be used as well. Be absolutely sure to refer to chapter 12.2, page 37, regarding the charging cycle and the charging adapter.

Always replace the batteries in complete sets.

Dispose of batteries in an environmentally sound fashion.

- Loosen the two slotted screws at the battery compartment cover on the housing rear panel and remove the cover.
- Insert four 1.5 V baby cells making certain they are poled in accordance with the symbols. Insert the two batteries which are half covered by the housing first.
- Replace the cover and retighten the screws.



Attention!

The instrument may not be operated if the battery compartment cover has not been installed and properly tightened!

3.3 User Guide in a Different Language

By performing a software update it is possible to load another language for the user guide than the one included in the scope of supplies. Any language currently available is proposed for choice when WinProfi is being installed, see chapter 3.5.

3.4 Selecting a Menu and Configuring Basic Settings

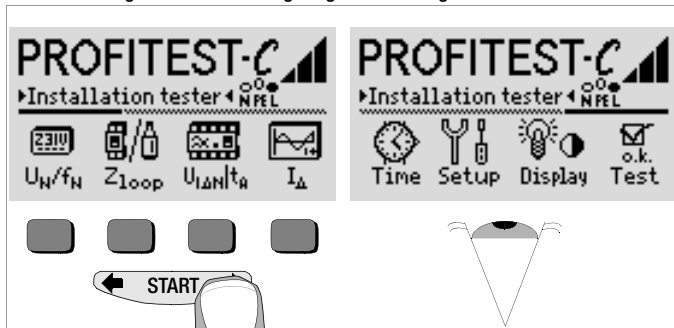

Press the \leftarrow or the \rightarrow key in order to display the desired measuring function, the desired device settings or the database functions.

Default Settings – Last Used Settings

A selection can be made here as to whether the menus will be displayed according to the default settings, or if the last opened menus should be displayed.

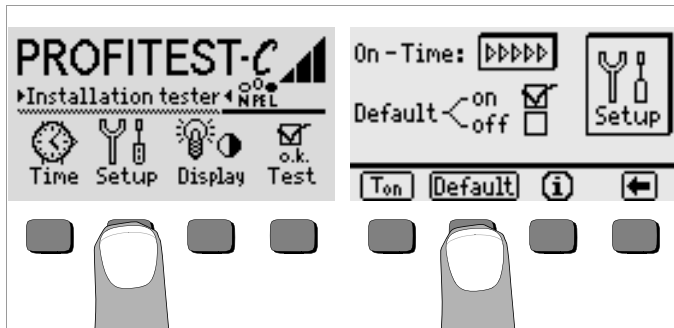

- Activate the setup key.
- Press the default key:
- on ✓ Settings such as $I_{\Delta N}$, half-waves etc., as well as T_{on} (= 20 sec.) are reset to the default settings when the instrument is switched on.
- off ✓ The last used settings remains when the instrument is switched on.
- Exit the setup menu by pressing the \leftarrow key.

Setting On-Time, Manual Shutdown

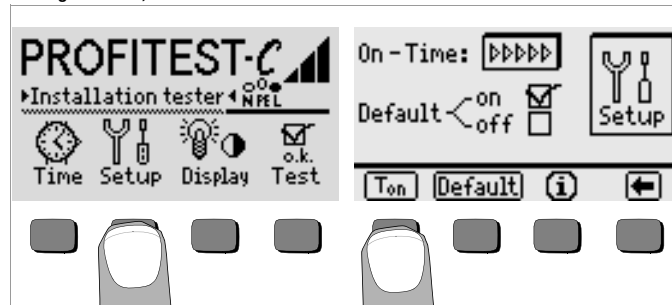

- Activate the setup key.
- Press the T_{on} key and then the 10sec, 20sec, 30sec or 60sec key depending upon the desired duration after which the test instrument should switch off automatically. The ">>>>>" setting indicates that automatic shutdown will occur. The selected setting has a substantial influence on battery service life.
- Exit the setup menu by pressing the \leftarrow key.

The instrument can be switched off manually by simultaneously activating the two outermost softkeys.

Background Illumination and Contrast

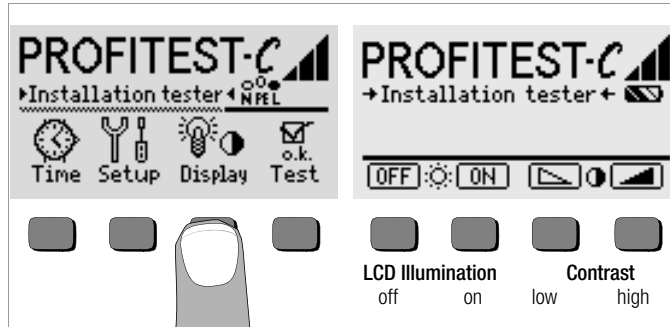

- ⇨ Activate the Display key.
 - ⇨ In order to extend battery service life, display illumination can be switched off entirely.
Press the corresponding softkey to this end.
- If LCD illumination is activated (= ON), it is automatically switched off several seconds after the last key has been activated in order to extend battery service life. As soon as a key is activated again, illumination is switched back on.
- ⇨ Contrast can be optimized with the two keys at the far right.
 - ⇨ The setup menu is exited by pressing the **START** key, and the selected settings become effective.

Setting the Clock

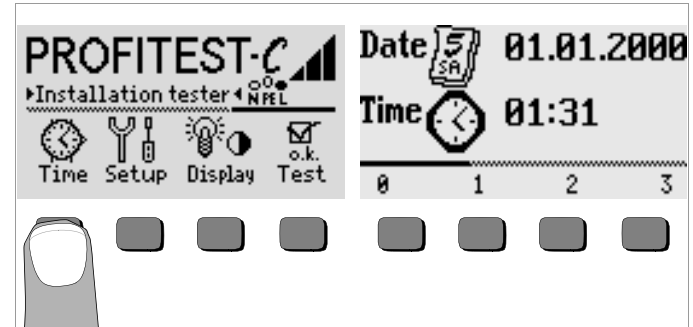

- ⇨ Activate the Time key.
- ⇨ The cursor appears at the first digit in the date. Enter the desired numeral with one of the softkeys.
Numerals which do not appear can be displayed with the help of the **←** or the **→** key. Each time a numeral is selected, the cursor moves to the next position to the right.
- ⇨ Date and time are saved as soon as the last numeral has been entered.
- ⇨ The setup menu is exited by pressing the **START** key, and the selected settings become effective.

3.5 Downloading a Software Update, Managing Report Data

If you require an updated test instrument software, it can be downloaded with the help of WinProfi PC software. The data file with the desired software version is transmitted to the test instrument via the serial interface. The previously installed language is overwritten.



Note

This software includes all of the functions required for communications between the PROFITEST[®]C and the PC. A description of the program is included in the online user's manual which can be accessed from WinProfi.

A Install WinProfi to the PC and Start the Program

- First install the software to your PC. Insert the CD into the CD drive, for example drive E. Execute the file **E:\GMCDEMO**
- Click the globe icon.
- Follow the instructions which appear at the monitor. The program is added to your START menu after installation.

- Establish a connection between your PC and the PROFITEST[®]C test instrument by using the IrDa-USB converter.
- Start WinProfi.
- Switch on the test instrument.
- Set the on-time period of the PROFITEST[®]C to „>>>>>“ to give you enough time for adjusting the settings in WinProfi before the test instrument switches off again automatically, see chapter 3.4.

Display or print out online user's manual

The online manual contains information concerning the software which is not included in these operating instructions.



WinProfi Software

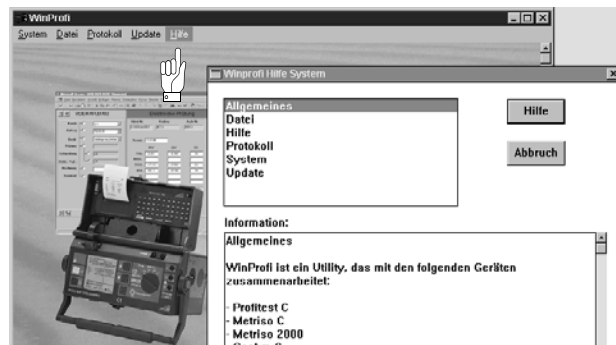

B Prerequisites for Software Update or Data Exchange

- Find the interface to which the PROFiTEST[®]C is connected.

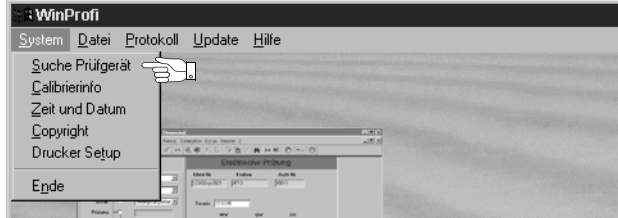

Note

Always start this function first, **before performing an update or changing report templates.**

After starting this function, WinProfi loads the report files specifically necessary for the connected instrument. Due to the fact that WinProfi has been created for use with several types of test instruments, incorrect test reports may otherwise be loaded, or erroneous options may be made available.

- Query information regarding current software version.

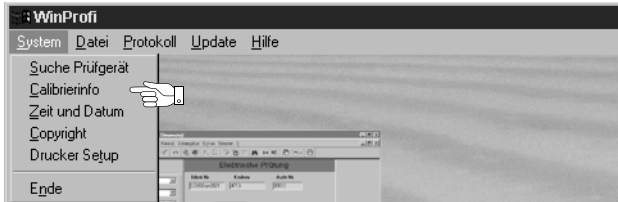

C Transmission of a Software Update to the Test Instrument



- PC: Select the **Update All** function from the **Update** menu. Follow the instructions which appear at the monitor.
Depending upon the utilized PC, transmission takes from 1 to 2 minutes.

The NETZ/MAINS LED of the PROFiTEST[®]C test instrument lights up green and indicates that the instrument is ready to receive data. If the PC and the test instrument are correctly synchronized, the same LED lights up yellow. During programming sequences, the U_L and RCD/FI LEDs light up red and the NETZ/MAINS LED lights up yellow in alternating order. Upon completion of data transmission, the NETZ/MAINS LED briefly lights up green, afterwards all LEDs go out.

The message „Transmission done“ appears on the computer screen.



Attention!

The instrument may not, under any circumstances, be switched off during transmission, nor may the connection between the instrument and the PC be interrupted!

D Managing Report Data

- Establish a connection between your PC and the PROFiTEST®C test instrument by using the IrDa-USB converter.
- Start WinProfi.
- Switch on the test instrument.
- Set the on-time period of the PROFiTEST®C to „>>>>>>“ to give you enough time for adjusting the settings in WinProfi before the test instrument switches off again automatically, see chapter 3.4.
- Send or receive a data file



• Print data

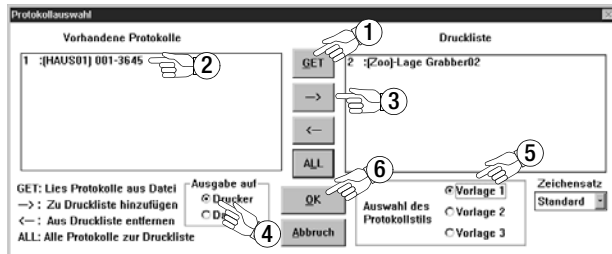

• Edit or transmit report templates



4 General Operation

4.1 Connecting the Instrument

Connect the instrument to the mains with the test plug if the system to be tested is equipped with earthing contact outlets. Voltage between phase L and protective earth PE may not exceed 253 V!

Poling at the plug can be ignored. The instrument determines the positions of phase L and neutral N, and automatically reverses poles if necessary. This does not apply to the following measurements, in order to allow for conscious determination of poling at the plug:

- Voltage measurement in switch position U_{L-PE}
- Phase sequence measurement

The position of phase L is identified on the plug.

If measurements are taken at 3-phase outlets, at distribution cabinets or at permanent connections, use the 3-phase measuring adapter (see page 2), and attach it to the test plug.

4.1.1 Checking Earthing Contact Outlets for Correct Connection

Checking earthing contact outlets for correct connection prior to protective measures testing is simplified with the error recognition system integrated in to the test instrument. The instrument displays faulty connections as follows:

- **Impermissible line voltage (< 170 V or > 253 V):**
The NETZ/MAINS lamp blinks red and the measuring function is disabled.
- **Protective conductor not connected, or potential to earth ≥ 150 V at > 45 Hz:**
When contact is made with the contact surface, the PE lamp lights up red. *Measurement is not disabled by the illuminated lamp.*
- **Neutral conductor N is not connected (2-pole connection):**
The NETZ/MAINS lamp blinks green.
See "Lamp Functions" on page 34.

In countries with polarized electrical outlets (Great Britain, France, Switzerland, Czech republic etc.), it is advantageous to be able to recognize at first glance whether or not L and N have been correctly connected to the outlet, see table on page 3. To date, it has been necessary to initialize the U_{L-PE} voltage measuring function to this end. As of software version AI,

symbols are already displayed in the test instrument's start menu which provide clear-cut information regarding connection of the outlet to the mains.



Attention!

Reversal of N and PE in TN systems cannot be recognized and is not indicated.

Reversal of N and PE in electrical systems equipped with RCCBs can be detected by means of loop impedance measurement. The RCCB is not tripped during measurement.

4.2 Automatic Settings, Monitoring and Shutdown

The PROFITEST[®]C makes appropriate settings for all of the operating conditions it is able to determine on its own. It tests voltage and frequency at the electrical system.

Line voltage fluctuations have no influence on measurement results.

The contact voltage which is generated by the instrument is monitored during each measurement. If contact voltage exceeds the 50 V limit value, the measurement is interrupted immediately. The U_L amp lights up red.

If battery voltage drops to below 4.6 V, the instrument cannot be switched on, or it is immediately switched off.

Measurement is interrupted automatically, or the measuring sequence is disabled (except for voltage measuring ranges and phase sequence measurement):

- If impermissible line voltages occur (< 170 V, > 253 V) during measurements, for which line voltage is required
- If excessive temperatures prevail within the instrument
Impermissible temperatures usually do not occur until after approximately 50 measuring sequences have been performed once every 5 seconds when the Z_{Loop} function has been selected.
If an attempt is made to start a new measuring sequence, an appropriate message appears at the LCD.

The instrument switches itself off automatically, at the earliest after the current (automatic) measuring sequence has been completed, and after the predefined on-time has elapsed (see chapter 3.4). On-time is reset to the duration selected in the setup menu each time a key is activated.

4.3 Measurement Value Display

The following can be displayed at the LCD:

- Measurement values as abbreviations and units of measure
- The selected function
- Error messages

When automatic measuring sequences are used, the measurement values are displayed in digital format until the next measuring sequence is started, or until the instrument switches itself off automatically.

If the measuring range upper value is exceeded, the upper value is displayed and is preceded with the larger than symbol ">" in order to indicate over-ranging.

4.4 Database Functions

The displayed measurement data for each measurement can be saved to an internal database, either with or without comment. A data record must be created and allocated to a specific memory address in order to be able to assign the individual measurement values to different buildings, distribution cabinets and measuring circuits.

4.4.1 Creating a Data Record – Data Function

- ◇ Select data.

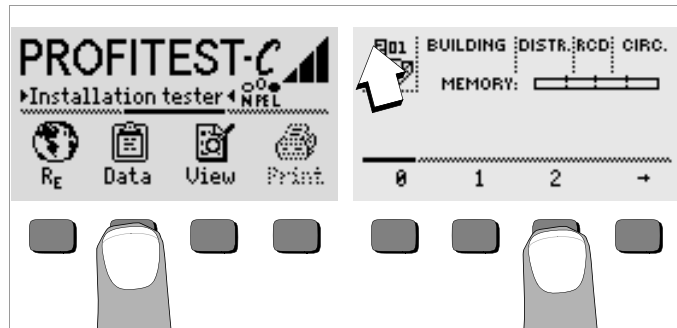

- ◇ First create the desired memory address with the help of the softkeys. After acknowledging with the **START** key (press at center), the cursor appears at the first data entry position (BUILDING).

- ◇ With the help of the softkeys, entries can be made to the BUILDING, DISTRIBUTOR, RCD No., and CIRCUIT fields one after the other, and a designation can be entered for the electrical circuit.

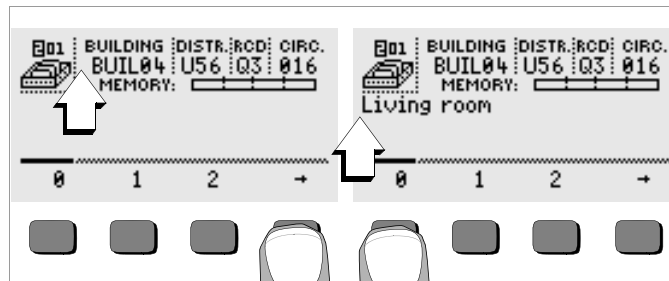

Entering Data:

Display the desired alphanumeric character by pressing the **←** or the **→** key, and then select the character with the corresponding softkey.

Control characters can be displayed in the same way and have the following meanings:

- ←: Move cursor to the left (without deleting data)
- : Move cursor to the right (without deleting data)
- ↵: Same function as the **START** key

After each character is selected, the cursor moves one position to the right. If **↵** or the **START** key is activated (press at center), the cursor moves to the next entry field. After the fields BUILDING, DISTRIBUTOR, RCD No., and CIRCUIT have been completed, and after acknowledgement has been confirmed with the **↵** softkey, the data fields are displayed as inverse images. After the **↵** softkey has been activated once again, a designation for the selected electrical circuit can be entered.

Note

These entries are required by the PC software in order to enter measurement values into the database, and to generate reports with this information automatically.

4.5 Saving Measurement Values – STORE Functions

- Start the respective measurement. The store key is displayed after the measurement instead of the INFO key.

The store key is not displayed until after a given amount of time has elapsed for measurements which are performed without the **START** key. For example, the store key is not displayed until after a given amount of time after voltage measurements so that the operator can first query the help text with the INFO key.

- The displayed measurement values are stored to the currently selected database memory address by briefly acknowledging with the STORE key. The key is briefly displayed as an inverse image during storage to memory.
- Pressing and holding the STORE key allows for the entry of a comment, and storage of the current measurement.

Entering a comment: Display the desired alphanumeric character with the **←** or the **→** key and select the desired character with the corresponding softkey.

Control characters are displayed in the same way and have the following meanings:

←: reverse and delete, ↓: same as the **START** key

After the character has been selected, the cursor moves one position to the right. Already entered characters can be deleted in reverse by pressing and holding any softkey (except for ↓).

After entry of up to 15 characters, save the measurement values and the comment by acknowledging with the **START** key (press at center). The following message appears: "Saving data".

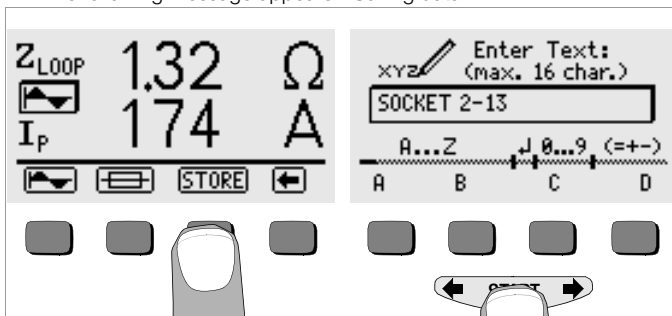

Selecting Values to be Saved to Memory for the Generation of Reports

Any number of values can be saved to memory for each electrical circuit. Consecutive number are automatically assigned to these values. Since, as a rule, only the worst value, or only a single value is required for reports, this value is determined as follows by the PC software (e.g. PS3).

Measuring Function	Values Used for Reports
$U_{L-PE}, U_{L-N}, U_{N-PE}, U_{3-w}, f$	First measured value
I_{AN}	First measured value
$U_{I\Delta N}$	Largest measured value
R_E	Only the value identified with the ! symbol
t_A	Largest measured value
I_{Δ}	First measured value
U_L	First measured value
I_{sc}	Smallest measured value
Z_{Loop}	The value associated with the smallest I_k value

4.5.1 Querying Data Records – View Function

- ◇ Select View.
- ◇ You can scroll forward through the memory addresses with the **➡** key, or backwards with the **⬅** key.
- ◇ After the memory address has been opened, the individual data records can be queried with the Prev. and Next softkeys, which have been stored to memory under consecutive numbers.

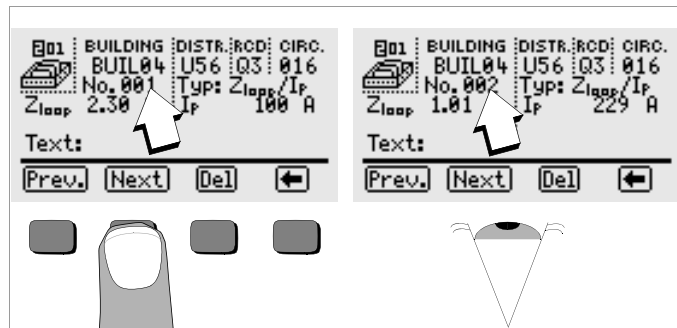
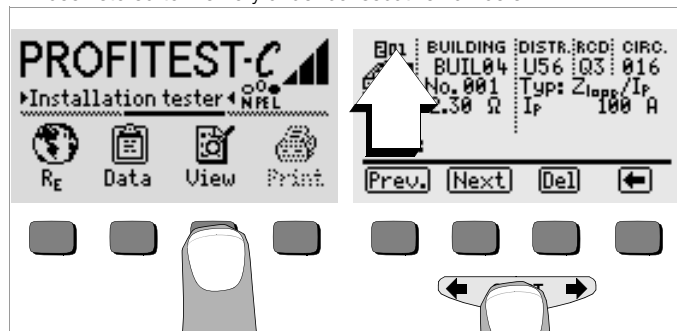

If you discover that a measurement value for the currently selected electrical circuit is missing, the required measurement can be performed immediately.

Deleting a Data Record from within a Memory Address – View Function

- ◇ Activate the Del key. No security request appears.
Data record numbering is changed as soon as an individual data record is deleted.

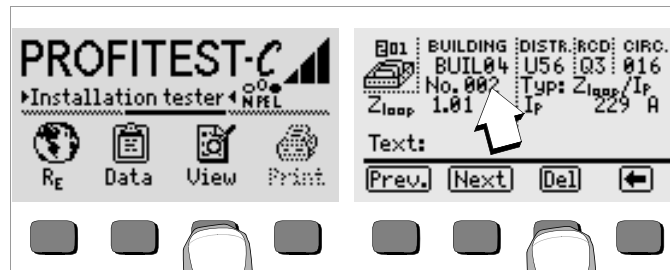

4.5.2 Deleting a Memory Address – Data Function

- ◇ First select the memory address whose contents are to be deleted with the View function.
- ◇ Then select Data.
- ◇ Enter blanks to the data fields BUILDING, DISTRIBUTOR, RCD No. and CIRCUIT. After these four fields have been entirely overwritten with blanks, they are displayed as inverse images.

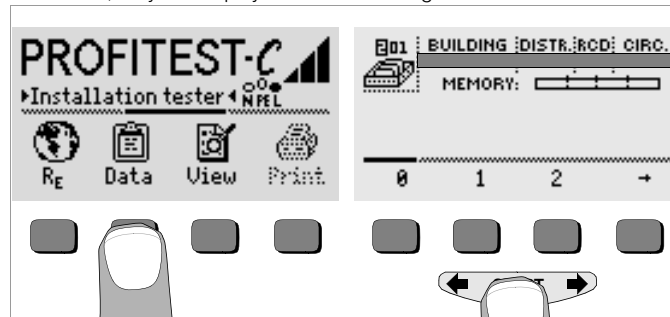

- ◇ Acknowledge with the **START** key (press at center). All data from the selected memory address are deleted.

4.5.3 Delete All Memory Addresses – Data Function

Up to 250 data records can be stored to memory. The memory is full when the triangle to the right of the “MEMORY:” parameter is entirely filled in. The entire memory, i.e. all data records from all memory addresses, can be deleted at once. We recommend uploading and saving your data to a PC before deletion.

- Select Data.

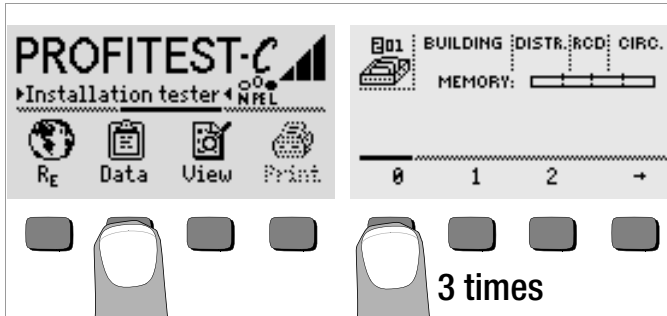

- Enter memory address “000”. An additional security request appears.

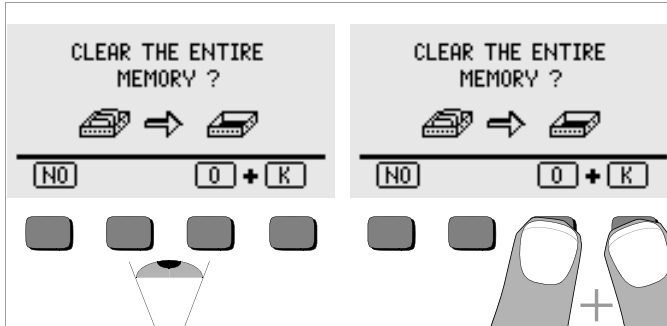

- Acknowledge by simultaneously pressing O and K to delete all data from memory. The indicator to the right of the “SPEICHER:” parameter appears empty. Memory address “001” is displayed at the left. New data can now be entered for this address, or the database can be exited (press ↵ or **START** 9 times).

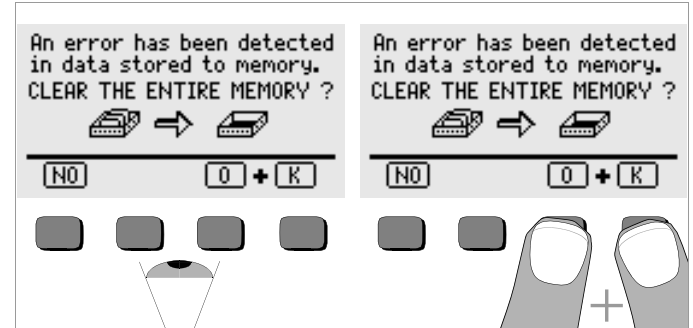

If the message shown above appears when the test instrument is switched on, you are provided with the opportunity of uploading and saving all data to a PC before deleting the memory in order to correct the error.

4.6 Online Help

Appropriate online help texts can be displayed at the LCD for each of the basic functions and sub-functions, **after the respective function has been selected in the corresponding menu**

- ↪ Press the **(i)** key to query online help.
- Press any key to exit the help function.

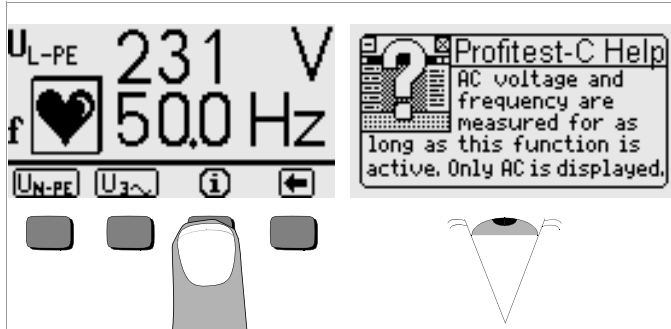

4.7 Print Function

Functions whose symbols appear in gray or which are displayed faintly, will not be available until after the next software update.

5 Measuring Line Voltage, Frequency, Phase Angle and Phase Sequence

5.1 2-Pole Connection with Test Plug

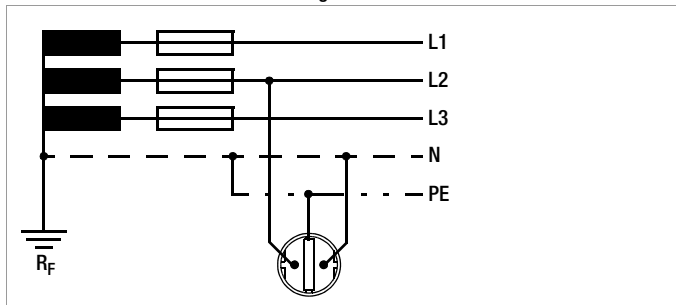

5.2 3-Pole Connection with Test Plug and 3-Phase Measuring Adapter (accessory)

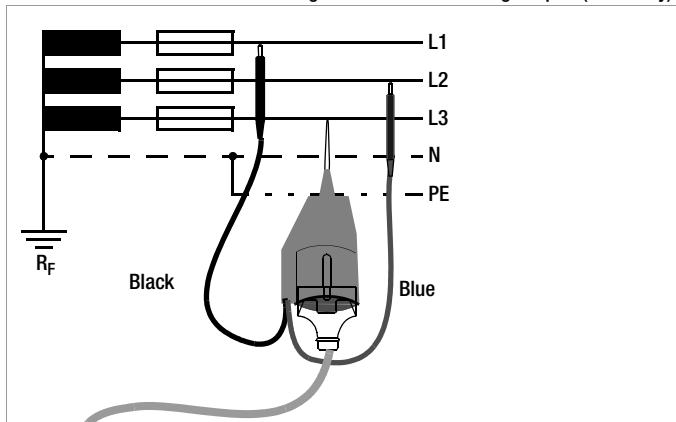

5.3 Voltage Measurement

Voltage measurement between L and PE, N and PE, L and N or phase sequence measurement with line-to-line voltage, phase angle and phase sequence starts automatically after selection of the measuring function. Voltage and frequency overflow is displayed with the "----" symbol.

Voltage Between L and PE, and Line Frequency

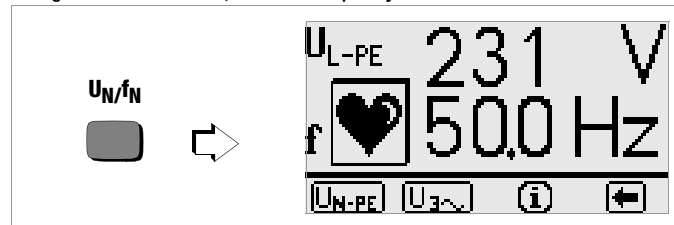

Observe correct poling at the plug for the above measurement!

Voltage Between N and PE, and Between L and N

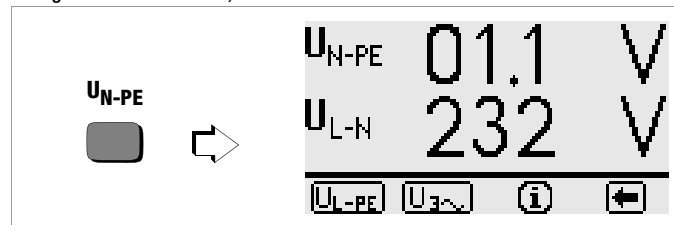

Phase Sequence Measurement

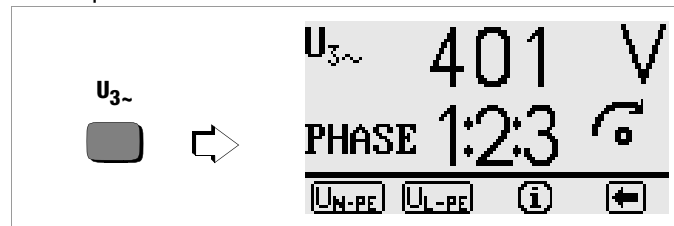

6 Testing RCDs

Testing RCDs includes visual inspection, testing and measurement. Use the PROFITEST^{®C} for testing and measurement.

Measuring Method

According to DIN VDE 0100 it must be substantiated that:

- Contact voltage which occurs at nominal residual current does not exceed the maximum allowable value for the system.
- The RCCBs are tripped within 400 ms at nominal residual current (1000 ms for selective RCCBs).

Measurement is performed by the instrument with a current having a value of less than $\frac{1}{3}$ nominal residual current in order to determine contact voltage $U_{I\Delta N}$ at nominal residual current. This prevents the RCCB from being tripped.

This measuring method offers the special advantage of being able to test contact voltage at any electrical outlet quickly and easily without tripping the RCCB.

The usual, cumbersome measuring methods for testing the effectiveness of RCDs at one measuring point, and having to substantiate that all of the other system components which require protection are reliably connected to this measuring point via the PE conductor at low resistance values are a thing of the past.

Connection

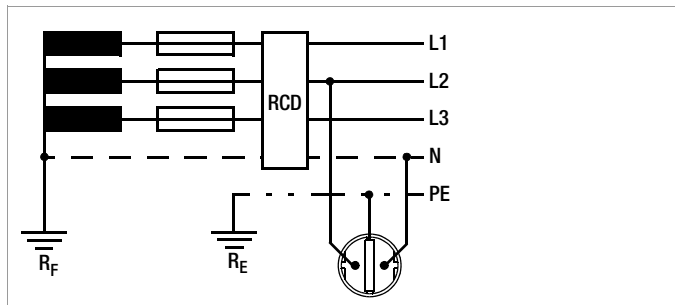

6.1 Measuring Contact Voltage (in relation to nominal residual current) with $\frac{1}{3}$ Nominal Residual Current

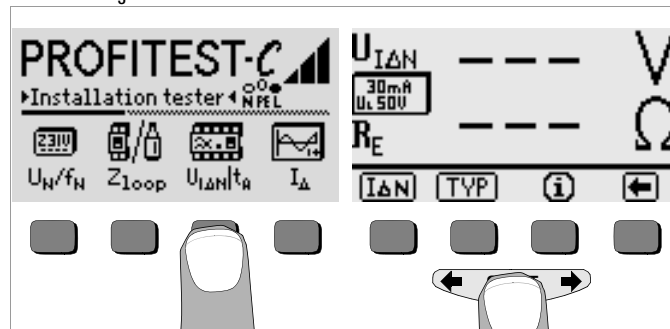

- Select contact voltage measurement with the $U_{I\Delta N}/t_R$ key.
 - Set nominal residual current for the utilized RCCB with the $I\Delta N$ key.
 - If the contact voltage limit value deviates from 50 V, or if a selective RCCB is involved, the corresponding value must first be selected by activating the TYPE key.
 - Start the measurement by briefly acknowledging with the **START** key.
- Contact voltage $U_{I\Delta N}$ (in relation to nominal residual current) and calculated earthing resistance R_E are displayed at the LCD.



Note

Interference voltages at the protective conductor PE or at the earth electrode have no influence on measuring results, as long as they are less than 25 V. Interference voltages can be measured by performing a voltage measurement with the test plug. If biasing current with relatively large values is present within the system, or if the selected test current was too large for the RCCB, tripping may occur during testing. In such cases, the following message appears at the display "Stop! No current. Check breaker".

If contact voltage $U_{I\Delta N}$ measured with $\frac{1}{3}$ nominal residual current and projected to $I_{\Delta N}$ by means of calculation is greater than 50 V (> 25 V), the U_L lamp lights up red.

If contact voltage $U_{I\Delta N}$ exceeds 50 V during testing, safety shutdown ensues.

Contact voltages of up to 99.9 V are displayed. Overflow is indicated for larger values.

Limit Values for Permissible Continuous Contact Voltage

The limit for permissible continuous contact voltage is $U_L = 50$ V for alternating voltage (international agreement).

Lower voltages are required in special applications (e.g. agricultural facilities $U_L = 25$ V).

6.2 Measuring Contact Voltage and Trip Test with Nominal Residual Current

After contact voltage has been measured, testing can be performed to ascertain whether or not the RCCB is tripped within 400 ms, or 1000 ms, at nominal residual current.

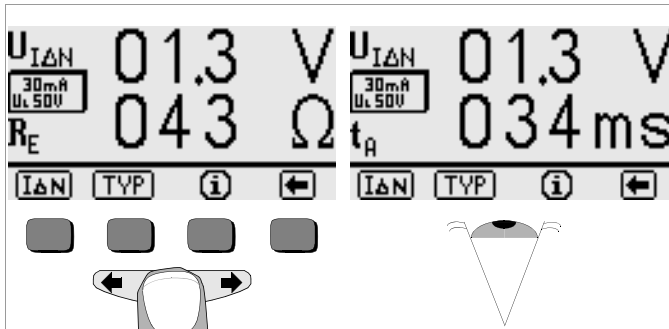

- Press the start **START** key in order to measure $U_{I\Delta N}$, and continue to hold it depressed even after the measurement value has been displayed. The trip test is started automatically after contact voltage $U_{I\Delta N}$ has been measured.

If the RCCB is tripped at nominal residual current, the NETZ/MAINS lamp blinks red (mains voltage has been interrupted), and contact voltage $U_{I\Delta N}$ and time to trip t_T appear at the display.

If the RCCB is not tripped at nominal residual current, the RCD/FI lamp lights up red.

The trip test is only required at one measuring point for each RCCB.



Attention!

If contact voltage is too great, or if the RCCB is not tripped, the system must be repaired (e.g. earthing resistance is too high, defective RCCB etc.)!

The trip test must be performed at each of the three phases (L1, L2 and L3) in order to assure flawless functioning of the RCD.



Note

Earthing resistance is automatically measured during the trip test. However, the accuracy of the measured value depends to a great extent upon the utilized measuring current. For example, the measured value is relatively inaccurate with measuring currents of 10 mA and 30 mA, because measurement resolution is reduced due to minimal current. Better results can be obtained with the R_E function (see chapter 8, page 30).



Note

Measurement Value Processing with PC Software (e.g. PS3)

Only one R_E measurement value is entered to some of the report forms. In order to assure that the PC software enters the desired

value, enter the ! symbol as the first character in the comment line after the value has been saved to memory (see chapter 4.5), for example: !Foundation earth.

6.3 Special Tests for Systems and RCCBs

6.3.1 Testing Systems and RCCBs with Rising Residual Current

Measuring Method

The instrument generates a continuously rising residual current $I_{\Delta N}$ (from 0.3 to 1.3) within the system for RCD testing.

The contact voltage and tripping current values which prevail at the moment the RCCB is tripped are stored to memory and displayed by the instrument.

The operator can select between two different contact voltages, $U_L = 25\text{ V}$ or $U_L = 50\text{ V}$, for measurement with rising residual current.

Connection

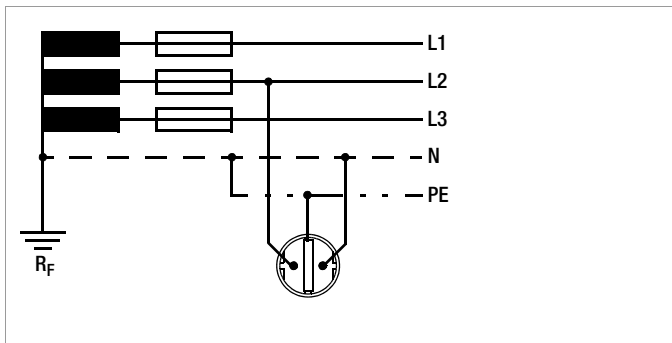

Measuring Sequence

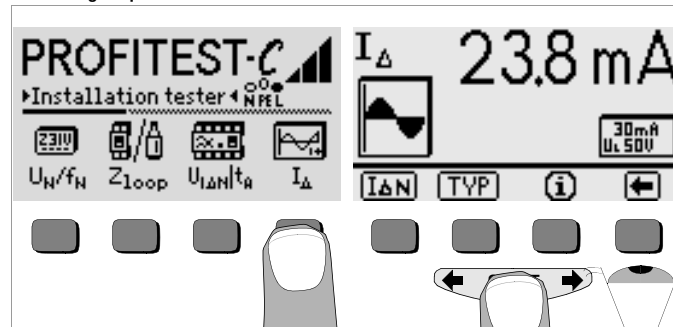

- Select measurement with rising residual current with the I_{Δ} key.
- Set nominal residual current for the utilized RCCB with the $I_{\Delta N}$ key.
- If the contact voltage limit value deviates from 50 V, or if a selective RCCB is involved, the corresponding value must first be selected by activating the TYPE key.
- Start the measurement with the **START** key.

After the measuring sequence has been started, test current generated by the instrument rises starting at a value of 0.3 nominal residual current until the RCCB is tripped. This can be observed at the sine symbol. Tripping current I_{Δ} is displayed at the LCD.

If contact voltage reaches the selected limit value ($U_L = 50\text{ V}$ or 25 V) before the RCCB is tripped, safety shutdown ensues. The U_L lamp lights up red.

If the RCCB is not tripped before the rising current reaches nominal residual current $I_{\Delta N}$, the RCD/FI lamp lights up red.



Attention!

If a biasing current is present in the system it is superimposed onto the residual current generated by the instrument during testing and influences measured values for contact voltage and tripping current.



According to DIN VDE 0100, part 610, measurement may be performed with rising current in order to evaluate RCCDs, and contact voltage for nominal residual current $I_{\Delta N}$ may be calculated based upon the measured values.

The faster and simpler method is thus generally preferred (see chapter 6.1).

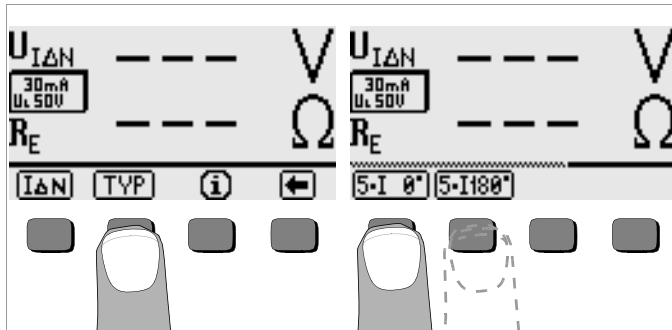
6.3.2 Testing RCCBs with 5 Times $I_{\Delta N}$ (10 mA, 30 mA and 100 mA)



Time to trip is measured with 5 times nominal residual current.



The test can be started with the positive half-wave „“, or the negative half-wave “”.

Both measurements must be performed. The longer time to trip is decisive regarding the condition of the tested RCCB. Both values must be less than 40 ms.

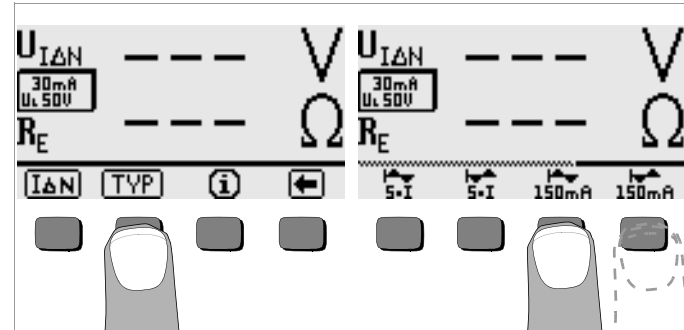
6.3.3 Testing RCCBs with 150 mA



Time to trip is measured with a 150 mA constant current.

The test can be started with the positive half-wave „“, or the negative half-wave “”.

Both measurements must be performed. The longer time to trip is decisive regarding the condition of the tested RCCB. Both values must be less than 40 ms.

6.3.4 RCCB Non-Trip Test with 50% $I_{\Delta N}$ for 2 Seconds Prior to Actual Tripping

In addition to the 30% $U_{\Delta N}$ measurement and the 100% $I_{\Delta N}$ trip test, a non-trip test with 50% $I_{\Delta N}$ and a duration of 2 seconds can be performed if desired. If the “ $\frac{1}{2} I_{\Delta N}$ ON” option has been selected, an appropriate icon appears at the display. The icon is highlighted during the 50% test in order to indicate execution.

If an RCCB is tripped during the 50% test, testing is interrupted and an appropriate message appears at the display.

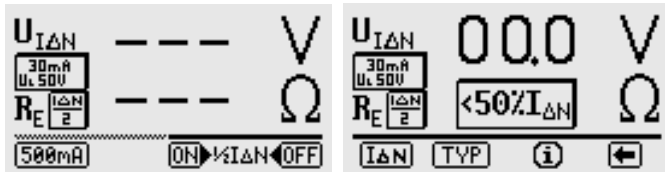

$\frac{1}{2} I_{\Delta N}$ on or off can be selected in the $v_{\Delta N}$ menu.

Display in the event of premature tripping of the RCCB

The selection as to whether or not the non-trip test is included in the measurement remains unchanged after switching the instrument off.

6.4 Testing Special RCCBs

6.4.1 Systems with Selective RCCBs

Selective RCCBs are used in systems equipped with two series connected RCCBs which are not triggered simultaneously in the event of an error. These RCCBs have a time delayed tripping response and are identified with the symbol **S**.

Measuring Method

The same measuring method is used as is the case for normal RCCBs (see chapter 6.1, page 20, and 6.3.1, page 23).

If selective RCCBs are used, earthing resistance may only be half as great as is the case for normal RCCBs. For this reason, the contact voltage displayed at the instrument is twice the actual measured value.

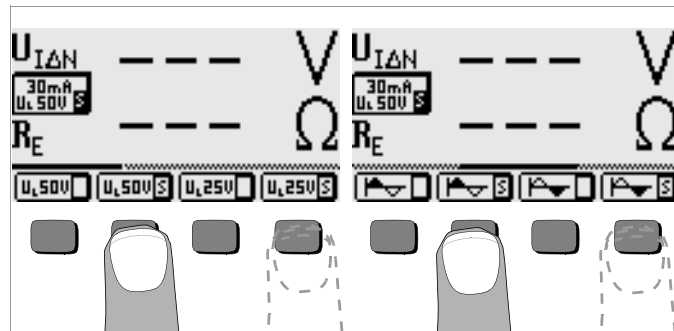

- Select the limit value for allowable contact voltage, U_L 50V **S** or U_L 25V **S**, in the respective TYPE sub-menu.

Trip Test

- Press the **START** key. The RCCB is tripped. The clock appears at the display, followed by time to trip t_T and earthing resistance R_E .

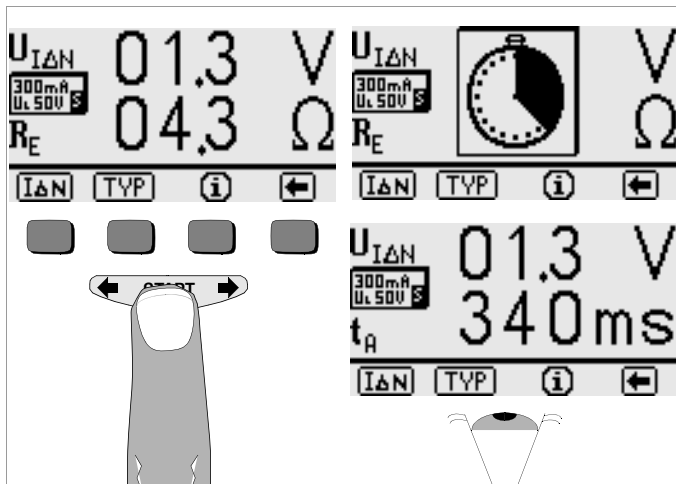

Note

Selective RCCBs have a delayed breaking response. Breaking response is influenced for a brief period (up to 30 s) by pre-loading during measurement. In order to eliminate pre-loading caused by the measurement of contact voltage, a pretest waiting period is required before the trip test can be started. After the measuring sequence has been started (trip test), a clock appears at the display.

Time to trip values of up to 1000 ms are permissible.

6.4.2 Type G RCCBs

In addition to common selective RCCBs, the special characteristics of the type G RCCB can also be tested with the PROFITEST[®]C test instrument.

- First set the instrument to the indicated nominal residual current $I_{\Delta N}$.
- Measure contact voltage and time to trip as you would for normal RCCBs.

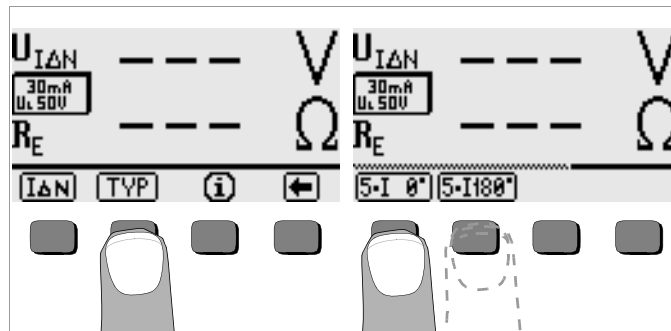

- Then select **5-I** in the TYPE sub-menu and perform the trip test with the positive half-wave. Repeat the trip test with the negative half-wave after selecting **5-I** . The longer time to trip is decisive regarding the condition of the tested RCCB.

In both cases, time to trip must lie within a range of 10 ms (minimum delay time for the type G RCCB!) to 40 ms.

Type G RCCBs with different nominal residual current values must be tested under menu item $I_{\Delta N}$ with the function selector switch in the appropriate setting.

Note

Menu selection S for selective RCCBs is not suitable for type G RCCBs.

7 Testing Breaking Conditions for Overcurrent Protective Devices, Measuring Loop Impedance and Calculating Short-Circuit Current (Z_{Loop} function)

Testing overcurrent protective devices includes visual inspection and measurement. Use the PROFITEST[®]C for measurement.

Measuring Method

Loop impedance Z_{Loop} is measured and short circuit current I_{sc} is calculated in order to determine whether or not breaking conditions are fulfilled by the overcurrent protective device.

Loop impedance is the resistance of the current loop (power distribution station – phase conductor – protective conductor) when a short-circuit to frame occurs (conductive connection between phase conductor and protective conductor). The loop resistance value determines the magnitude of short-circuit current. Short-circuit current I_{sc} may not drop to below the value set forth in DIN VDE 0100, in order to assure that the system's protective device (fuse, circuit breaker) breaks in a reliable fashion.

For this reason, measured loop impedance must be less than the maximum allowable value.

Tables including allowable display values for loop impedance, as well as minimum display values for short-circuit current for various fuse and breaker current ratings can be found in chapter 11 starting on page 35. Maximum instrument error is taken into consideration in these tables (see also chapter 7.3).

In order to measure loop impedance Z_{Loop} , the instrument uses a test current of 740 mA and a test duration of approximately 400 ms regardless of line voltage and line frequency.

If dangerous contact voltage occurs during this measurement (> 50 V), safety shutdown ensues. The measuring and test instrument calculates short-circuit current I_{sc} based upon measured loop impedance Z_{Loop} and line voltage. Short-circuit current is based upon nominal voltage 230 V (170 V ... 265 V) or on nominal voltage 120 V (80 ... 170 V).

Loop impedance can be measured either with the positive or the negative half-wave with the PROFITEST[®]C.

By using this measuring method in combination with the PROFITEST[®]DC-II measuring adapter, loop impedance can be measured in systems equipped with RCCBs without causing them to trip.

Connection

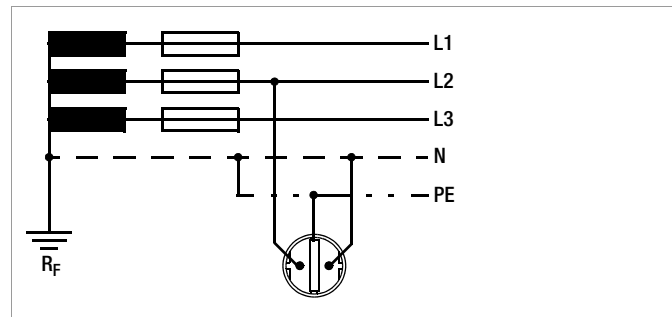

Measurement of loop impedance must be performed from all three phases (L1, L2 and L3) to the protective conductor PE for 3-phase systems in order to assure flawless functioning of the overcurrent protective device.

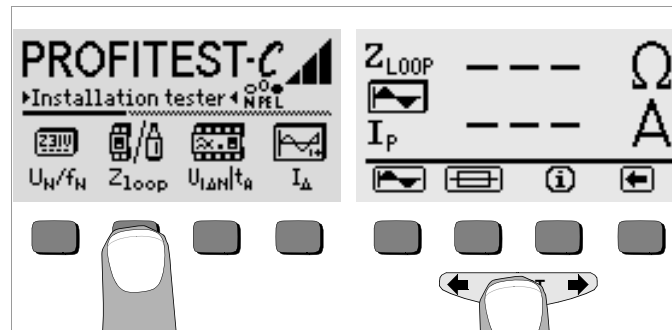

- ↪ Select loop impedance measurement with the Z_{Loop} key. A solid sine wave should be displayed as the active waveshape. Refer to the next chapter regarding measurements at RCCBs.
- ↪ Start the measurement with the **START** key.

7.1 Measuring with Negative or Positive Half-Wave

Measurement with half-waves allows for the measurement of loop impedance in systems equipped with RCCBs with the help of the PROFITEST®DC-II measuring adapter.

Connection

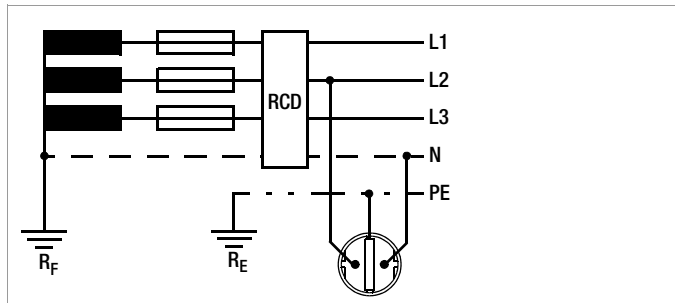

Starting the Measurement

Use the positive half-wave for the measurement of loop impedance.

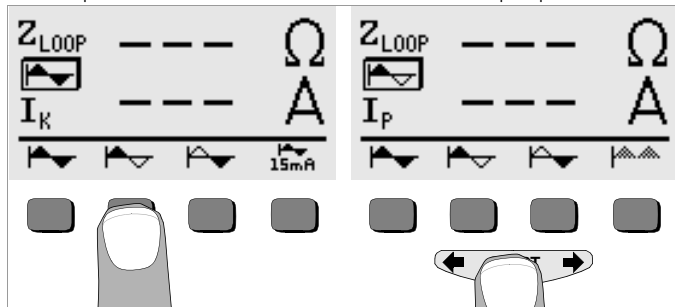

7.2 Measuring Loop Impedance with a 15 mA Test Current Without Tripping RCCBs

In order to perform measurement of loop impedance with $I_{\Delta N} \geq 30$ mA via RCCBs without causing them to trip, select the “15 mA” item in the loop impedance measurement menu.

The menu is shown in figure 1, and figure 2 shows a sample measurement.

Measuring resolution for the 15 mA measurement is only 100 mΩ instead of 10 mΩ. The duration of the measurement is extended to 1.6 seconds. The measuring range is from 0.1 Ω to 250 Ω.



Loop impedance measurements via RCCBs with $I_{\Delta N} = 10$ mA is not possible.

7.3 Evaluating the Measurement Values

Maximum allowable loop impedance Z_{Loop} can be determined with the help of the on page 35. These are the maximum values which may be displayed after taking the device's

maximum measuring error into consideration (under normal measuring conditions). Intermediate values can be interpolated.

The maximum allowable current rating for the protective device (fuse or breaker) can be determined for a nominal line voltage of 230 V with the help of the Table of Minimum Display Values for Short-Circuit Current on page 36 based upon measured short-circuit current, under consideration of the device's maximum measuring error (in compliance with DIN VDE 0100, part 610).

After measurement has been performed, allowable fuse types can be displayed by pressing the  key. The table shows maximum allowable current ratings depending upon fuse type and breaking conditions.



Note

If Z_{Loop} is greater than 100 Ω , the following error message appears: "defective F1 ...". No test current can be made available when the following error occurs: resistance too great, fuse defective or earth electrode is not connected.

7.4 Measuring Line Impedance

Line impedance can only be measured with the Z521A 3-phase measuring adapter (accessory). Connect terminal L1 (black) from the adapter to the mains phase and terminal L3 (PE) to the mains neutral conductor. Now perform a "loop measurement". Line impedance (internal system resistance) is displayed as a result of this measurement.

In order to assure that the PC software (e.g. PS3) does not recognize this procedure as a Z_{Loop} measurement, but rather as a Z_l measurement, enter the ! symbol as the first character in the comment line after the value has been saved to memory (see chapter 4.5, page 15), for example !Outlet 12.

8 Earthing Resistance (R_E function)

Earthing resistance is the sum of earth electrode dissipation resistance (R_D) and resistance of the earth conductor.

Earthing resistance is roughly calculated with an “earth electrode loop resistance measurement”. The resistance value R_{ELOOP} determined with this measuring method includes resistance values for functional earth R_F and phase L as well. These two values must be subtracted from the measured value in order to determine earthing resistance.

Assuming equal conductor cross-sections (phase L and neutral N), resistance at the phase conductor is half as great as line impedance Z_1 (phase + neutral).

According to DIN VDE 0100, functional earth R_F must lie within a range of 0Ω to 2Ω .

Earthing resistance is calculated with the following equation:

$$R_E = R_{ELOOP} - \frac{1}{2} \cdot R_L - R_B$$

When calculating earthing resistance, it is advisable to ignore the resistance value for functional earth R_F because this value is generally unknown.

The calculated resistance value thus includes the functional earth resistance value as a safety factor.

Line impedance Z_1 can only be measured with the 3-phase measuring adapter (accessory) in the Z_{Loop} mode.

Note

Interference voltages at the protective conductor PE or at the earth electrode have no influence on measuring results.

They can be measured by performing a voltage measurement with the test plug.

If dangerous contact voltage occurs during measurement ($> 50 \text{ V}$), the measurement is interrupted and safety shutdown ensues.

Connections

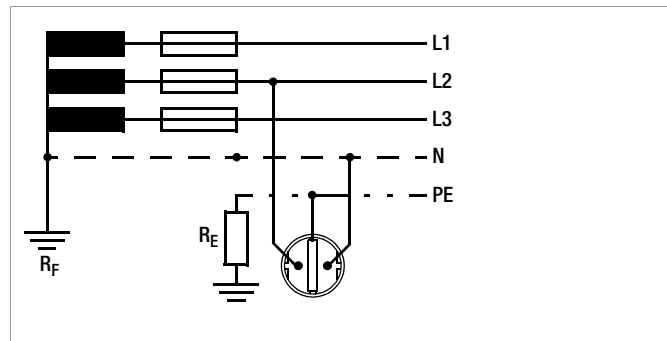

8.1 Performing Measurements

Automatic Measuring Range Selection

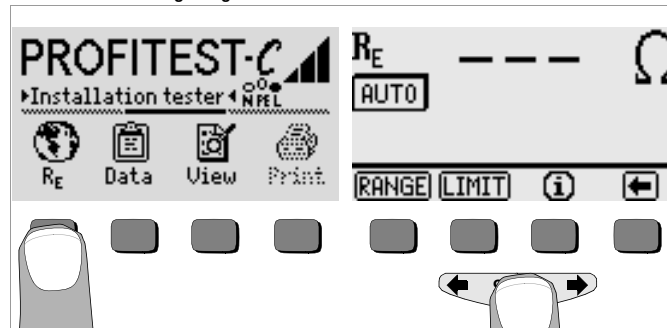

Manual Measuring Range Selection

Manual measuring range selection is provided in case earthing resistance needs to be measured in systems which are equipped with RCCBs. The instrument's test current I_T must be taken into consideration in order to prevent undesired tripping of the RCCB.

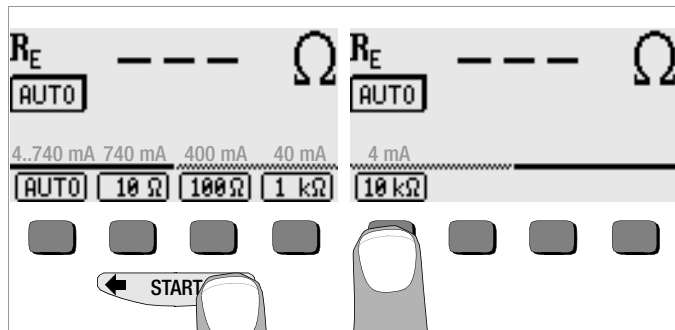

- ◇ Press the RANGE key.
- ◇ Select the measuring range with a test current which is less than the tripping current of the utilized RCCB.
- ◇ Start the measurement as described above.



Note

When manual range selection is used it must be observed that indicated accuracy values are only valid starting at 5% of the upper range limit value (except for 10 Ω range, separate entry for small values).

8.2 Setting Limit Values

A limit value can be selected for earthing resistance. If a measurement value exceeds this limit value, the U_L LED lights up.

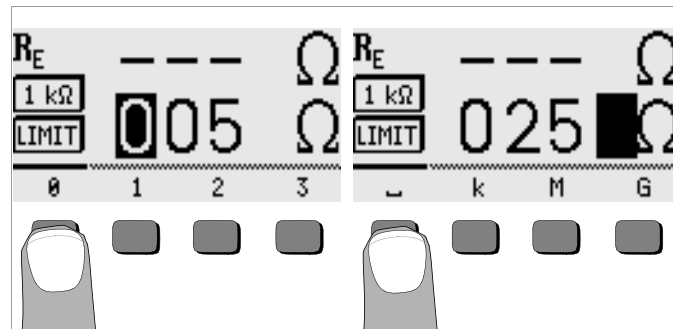

- ◇ Press the LIMIT key.
- ◇ First enter the numeral for the hundreds place. Display the desired numeral with the ← or the → key to this end. After a numeral has been selected, the cursor moves one place to the right. After the tens and the units have been entered, the cursor moves to position _ for ohms, or position k for kilo-ohms. The start menu appears after this last entry has been made.

8.3 Evaluating the Measurement Values

With the help of the on page 35, maximum resistance display values can be determined which may not be exceeded under consideration of the device's maximum measuring error in order to avoid exceeding the required earthing resistance. Intermediate values can be interpolated.



Note

Measurement Value Processing with PC Software (e.g. PS3)

Only one R_E measurement value is entered to some of the report forms. In order to assure that the PC software enters the desired value, enter the ! symbol as the first character in the comment line after the value has been saved to memory (see chapter 4.5), for example: !Foundation earth.

9 Characteristic Values

Function	Measured Quantity	Measuring Range (display range)	Resolution	Input Impedance / Test Current	Nominal Values	Intrinsic uncertainty	Nominal Range of Use	Measuring uncertainty	
U_{L-PE} U_{N-PE}	$\frac{U_{L-PE}}{U_{N-PE}} / \frac{U_{L-N}}{U_{N-PE}}$	0 ... 99.9 V 100 ... 300 V (0 ... 600 V)	0.1 V 1 V	500 k Ω	—	$\pm(2\%$ of rdg. + 2 d)	108 ... 253 V	$\pm(4\%$ rdg. + 3 d)	
		15.0 ... 99.9 Hz 100 ... 650 Hz	0.1 Hz 1 Hz	500 k Ω	—	$\pm(0.1\%$ of rdg. + 1 d)	15 ... 70 Hz	$\pm(0.2\%$ rdg. + 1 d)	
U_{3-}	U_{3-}	0 ... 99.9 V 100 ... 500 V (0 ... 600 V)	0.1 V 1 V	500 k Ω	—	$\pm(2\%$ of rdg. + 2 d)	108 ... 440 V	$\pm(4\%$ rdg. + 3 d)	
I_{Δ}	$U_{\Delta N}$	0 ... 99.9 V	0.1 V	$0.3 \cdot I_{\Delta N}$	$U_N = 120$ V $U_N = 230$ V $f_N = 50$ Hz $U_L = 25/50$ V $I_{\Delta N} = 10/30/100/300/500$ mA	$+(12.5\%$ of rdg. + 2 d) $+(2.5\%$ of rdg. – 2 d)	5 ... 70 V	+15% rdg. + 2 d	
	$R_E / I_{\Delta N} = 10$ mA	10 Ω ... 9.99 k Ω	10 Ω	$0.3 \dots 1.3 \cdot I_{\Delta N}$		—	Calculated Value	—	
	$R_E / I_{\Delta N} = 30$ mA	3 Ω ... 999 Ω 1 k Ω ... 6.40 k Ω	3 Ω 10 Ω						
	$R_E / I_{\Delta N} = 100$ mA	1 Ω ... 999 Ω	1 Ω						
	$R_E / I_{\Delta N} = 300$ mA	0.3 Ω ... 99.9 Ω 100 Ω ... 640 Ω	0.3 Ω 1 Ω						
	$R_E / I_{\Delta N} = 500$ mA	0.2 Ω ... 99.9 Ω 100 Ω ... 380 Ω	0.2 Ω 1 Ω						
	$I_{\Delta} / I_{\Delta N} = 10$ mA	3.0 ... 13.0 mA	0.1 mA						3.0 ... 13.0 mA
	$I_{\Delta} / I_{\Delta N} = 30$ mA	9.0 ... 39.0 mA							9.0 ... 39.0 mA
	$I_{\Delta} / I_{\Delta N} = 100$ mA	30 ... 130 mA	1 mA						30 ... 130 mA
	$I_{\Delta} / I_{\Delta N} = 300$ mA	90 ... 390 mA	1 mA						90 ... 390 mA
	$I_{\Delta} / I_{\Delta N} = 500$ mA	150 ... 650 mA	1 mA						150 ... 650 mA
	$U_{\Delta} / U_L = 25$ V	0 ... 25.0 V	0.1 V	same as I_{Δ}					
$U_{\Delta} / U_L = 50$ V	0 ... 50.0 V								
$t_T (I_{\Delta N}/5 \cdot I_{\Delta N})$	0 ... 99.9 ms 100 ... 999 ms	0.1 ms 1 ms	$1.05 \cdot I_{\Delta N} / 5 \cdot I_{\Delta N}$	± 3 ms	0 ... 1000 ms	± 4 ms			
Z_{Loop}	Z_{Loop} $Z_{Loop} 15$ mA	0 ... 0.49 Ω 0.5 ... 9.99 Ω 10.0 ... 30.0 Ω	10 m Ω 10 m Ω 100 m Ω	740 mA	$U_N = 120$ V $U_N = 230$ V	± 5 d $\pm(6\%$ of rdg. + 3 d) $\pm(6\%$ of rdg. + 3 d)	0.25 ... 0.49 Ω 0.50 ... 9.99 Ω 10.0 ... 30.0 Ω	$\pm(10\%$ of rdg. + 5 d) $\pm(10\%$ of rdg. + 5 d) $\pm(10\%$ of rdg. + 5 d)	
		0 ... 99.9 Ω 100 ... 250 Ω	100 m Ω 1 Ω	15 mA		$\pm(6\%$ of rdg. + 5 d) $\pm(6\%$ of rdg. + 3 d)	0.50 ... 99.9 Ω 100 ... 250 Ω	$\pm(15\%$ of rdg.+10 d) $\pm(10\%$ of rdg.+10 d)	
R_E	R_E	0 ... 0.49 Ω 0.5 ... 9.99 Ω 10.0 ... 99.9 Ω 100 ... 999 Ω 1.00 k ... 9.99 k Ω	10 m Ω 10 m Ω 10 m Ω 100 m Ω 1 Ω	740 mA 740 mA 400 mA 40 mA 4 mA	$f_N = 50$ Hz	± 5 d $\pm(6\%$ of rdg. + 3 d) $\pm(4\%$ of rdg. + 3 d) $\pm(4\%$ of rdg. + 3 d) $\pm(4\%$ of rdg. + 3 d)	0.25 Ω ... 0.49 Ω 0.50 Ω ... 9.99 Ω 10.0 Ω ... 99.9 Ω 100 Ω ... 999 Ω 1 k Ω ... 9.990 k Ω	$\pm(10\%$ of rdg. + 5 d) $\pm(10\%$ of rdg. + 5 d) $\pm(8\%$ of rdg. + 5 d) $\pm(8\%$ of rdg. + 5 d) $\pm(8\%$ of rdg. + 5 d)	

Reference Conditions

Line Voltage	230 V $\pm 0.1\%$
Line Frequency	50 Hz ± 0.2 Hz
Measured Quantity	
Waveshape	sine (deviation between RMS and rectified value < 1%)
Line Impedance Angle	$\cos \varphi = 1$
Power Supply	battery: 5.5 V $\pm 1\%$
Ambient Temperature	+23 °C ± 2 K
Relative Humidity	40% ... 60%
Finger Contact	potential difference to earth potential during testing

Nominal Ranges of Use

Voltage U_N	120 V (108 ... 170 V) 230 V (170 ... 253 V)
Frequency f_N	16 $\frac{2}{3}$ Hz (15.4 ... 18 Hz) 50 Hz (49.5 ... 50.5 Hz) 60 Hz (59.4 ... 60.6 Hz)
Overall Frequency Range	15 ... 70 Hz
Waveshape	sine
Temperature Range	0 °C ... + 40 °C
Battery Voltage	4.6 V ... 6.5 V
Line Impedance Angle	corresponds to $\cos \varphi = 1 \dots 0.95$

Ambient Conditions

Storage Temperature	-20 °C ... +60 °C (without batteries)
Operating Temperature	-10 °C ... +50 °C
Relative Humidity	max. 75%, no condensation allowed
Elevation	max. 2000 m
Deployment	indoors; outdoors only within the specified ambient conditions

Power Supply

Batteries	4 ea. 1.5 V baby cells (4 x C-Size) (alkaline-manganese per IEC LR14)
Rechargeable batteries	NiCd or NiMH
Battery Charger (not included)	NA 102 (article no. Z501N), 3.5 mm dia. jack plug
Charging Time	approx. 14 hours
Due to minimal charging capacity, fewer measurements can be performed with rechargeable batteries than with normal batteries as a rule.	

Electrical Safety

Safety Class	II per IEC 61010-1/EN 61010-1/ VDE 0411-1
Operating Voltage	300 V
Test Voltage	3.7 kV 50 Hz
Measuring Category	III
Fouling Factor	2
Electromagnetic Compatibility (EMC)	IEC 61326/EN 61326
Fuses at Terminals L and N	1 ea. type G fuse link F1H250V 5 mm x 20 mm (per IEC 127-2)

Overload Capacity

U_{L-PE} , U_{L-N} R_C , R_E , Z_{Loop}	600 V continuous 300 V (Limits the number of measurements and idle time. A thermostatic switch prevents execution of the function if overload occurs.)
Fine-Wire Fuse Protection	1 A 10 s, > 2 A — fuse blows

Data Interface

Type	infrared interface (SIR/IrDa) bidirectional, half-duplex
Format	9600 baud, 1 start bit, 1 stop bit, 8 data bits, no parity, no handshake
Range	max. 10 cm, recommended distance: < 4 cm

Mechanical Design

Display	multiple dot matrix display, 64 x 128 pixels, illuminated
Dimensions	275 mm x 140 mm x 65 mm (without meas. cables)
Weight	approx. 1.2 kg with batteries
Protection	housing: IP 52 per DIN VDE 0470 part 1/EN 60529 with pressure compensating diaphragm of microporous ePTFE, non-aging, dia. 8 mm in battery compartment cover

Extract from table on the meaning of IP codes

IP XY (1 st digit X)	Protection against foreign object entry	IP XY (2 nd digit Y)	Protection against the penetration of water
5	dust protected	2	vertically falling drops with enclosure tilted 15°

9.1 Lamp Functions

Lamp	Status	Measuring Function	Function
PE	lights up red	all	Device on and potential difference ≥ 150 V between finger contact and PE (protective contact), frequency: $f > 45$ Hz
Netz Mains	lights up green	$I_{\Delta} / R_E / Z_{Loop}$	3-pole connection: line voltage approx. 170 V to 253 V, measurement enabled
Netz Mains	blinks green	$I_{\Delta} / R_E / Z_{Loop}$	2-pole connection (e.g. N conductor not connected): line voltage approx. 170 V to 253 V, measurement enabled
Netz Mains	blinks red	$I_{\Delta} / R_E / Z_{Loop}$	Line voltage < approx. 170 V or > 253 V, measurement disabled
U_L	lights up red	I_{Δ}	– Contact voltage $U_{I\Delta N}$ or $U_{I\Delta} > 25$ V or > 50 V – Safety shutdown has occurred
		R_E	– Limit value for R_E exceeded
RCD/FI	lights up red	I_{Δ}	The RCCB was not tripped, or was tripped too late during the trip test

The Netz/Mains lamp is not activated for measurement of U_{L-PE} .

10 List of Abbreviations and their Meanings

RCCBs

I_{Δ}	Tripping current
$I_{\Delta N}$	Nominal residual current
I_F	Rising test current (fault current)
PRCD	Portable RCD
R_E	Calculated earthing resistance or earth electrode loop resistance
S	Selective RCCB
SRDC	Socket RCD (permanently installed)
t_T	Time to trip
$U_{I\Delta}$	Contact voltage at the moment of tripping
$U_{I\Delta N}$	Contact voltage related to nominal residual current $I_{\Delta N}$
U_L	Contact voltage limit value

Overcurrent Protective Devices

I_{sc}	Calculated short-circuit current (at nominal voltage)
Z_{Loop}	Loop impedance

Earthing

R_F	Functional earthing resistance
R_E	Measured earthing resistance
R_{ELoop}	Earth electrode loop resistance

Current

I_M	Measuring current
I_N	Nominal current
I_T	Test current

Voltage

f	Line voltage frequency
f_N	Nominal frequency for nominal voltage
U_E	Earth electrode voltage
U_{L-L}	Voltage between two phases
U_{L-N}	Voltage between L and N
U_{L-PE}	Voltage between L and PE
U_N	Nominal line voltage
U_{3-}	Highest voltage measured while determining phase sequence

11 Appendix

Tables for determining maximum and minimum display values under consideration of the device's maximum measuring error.
These tables do not apply for the measurement with 15 mA test current!

11.1 Table of Loop Impedance Values

$Z_{\text{Loop}} \Omega$	
Limit Value	Max. Display Value
0.25	0.15
0.30	0.19
0.35	0.23
0.40	0.28
0.45	0.32
0.50	0.37
0.60	0.45
0.70	0.59
0.80	0.68
0.90	0.77
1.00	0.86
1.50	1.32
2.00	1.77
2.50	2.23
3.00	2.68
3.50	3.14
4.00	3.59
4.50	4.05
5.00	4.50
6.00	5.41
7.00	6.32
8.00	7.23
9.00	8.14
10.00	8.64
15.00	13.2
20.00	17.7
25.00	22.3
30.00	26.8

11.2 Table of Earthing Resistance Values

$R_E \Omega$					
Limit Value	Max. Display Value	Limit Value	Max. Display Value	Limit Value	Max. Display Value
0.25	0.15	10.0	9.05	1.00 k	921
0.30	0.19	15.0	13.4	1.50 k	1.34 k
0.35	0.23	20.0	18.1	2.00 k	1.81 k
0.40	0.28	25.0	22.7	2.50 k	2.27 k
0.45	0.32	30.0	27.3	3.00 k	2.73 k
0.50	0.37	35.0	31.9	3.50 k	3.19 k
0.60	0.45	40.0	36.6	4.00 k	3.66 k
0.70	0.59	45.0	41.2	4.50 k	4.12 k
0.80	0.68	50.0	45.8	5.00 k	4.58 k
0.90	0.77	60.0	55.1	6.00 k	5.51 k
1.00	0.86	70.0	64.4	7.00 k	6.44 k
1.50	1.32	80.0	73.6	8.00 k	7.36 k
2.00	1.77	90.0	82.9	9.00 k	8.29 k
2.50	2.23	100	92.1	9.99 k	9.20 k
3.00	2.68	150	134		
3.50	3.14	200	181		
4.00	3.59	250	227		
4.50	4.05	300	273		
5.00	4.50	350	319		
6.00	5.41	400	366		
7.00	6.32	450	412		
8.00	7.23	500	458		
9.00	8.14	600	551		
10.00	9.05	700	644		
		800	736		
		900	829		
		999	920		

11.3 Table of Minimum Display Values for Short-Circuit Current for the Determination of Current Ratings for Various Fuses and Circuit Breakers for Systems with a Nominal Voltage of $U_N=230/400\text{ V}$

Nominal Current I_N [A]	Low-Voltage Fuses in Accordance with the DIN VDE 0636 Series of Standards				with Circuit Breakers							
	Characteristic gL		Characteristic gL		Characteristic B (previously L)		Characteristic C (previously G, U)		Characteristic D		Characteristic K	
	Breaking Current, 5 s		Breaking Current, 0.2 s		Breaking Current, $5 \times I_N (< 0.2\text{ s} / 0.4\text{ s})$		Breaking Current, $10 \times I_N (< 0.2\text{ s} / 0.4\text{ s})$		Breaking Current, $20 \times I_N (< 0.2\text{ s} / 0.4\text{ s})$		Breaking Current, $14 \times I_N (< 0.1\text{ s})$	
	Limit Value [A]	Min. Display [A]	Limit Value [A]	Min. Display [A]	Limit Value [A]	Min. Display [A]	Limit Value [A]	Min. Display [A]	Limit Value [A]	Min. Display [A]	Limit Value [A]	Min. Display [A]
2	9.21	10	20	22	10	11	20	22	40	44	28	31
3	14.1	15	30	33	15	16	30	33	60	67	42	47
4	19.2	21	40	44	20	22	40	44	80	90	56	62
6	28	31	60	67	30	33	60	67	120	136	84	94
8	37.5	42	80	90	40	44	80	90	160	183	112	127
10	47	52	100	113	50	56	100	113	200	231	140	159
13	60	67	125	142	65	73	130	148	260	305	182	209
16	72	81	148	169	80	90	160	183	320	381	224	260
20	88	99	191	220	100	113	200	231	400	487	280	330
25	120	136	270	317	125	142	250	292	500	719	350	420
32	156	178	332	397	160	183	320	381	640	989	448	552
40	200	231	410	500	200	231	400	487	800	1.35 k	560	830
50	260	305	578	865	250	292	500	625	1000	1.92 k	700	1118
63	351	421	750	1.23 k	315	375	630	969	1260	2.92 k	882	1.57 k
80	452	557										
100	573	855										
125	751	1.23 k										
160	995	1.90 k										

Example

Display value 90.4 A → next smallest value for characteristic B circuit breaker from table: 85 A → rated current (I_N) for the protective device is max. 16 A.

12 Maintenance

12.1 Self-Test

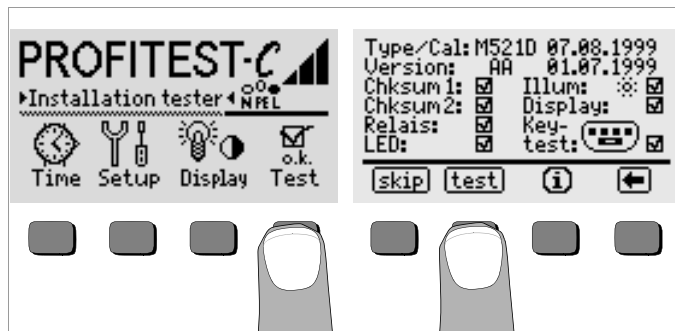

- ◇ The self-test is started from the main menu with the Test key. The test has a duration of several minutes.

The following information is displayed in the two headers:

Type/Cal: Device type / date of last calibration

Version: Software version and issue date

Self-tests for items Chksum through LED are performed automatically, one after the other, and are checked off or marked with a horizontal dash if they are not passed.

Chksum1/2: Status display for internal testing (Each test must be completed with a check mark. If not, the measuring and test instrument may no longer be used. Please contact our service center in this case.

Relays: Each relay is switched twice.

LEDs: The U and RCD/FI lamps each blink twice in red, and the Netz/Mains lamps blinks twice in green and twice in red. The PE lamp cannot be tested automatically!

As soon as the tests in the left-hand column have been completed, the following tests must be started manually.

- ◇ **Illum:** Press the Test key twice in order to activate and deactivate display illumination.
- ◇ **Display:** Press the Test key after each test pattern has been displayed in order to test the display elements.
- ◇ **Keytest:** Perform the key test by pressing each of the softkeys once, and by pressing the start key once in each of its three positions. The keys appear filled in at the key pictograph after they have been tested.

Individual tests can be skipped by pressing the Skip key before starting the respective test. These tests are then identified with a horizontal dash, as is also the case for tests which have not been passed.

12.2 Battery Operation

When only one solid segment remains in the battery symbol, the batteries must be replaced, or recharged if rechargeable batteries are used.

Check the batteries at short, regular intervals or after lengthy periods of storage to make sure no leakage has occurred. If leakage has occurred, the electrolyte must be carefully and completely removed from the instrument with a damp cloth before new batteries are installed.

Charging the Batteries



Attention!

Use only the NA102 battery charger (article no. Z501N) with safe electrical isolation and a nominal secondary voltage of 9 V DC to recharge the batteries.

Before connecting the battery charger to the charging socket at the device, make sure of the following points:

- **Rechargeable batteries have been installed (not normal batteries).**
- The instrument has been disconnected from the measuring circuit at all poles.
- The voltage selector at the charger has been set to 9 V.

Connect the NA 102 battery charger to the charging socket with the 3.5 mm jack plug. Set the voltage selector switch at the NA 102 to 9 V. Switch the test instrument on.

The test instrument recognizes the fact that a battery charger has been connected and starts the charging cycle. The 5 segments of the battery symbol are continuously displayed in a sweeping pattern from left to right for the entire duration of the charging cycle.

Depleted batteries require a charging cycle of approximately 14 hours. If the batteries are exhausted to a great enough extent, the test instrument can no longer be switched on. If this is the case, leave the test instrument connected to the activated battery charger for about 30 minutes, and then proceed as described above.

12.3 Fuses

If a fuse has blown due to an overload, an appropriate error message appears at the LCD. However, the instrument's voltage measuring ranges are still functional.

Replacing Fuses

The fuses can be accessed easily from the outside of the instrument, and are located to the left of the mains connector cable.

- ⇨ Remove the cap for the respective fuse with the help of a suitable tool (e.g. screwdriver) by pressing and turning counterclockwise.



Attention!

Incorrect fuses may cause severe damage to the test instrument.

Only original fuses from GMC-I Messtechnik GmbH assure the required protection by means of suitable breaking characteristics (article no. 3-578-164-01).

Bridging or repairing fuses is prohibited!

The instrument may be damaged if fuses with other current ratings, blowing or breaking characteristics are used!

-
- ⇨ Remove the defective fuse and replace it with a new replacement fuse. Replacement fuses are located in the battery compartment.
 - ⇨ Insert the new fuse and the cap together, and lock into place by turning clockwise.
 - ⇨ Replace the battery compartment cover and secure it with the screws.

12.4 Housing

No special maintenance is required for the housing. Keep outside surfaces clean. Use a slightly dampened cloth and/or a special purifier for synthetic material for cleaning. Avoid the use of cleansers, abrasives and solvents.



Attention!

For the following reasons, the housing may not be opened by the operator:

- Unexpected problems may occur during reassembly.
- Sealing requirements are no longer fulfilled.

Device Return and Environmentally Compatible Disposal

The instrument is a category 9 product (monitoring and control instrument) in accordance with ElektroG (German Electrical and Electronic Device Law). This device is not subject to the RoHS directive.

We identify our electrical and electronic devices (as of August 2005) in accordance with WEEE 2002/96/EG and ElektroG with the symbol shown to the right per DIN EN 50419.



These devices may not be disposed of with the trash. Please contact our service department regarding the return of old devices (see chapter 13).

13 Repair and Replacement Parts Service, Calibration Center * and Rental Instrument Service

When you need service, please contact:

GMC-I Service GmbH

Service Center

Thomas-Mann-Str. 16-20

90471 Nürnberg • Germany

Phone: +49 911 817718-0

Fax: +49 911 817718-253

E-mail: service@gossenmetrawatt.com

This address is only valid in Germany.

Please contact our representatives or subsidiaries for service in other countries

* **DKD** Calibration Laboratory for Electrical Quantities DKD–K–19701 accredited per DIN EN ISO/IEC 17025:2005

Accredited measured quantities: direct voltage, direct current values, DC resistance, alternating voltage, alternating current values, AC active power, AC apparent power, DC power, capacitance, frequency and temperature

Competent Partner

GMC-I Messtechnik GmbH is certified in accordance with DIN EN ISO 9001:2000.

Our DKD calibration laboratory is accredited by the Deutscher Kalibrierdienst (*German Calibration Service*) in accordance with DIN EN ISO/IEC 17025:2005 under registration number DKD–K–19701.

We offer a complete range of expertise in the field of metrology: from **test reports** and **proprietary calibration certificates** right on up to **DKD calibration certificates**.

Our spectrum of offerings is rounded out with free **test equipment management**.

An **on-site DKD calibration station** is an integral part of our service department. If errors are discovered during calibration, our specialized personnel

are capable of completing repairs using original replacement parts. As a full service calibration laboratory, we can calibrate instruments from other manufacturers as well.

14 Product Support

If required please contact:

GMC-I Messtechnik GmbH

Product Support Hotline

Phone: +49 911 8602-0

Fax: +49 911 8602-709

E-mail: support@gossenmetrawatt.com

Edited in Germany • Subject to change without notice • A pdf version is available on the internet

 **GOSSEN METRAWATT**
GMC-I Messtechnik GmbH
Südwestpark 15
90449 Nürnberg • Germany

Phone +49 911 8602-111
Fax +49 911 8602-777
E-Mail info@gossenmetrawatt.com
www.gossenmetrawatt.com