

## Features

- Double Shut Off
- Ball Lock
- Operating Temperature from -25 °C to +125 °C
- ISO 7241-1 Serie B
- Stainless Steel 316
- Interchangeable:

Hansen HK Series  
Parker 60 Series  
Rectus 71-72-73-74-75-76 Series  
Faster HNV Serie  
ISO 7241-1 Serie B

## RS PRO Hydraulic Quick Connect Couplings

RS Stock No.: 0727355



RS PRO is the own brand of RS. The RS PRO Seal of Approval is your assurance of professional quality, a guarantee that every part is rigorously tested, inspected, and audited against demanding standards. Making RS PRO the Smart Choice for our customers.

## Product Description

Functions: If socket and plug valves seal instantly, automatically shutting off fluid flow to prevent leakage. If the socket and plug valves pushed together, opening to permit free flow to of fluid through coupler. O-Ring in the socket seals the plug surface preventing any leakage.

Applications:

- High pressure hydraulic circuits
- Connection of hydraulic pumps, valves, and quick tools change
- Aluminium die casting
- Test Benches
- Plastic industry tool changing
- Steel Industry

Attention: Only plug and socket with the same thread fit together

Interchangeability:

- Hansen HK Series
- Parker 60 Series
- Rectus 71-72-73-74-75-76 Series
- Faster HNV Serie
- ISO 7241-1 Serie B

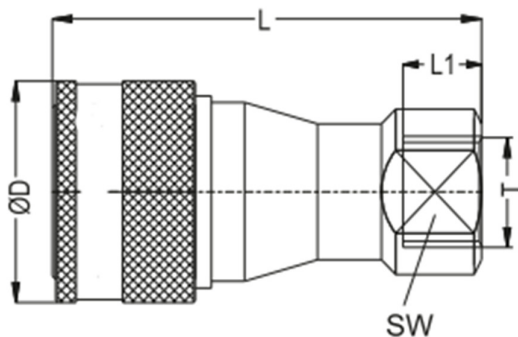

Female Thread Coupler  
  
 Double Shut-off

T Connection	SW (mm)	ØD (mm)	L (mm)
G 1/8"	14	24	48.7

## Specifications

<b>Manufacturer Series</b>	70
<b>Standards Met</b>	ISO 7241 Serie B
<b>Compatible with</b>	Hansen HK Series Parker 60 Series Rectus 71-72-73-74-75-76 Series Faster HNV Serie
<b>Maximum Operating Pressure</b>	350 Bar
<b>Minimum Operating Temperature</b>	-25 °C
<b>Maximum Operating Temperature</b>	+125 °C
<b>Type</b>	Quick Connect Coupling
<b>Locking Style</b>	Ball Lock
<b>Double Shut Off</b>	Double Shut Off
<b>Thread Size</b>	1/8 in
<b>Thread Standard</b>	G
<b>Thread Gender</b>	Female
<b>Coupling Gender</b>	Female
<b>Thread</b>	G 1/8 in Female
<b>Material</b>	Stainless Steel 316
<b>Finish</b>	AISI 316
<b>Seal Material</b>	Nitrile Rubber
<b>Sleeve Material</b>	AISI-316
<b>Valve Material</b>	AISI-316
<b>Spring Material</b>	14310
<b>Locking O Ring Material</b>	Nitrile Rubber
<b>Ball Material</b>	AISI-316

