

Subminiatur Rundsteckverbinder Serie 711

Subminiature Round Connectors Series 711

Technische Daten		Specifications							
Polzahl	Number of contacts	2	3	4	5		7	8	
Verriegelung	Connection	schrauben/screw connection							
Anschlußart	Termination	löten/tauchlöten / soldering / dip soldering							
Anschlußquerschn. max. mm ²	Max. wire gauge in mm ²	0,25	0,25	0,25	0,25		0,14	0,14	
Kabeldurchlaß max. mm	Max. cable outlet in mm	4	4	4	4		4	4	
Kontaktoberfläche	Finish of contacts	Ni + 0,8 µm Au							
Werkstoff Federkontakt	Material socket contact	Cu Sn							
Werkstoff Messerkontakt	Material male contact	Cu Zn							
Formstoff Kontaktträger	Dielectric of insert	PETP gv							
Formstoff Gehäuse	Dielectric of housing	Messing vernickelt, Trägerhülse PBTB gv / Brass nickel plated, carrier sleeve PBTB gv							
Gehäuse Schutzart n. DIN VDE 0470 in gestecktem Zustand	Shell protection standard DIN VDE 0470 only when mated	IP 40							
Mechanische Lebensdauer nach IEC 512, Teil 6	Mating cycles according to IEC 512, part 6	≥ 500							
Steckkraft ca.	Insertion force approx.	2 N	3 N	4 N	5 N		7 N	8 N	
Ziehkraft ca.	Withdrawal force approx.	2 N	3 N	4 N	5 N		7 N	8 N	
Betriebstemperatur	Operating temperature	- 40°C / + 85°C							
Nennstrom je Kontakt	Rated current per contact	3 A	3 A	3 A	3 A		1 A	1 A	
Nennspannung nach VDE 0110/72 Gruppe A	Rated voltage according to VDE standard 0110/72 gr. A	60 V ~							
Prüfspannung VDE 0627	Test voltage VDE 0627	500 V ~							
Durchgangswiderstand nach IEC 512, Teil 2	Volume resistance according to IEC 512, part 2	≤ 3 mΩ	≤ 3 mΩ	≤ 3 mΩ	≤ 3 mΩ		≤ 5 mΩ	≤ 5 mΩ	
Isolationswiderstand nach IEC 512, Teil 2	Insulation resistance according to IEC 512, part 2	> 10 ¹⁰ Ω							
Betriebskapazität zwischen zwei Kontakten ca.	Capacity between two contacts approx.	0,5 pF							
Zugentlastung	Cable clamp	50 N (4 mm Kabel/cable)							
Gewicht ca.	Weight approx.	4 g							

Konstruktionsänderungen aus Gründen der Qualitätsverbesserung oder einer erweiterten Anwendungsmöglichkeit sowie aus Fertigungsgründen müssen wir uns vorbehalten. Zu Ersatzlieferungen älterer Ausführungen sind wir dabei nicht verpflichtet.

We reserve the right to modify designs in the course of improvements of the quality of our products or extending their field of application or to facilitate production, without prior notification. This does not commit us to replace earlier versions.

Subminiatur Rundsteckverbinder Serie 711

Subminiature Round Connectors Series 711

Polbilder/Ansicht auf Lötanschlußseite der Steckereinsätze /
Contact configuration / View on solder termination side of male inserts

Montageausschnitt
Mounting detail

2 pol.

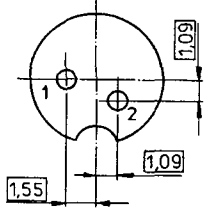

3 pol.

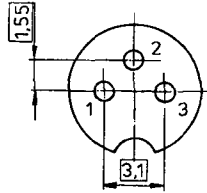

4 pol.

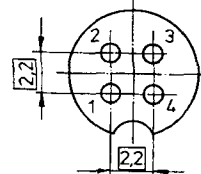

5 pol.

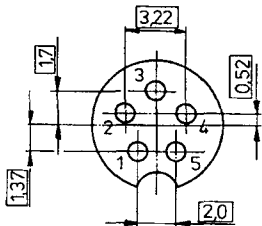

7 pol.

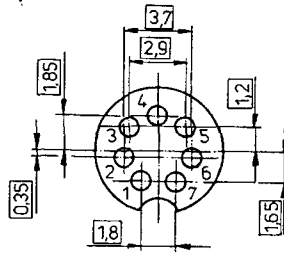

8 pol.

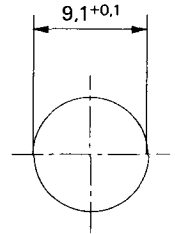
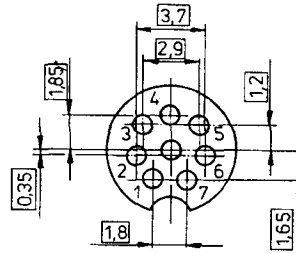

Strombelastbarkeitskurve (nach DIN 41640 T3) /
Derating diagram (in accordance with DIN 41640 T3)

Belastungsstrom I (A) / Load current I (A)

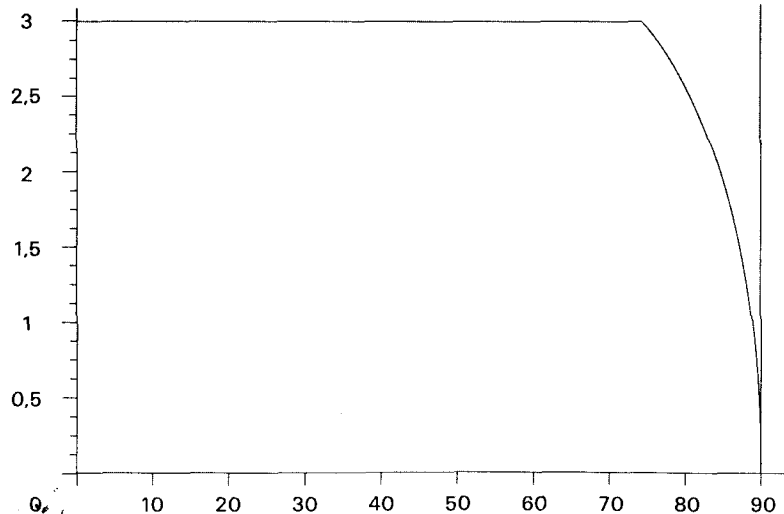

Bauelemente Umgebungstemperatur T_U (Grad °C) / Devices ambient temperature (Degree)

Subminiatur Rundsteckverbinder Serie 711

Subminiature Round Connectors Series 711

Montageanleitung
Handling instruction

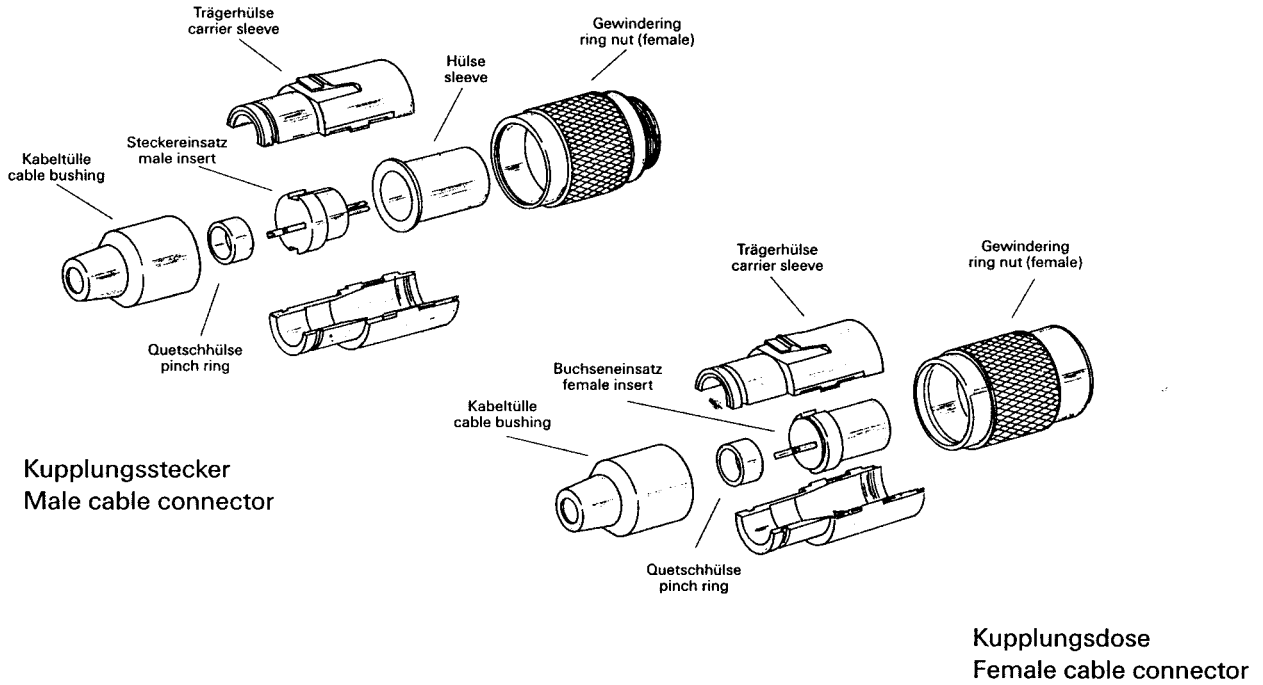

Zubehör
Accessories mm (inch)

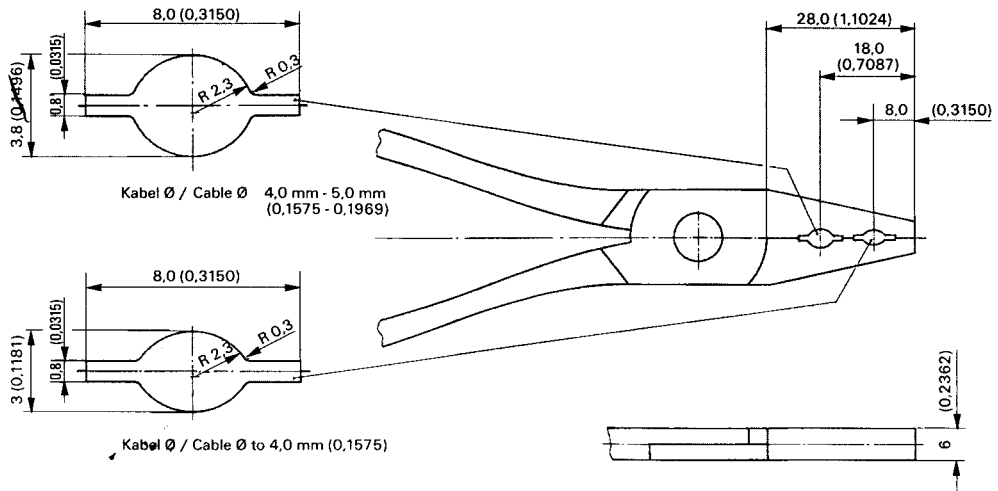

Quetschzange für Kabel Ø / pinch tool for cable Ø
4,0 mm (0,1575); 5,0 mm (0,1969) DIN 5258

Bestell - Nummer / Ordering number
07 - 0049 - 01

Subminiatur Rundsteckverbinder Serie 711

Subminiature Round Connectors Series 711

Abbildung
Figure

Maßzeichnung
Drawing mm (inch)

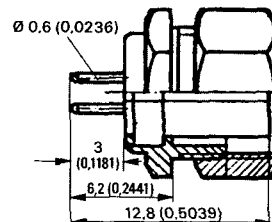
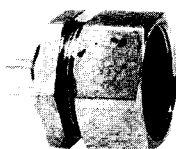
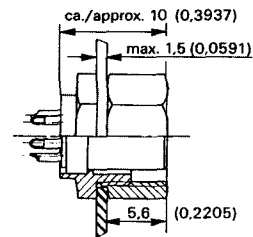
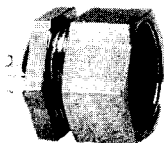
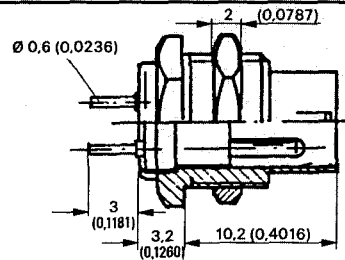
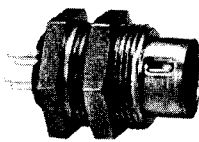
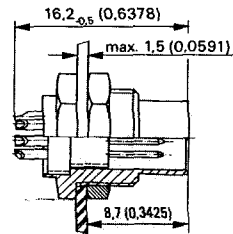
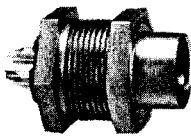
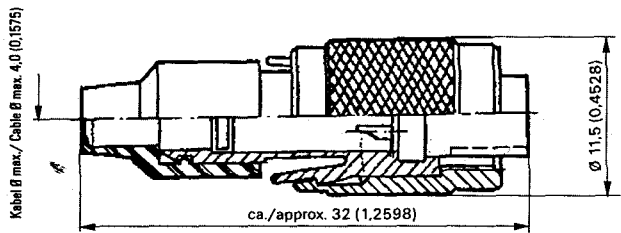
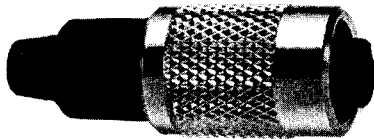
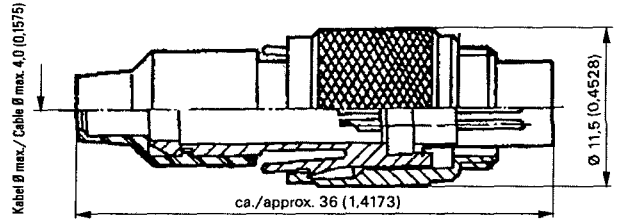
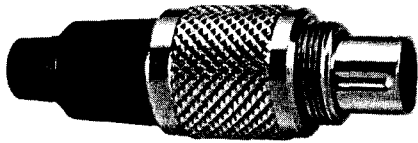

Subminiatur Rundsteckverbinder Serie 711

Subminiature Round Connectors Series 711

Bezeichnung Designation	Polzahl No. of cont.	Bestell - Nummer / Ordering number	
		Standard / standard	Kabeldurchlaß/Cable outlet 5 mm (0,1969)
Kupplungsstecker Male cable connector	2		
	3	RS 115-2679	
	4	RS 115-2348	
	5	RS 115-2685	
	7	RS 115-2708	
	8		
Kupplungsdose Female cable connector	2		
	3	RS 115-2871	
	4	RS 115-2354	
	5	RS 115-2887	
	7	RS 115-2893	
	8		
Flanschstecker, löten Male socket, soldering	2		—
	3	RS 115-2900	—
	4	RS 115-2360	—
	5	RS 115-2916	—
	7	RS 115-2922	—
	8		—
Flanschstecker tauchlöten/Frontmontage Male socket dip soldering / front screwed	2		—
	3		—
	4		—
	5		—
	7		—
	8		—
Flanschdose, löten Female socket, soldering	2		—
	3	RS 115-2714	—
	4	RS 115-2376	—
	5	RS 115-2720	—
	7	RS 115-2736	—
	8		—
Flanschdose tauchlöten/Frontmontage Female socket dip soldering / front screwed	2		—
	3		—
	4		—
	5		—
	7		—
	8		—