

NEVO+600S-1-1-1-1

- Pre-Configured Nevo
- V Range (1.5V to 7.5V)
- Industrial Approvals



600 watt in the palm of your hand

The NEVO+600S-1-1-1-1 is a pre-configured modular power supply which delivers a full 600 watts without de-rating for line voltages $\geq 120V_{ac}$ making it the ultimate power solution for products destined for the global market. Through the implementation of a fan control circuit the NEVO+ also features reduced fan noise. The NEVO+ delivers up to 600 watts from a 600 gram 5" x 3" x 1U package and consists of an input module together with four isolated output modules. The series carry full UL60950 safety approvals and comply with EN61000-3, EN61000-4 and EN55022-B EMC standards.

MAIN FEATURES:

- ✓ No Line de-rating $\geq 120V_{AC}$
- ✓ Reduced fan noise
- ✓ 600 watt output
- ✓ 5" x 3" x 1U footprint
- ✓ Adjustable output voltage
- ✓ High reliability
- ✓ High efficiency – up to 89%
- ✓ Only 0.6kg – 100W/kg
- ✓ High power density (25W/in³)
- ✓ Remote current/voltage programming
- ✓ Current output signal
- ✓ Accurate current sharing
- ✓ 5V 200mA bias supply
- ✓ RoHS compliant
- ✓ Field configurable
- ✓ Two year warranty

SYSTEM SPECIFICATIONS

INPUT ELECTRICAL						
Parameter	Details	Min	Typ	Max	Units	
AC Input Voltage	Nominal range is 100Vrms to 240Vrms	85		264	Vrms	
AC Input Frequency	Contact factory for 400Hz operation	47	50/60	63	Hz	
DC Input Voltage		120		300	Vdc	
Power Rating	See graphs for deratings			600	Watts	
Input Current	600 Watts output at 180Vrms input			6	A	
Inrush Current	265Vrms (cold start)			20	A	
Fusing	5 x 20 Fast acting			8	A	
Input Current Limit	Maintains power factor		8		A	
Efficiency	See graphs		86	89	%	
Idle Power	All outputs fitted and enabled		28		Watts	
Idle Power	All outputs fitted and disabled		21		Watts	
Power Factor	Typical value for 300 Watts output at 240Vrms input		0.96	0.99		
Holdup	600 Watts output at 180Vrms input	17	20	21	mS	
UVLO	Turn on only	78		84	Vrms	
Over Temperature	Internally monitored, Latching	115		125	°C	
Reliability	40°C 80% load			2	FPMH	
SIGNALS	Bias Voltage	4.8	5	5.2	V	
	Bias Current	0		200	mA	
	Power Good Voltage	PNP open collector with internal 10k pull down resistor	8	10	15	V
	Power Good Current		0		20	mA
	Inhibit Voltage		2		15	V
	Inhibit Current	10k ohm input impedance	0.2		1.5	mA
	Global Inhibit Voltage		3		15	V
	Global Inhibit Current	5k ohm input impedance	0.6		3	mA
	AC_OK Voltage		1		4	V
	AC_OK Current		-10		20	mA
AC_OK Warning		5			mS	

SYSTEM OUTPUT ELECTRICAL				
Maximum System Current	Achieved when all four outputs are connected in parallel		100	A
Maximum System Voltage	Achieved when all four outputs are connected in series		30	V

NOTES:
 1. Refer to the user manual when connecting units in series and/or in parallel.
 2. All specifications are believed to be correct at time of publication and are subject to change without notice.

INDIVIDUAL OUTPUT ELECTRICAL					
Parameter	Details	Min	Typ	Max	Units
Output Voltage Range	See table for limits	1.5	5	7.5	V
Rated Current				25	A
Average Output Power				125	Watts
Peak Output Power	See graph, < 5 seconds 50% duty cycle			187.5	Watts
Initial Voltage Accuracy	Factory set units	-0.5		0.5	%
Manual Voltage Adjust	11 turn potentiometer		0.545		V/turn
Load Regulation	Measured at sense terminals	-50		50	mV
Line Regulation	Measured at sense terminals	-0.1		0.1	%Vnom
Cross Regulation	Measured at sense terminals	-0.2		0.2	%Vnom
Minimum Load				0	Watts
Temperature Coefficient		-0.02		0.02	%/°C
Ripple and Noise	20MHz BW, pk-pk			1	%Vnom
Transient Response	25% to 75% load transient at 0.5A/uS Recovery to within 10% of Vset			1	V
Turn On Rise Time	Monotonic 10% to 90%	1.5		3.5	mS
Turn On Overshoot				0.1	%Vset
Turn On Delay	AC to PG EN to PG		600 15	750 20	mS
Current Share Accuracy				5	%Imax
Open Sense Offset	Open sense, voltage offset due to bias currents			2	%Vnom
Holdup Voltage				6	V
Isolation to Ground	Each terminal			250	V
Over Current Protection	% of rated current	105		125	%Irated
Reverse Current Protection	% of rated current	-6		0	%Irated
Short Circuit Protection (Hiccup Mode)	Period		125		mS
	Duty cycle		3		%
	Voltage threshold (Measured at sense terminals)		1		V
Over Voltage Protection	Latching		9.5		V
Over Temperature Protection	Internally monitored, Latching	115		125	°C
Sense Cable Protection	Positive	-1		2	V
	Negative			1	V
Power Good Threshold	Low threshold only		90		%Vset
Current Output Signal	$I_{SIG} = 0.6 + I_{OUT} / (I_{RATED} * 1.25)$	0		110	%Irated
Current Limit Control	$I_{LMT} = (V_{CTRL} - 0.6) * I_{RATED} * 1.25$	0		110	%Irated
Remote Voltage Control	$V_{OUT} = V_{SET} * ((1.8 - V_{CTRL}) / 0.6)$	0		300	%Vset
Bias Supply	10mA max	4.5	5	5.2	V
Reliability	40°C 80% load			1	FPMH
Warranty				2	Years
Wire Size		12	10		AWG
Weight			60		Grams
Size	60mm x 35mm x 17mm				

INSTALLATION			
Parameter	Details	Parameter	Details
Equipment Class	I	Flammability Rating	94V-2
Installation Category	II	IP Rating	IP10
Pollution Degree	2	RoHS Compliance	2002/95/EC
Material Group	IIb (Indoor use only)		

RELIABILITY				
Component	Details	Min	Max	Units
Fan	Mag Lev Std		2.7	FPMH
Input	Excluding Fan		2	FPMH
Output	See individual output datasheets		1	FPMH
Warranty			2	Years

SAFETY				
Parameter	Details	Min	Max	Units
Isolation Voltage	Input to Output		4000	Vac
	Input to Chassis		1500	Vac
	Output to Chassis		250	Vdc
	Output to Output		250	Vdc
Isolation Clearance	Primary to Secondary (Reinforced)	7		mm
	Primary to Chassis (Basic)	2.5		mm
Isolation Creepage	Primary to Secondary (Reinforced)	12		mm
	Primary to Chassis (Basic)	4		mm
Leakage Current	265Vac, 63Hz, 25°C		1500	uA

ENVIRONMENTAL					
	Parameter	Details	Min	Max	Units
Storage	Temperature		-40	+85	°C
	Humidity	Relative, non-condensing	5	95	%
	Altitude		-200	5000	m
	Air Pressure		54	106	kPa
Operation	Temperature	Full Power Derate input and output at 2.5% / °C	-20 50	50 70	°C °C
	Humidity	Relative, non-condensing	5	95	%
	Altitude	(-200 to 2000m for UL60601-1)	-200	3000	m
	Noise Level	Measured 1m from fan intake		45	dBa
	Shock	3000 bumps at 10G (16mS) half sine wave			
Vibration	1.5G 10 to 200Hz sine wave, 20G for 15min in 3 axes random vibration				

EMC			
	Parameter	Standard	Level
Emissions	Radiated Electric Field	EN55011, EN55022, FCC	B
	Conducted Emissions	EN55011, EN55022, FCC	B
	Harmonic Distortion	EN61000-3-2	Compliant
	Flicker & Fluctuation	EN61000-3-3	Compliant
Immunity	Electrostatic Discharge	EN61000-4-2 (15kV air, 8kV contact)	4
	Radiated RFI	EN61000-4-3 (10 V/m)	3
	Fast Transient Burst	EN61000-4-4 (4kV)	4
	Input Line Surges	EN61000-4-5 (1kV L-N, 2kV L-E)	3
	Conducted RFI	EN61000-4-6 (10V)	4
	Power Freq. Magnetic Field	EN61000-4-8 (10A/m)	3
	Voltage Dips	EN61000-4-11 (EN55024)	Compliant

MECHANICAL	
Parameter	Details
Size	77.7mm x 133.7mm x 41mm (all external dimensions ± 1.0mm)
Weight	360 gram + 60 gram per output module
Mounting	Bottom or Side mounting (See diagram for details)

AGENCY APPROVALS			
Standard	Details	Standard	Details
IEC/EN60950-1			
UL60950-1			
CSA-C22.2 No. 60950-1-03			
CE MARK	LVD 73/23/EEC	UL file number	UL: E316486
CB certificate and report available on request			

INPUT ELECTRICAL GRAPHS

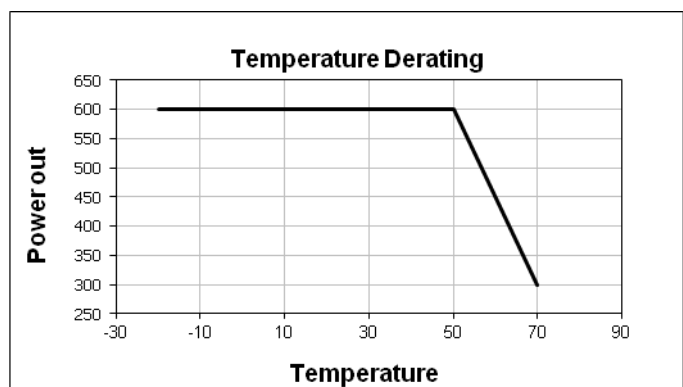
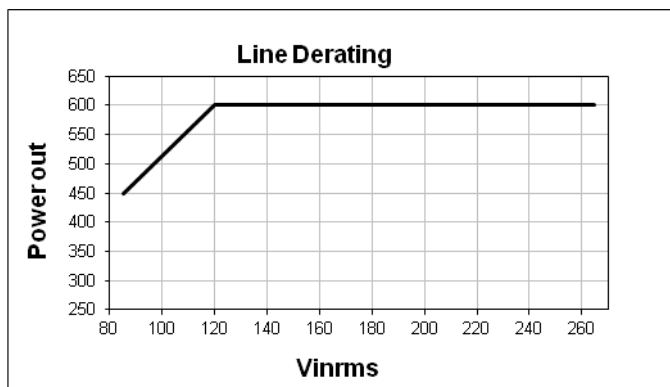

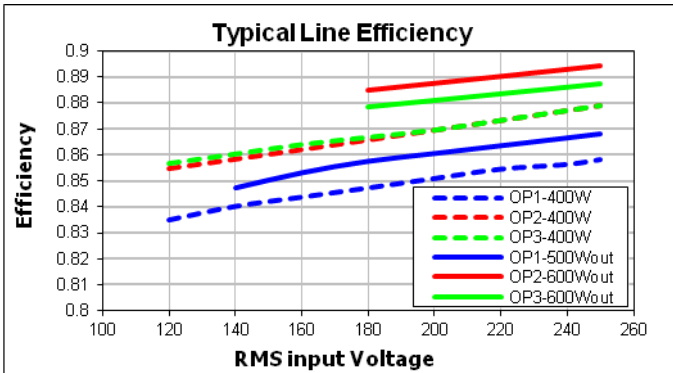
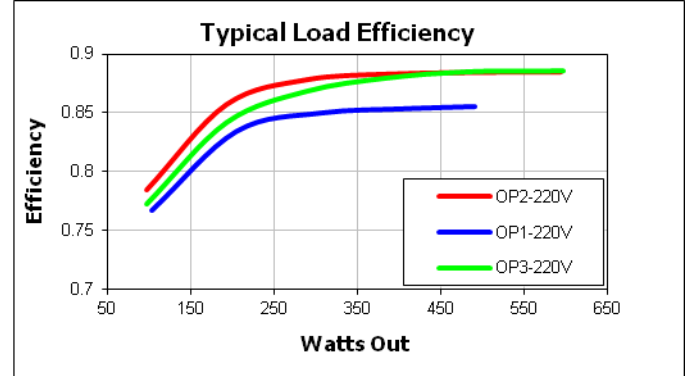
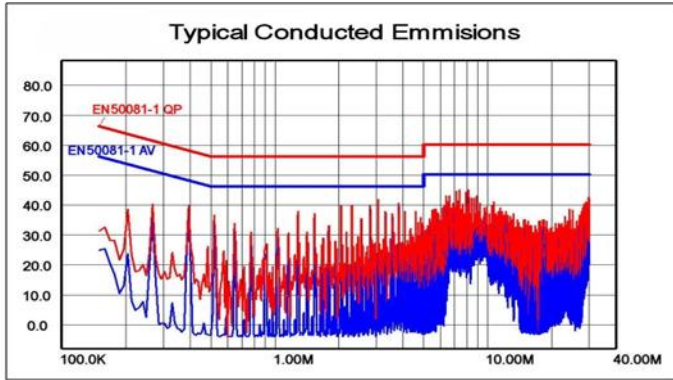

OUTPUT ELECTRICAL GRAPHS

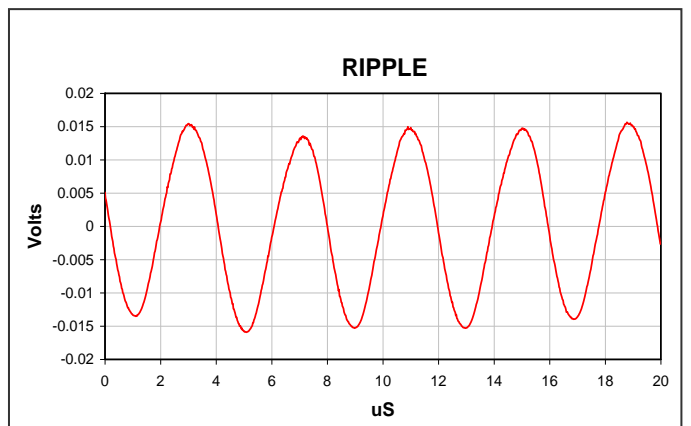
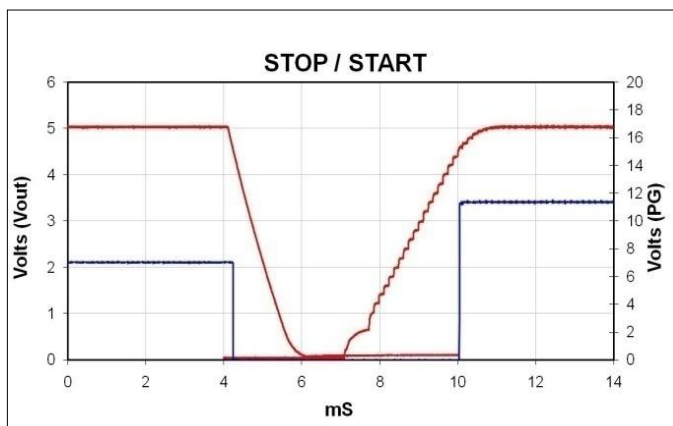
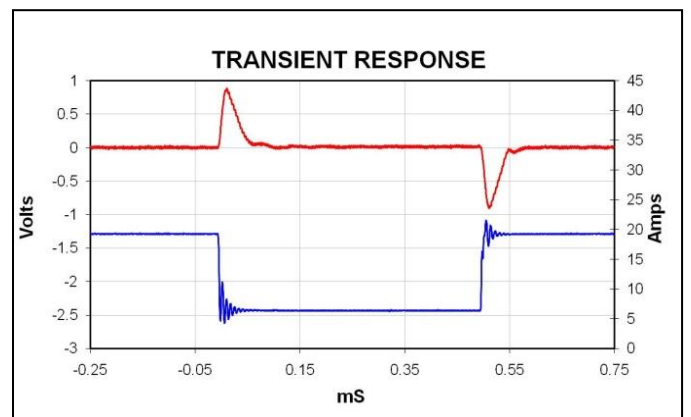
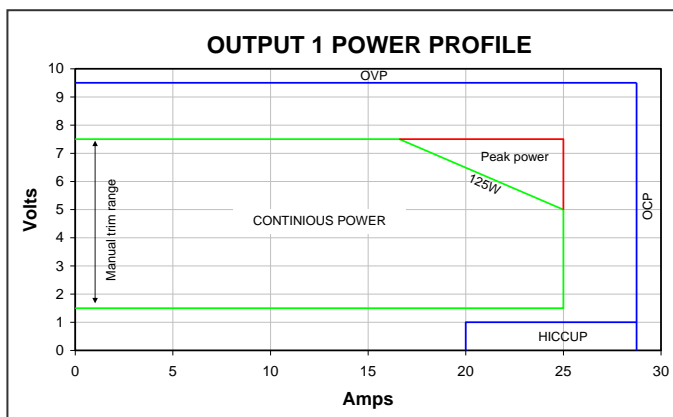

MECHANICAL DIMENSIONS AND MOUNTING SCREWS

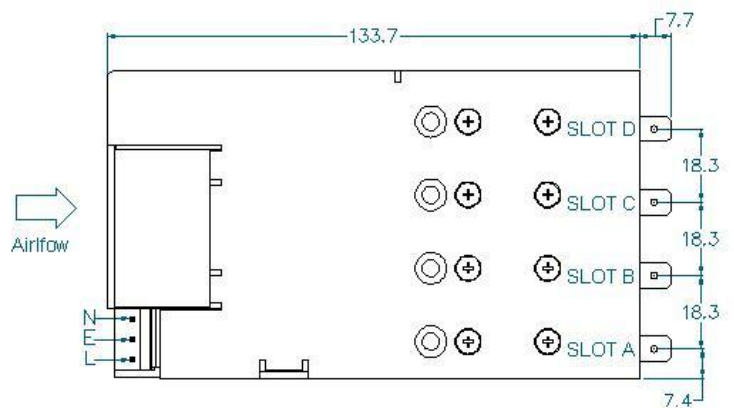
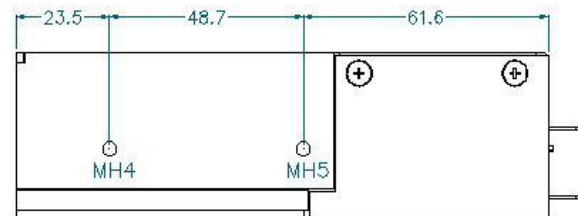
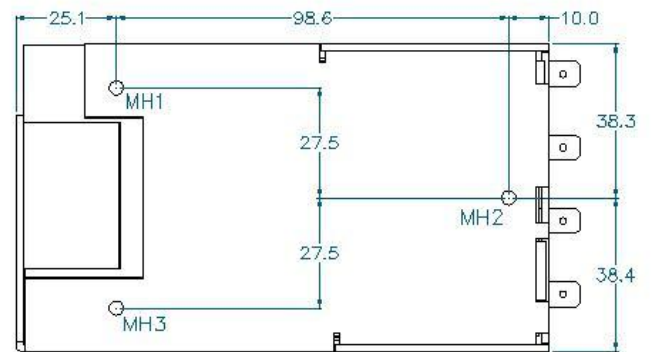
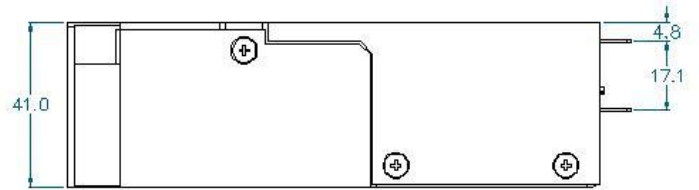
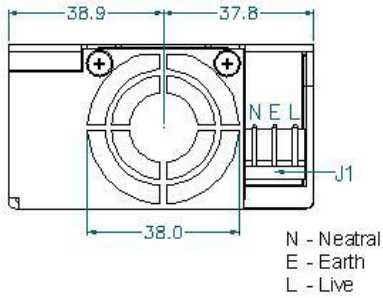

SCREWS	
MH1, MH2, MH3, MH4, MH5	
Screw type	M4
Tightening	Tighten to 1.5 Nm
Penetration depth	4.00mm max including chassis
OUTPUT MODULES x 8	
Screw type	M3x5, C/Sink, Posi, Stainless Steel
Tightening	Tighten to 0.75 Nm
Penetration depth	Defined by screw
CHASSIS x 5	
Screw type	M3x5, C/Sink, Posi, Stainless Steel
Tightening	Tighten to 0.75 Nm
Penetration depth	Defined by screw
FAN x 2	
Screw type	M3x24, C/Sink, Posi, Stainless Steel
Tightening	Tighten to 0.75 Nm
Penetration depth	Defined by screw

CONNECTORS

PINOUTS		
J1		
Circuit	Details	
1	Live	
2	Earth	
3	Neutral	
J2		
Circuit	Details	
1	Power Good	Slot A
2	Inhibit	
3	Power Good	Slot B
4	Inhibit	
5	Power Good	Slot C
6	Inhibit	
7	Power Good	Slot D
8	Inhibit	
9	Global Inhibit	
10	AC OK	
11	+5V 200mA Bias Supply	
12	COM	
J5		
Circuit	Details	
1	-Sense	
2	+Sense	
3	Voltage Control	
4	Current Control / Share / Out	
5	COM	
6	+5V local bias supply	

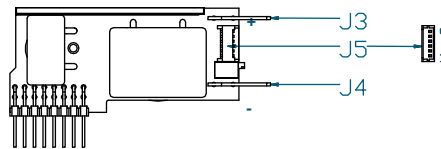
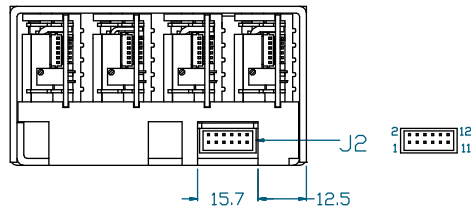
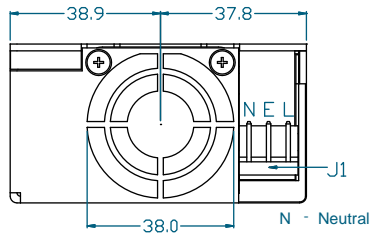

J3
Positive Output
J4
Negative Output

REF.	DETAILS	MANUFACTURER	TERMINAL
J1	MAINS INPUT: 3 Pin, 5.08mm, with Friction Lock, 18-24 AWG	MOLEX	8701031
J2	GLOBAL SIGNALS: 12 Pin, 2mm, with Friction Lock, 24-30 AWG	MOLEX	503948051
J2	IDT ALTERNATIVE FOR J2	MOLEX	0875681263
J3/4(1)	OUTPUT POWER TERMINAL: TAB SIZE 6.35mmx0.8mm	VARIOUS	VARIOUS
J5	OUTPUT SIGNALS: 6 Pin, 1.25mm, with Friction lock, 28-32 AWG	MOLEX	1510210600 50058800

Notes

1. Terminal and Wire current rating must exceed maximum short circuit output current. Eg. Output 1 = 25A*1.25 = 31.25Amps
2. Direct equivalents may be used for any connector parts
3. All cables must be rated 105°C min, equivalent to UL1015

Vox Power Ltd. reserves the right to change or improve any part of the specification, electrical or mechanical design or manufacturing process without notice. Please consult your local distributor or contact Vox Power to ensure that you have the latest specification before using your product. For other information relating to the use of the product please refer to the latest NEVO user manual. Vox Power reserves the right to make changes without notice to any of its products. Vox Power does not assume any liability arising out of the use or application of any of its products and of any information to the maximum extent permitted by law. No license, express or implied, by estoppel or otherwise, to any intellectual property rights is granted by this document or by any conduct of Vox Power. VOX POWER DISCLAIMS ALL WARRANTIES AND REPRESENTATIONS. IN PARTICULAR ALL OTHER WARRANTIES, CONDITION OR TERMS RELATING TO SUITABILITY, FITNESS FOR PURPOSE, MECHANABILITY OR CONDITION OF THE PRODUCTS AND WHETHER EXPRESS OR IMPLIED BY STATUTE OR COMMON LAW OR OTHERWISE ARE EXCLUDED.

Document DOC6027r00