

## Parallel gripper DHPS

**FESTO**



## Characteristics

### At a glance

#### General

- Heavy-duty, precision T-slot guide for gripper jaws
- Oval piston for high gripping forces
- High gripping forces with compact dimensions
- Gripper jaw centring options
- Max. repetition accuracy
- Gripping force backup
- Internal fixed flow control
- Wide range of adaptation options on the drives

- Sensor technology:
  - Adaptable position sensor for the small gripper sizes
  - Integratable proximity switches for the medium and large gripper sizes

#### Flexible range of applications

- Can be used as a double-acting and single-acting gripper
- Compression spring for supporting or backing up the gripping forces
- Suitable for external and internal gripping

### The technology in detail

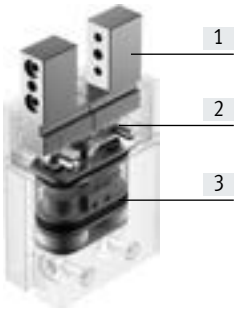

- [1] Gripper jaws
- [2] Reversing lever
- [3] Piston with magnet

#### Note

Engineering software  
Gripper selection  
→ [www.festo.com](http://www.festo.com)

### Position sensing/force control

#### With position transmitter SMAT-8M, SDAT



- Analogue position feedback possible
- Analogue output
    - 0 ... 10 V
    - 4 ... 20 mA

#### With proportional-pressure regulator VPPM



- Infinite adjustment of the gripping force possible
- Setpoint value input
    - 0 ... 10 V
    - 4 ... 20 mA

#### With proximity switch SMT-8G/-10G



- Detecting multiple positions:
- Open
  - Closed
  - Workpiece gripped

## Key features

### Supply ports

At the side

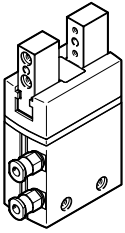

### Mounting options

At the side

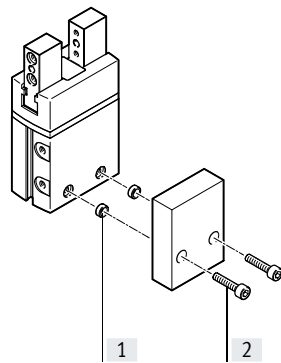
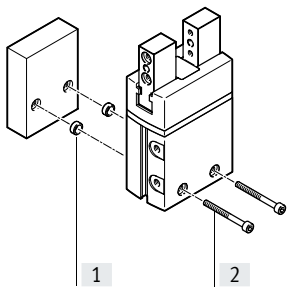

From underneath

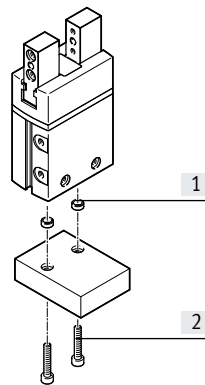

- [1] Centring sleeves
- [2] Retaining screws

### Mounting options for external gripper fingers

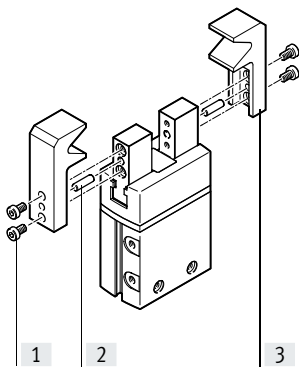

- [1] Retaining screws
- [2] Centring pins
- [3] Gripper finger

#### Note

These grippers are not designed for the following or similar applications:

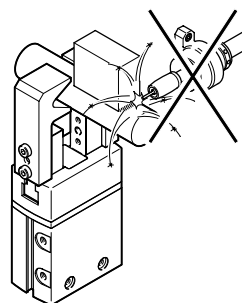

- Welding spatter

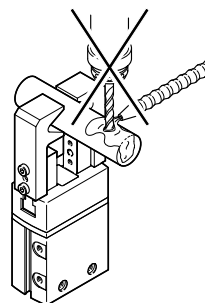

- Machining
- Aggressive media

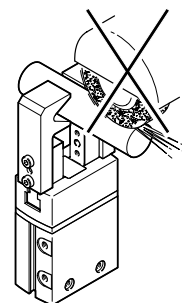

- Grinding dust

## Peripherals overview

### Peripherals overview

DHPS-6

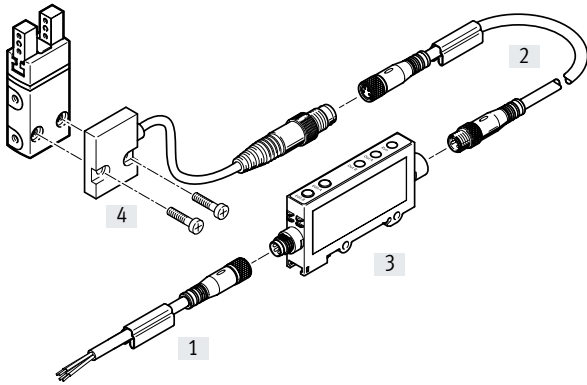

DHPS-10 ... 35

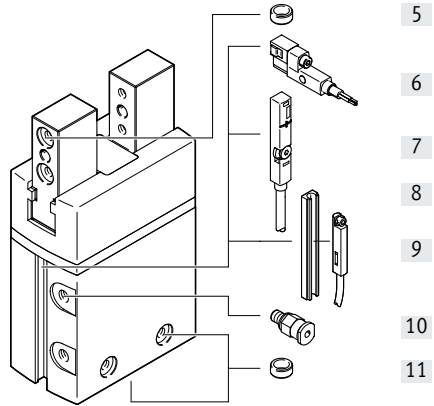

### System product for handling and assembly technology

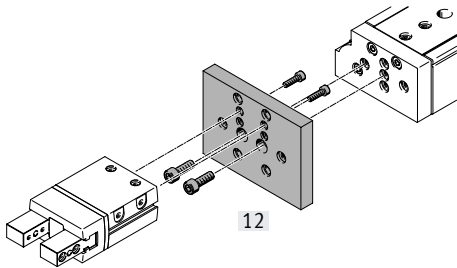

### Proportional-pressure regulator VPPM

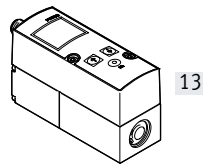

## Peripherals overview

Accessories				
Type	For size	Description	→ Page/Internet	
[1] Connecting cable NEBU	6	• Connection between signal converter and controller	21	
[2] Connecting cable NEBU	6	• Connection between position sensor and signal converter	21	
[3] Signal converter SVE4	6	• For evaluating signals for position sensor SMH-S1	21	
[4] Position sensor SMH-S1	6	• Adaptable and integratable sensor technology, for sensing the piston position	21	
[5] Centring sleeve ZBH	6 ... 35	• For centring the gripper fingers on the gripper jaws • The delivery scope of the gripper for size 10 and above includes 4 centring sleeves	20	
[6] Proximity switch SMT-8G	10 ... 35	• For sensing the piston position • Proximity switch does not project past the housing at the bottom	22	
[7] Position transmitter SMAT-8M	10 ... 35	• Continuously senses the position of the piston. It has an analogue output and an output signal relative to the piston position.	22	
Position transmitter SDAT	35			
[8] Bondable sensor rail HGP-SL	10 ... 35	• Enables the use of proximity switches SME/SMT-10	20	
[9] Proximity switch SMT-10G	10 ... 35	• For sensing the piston position • Proximity switch does not project past the housing at the bottom • With sensor rail HGP-SL10-...	22	
[10] Push-in fitting QS	6 ... 35	• For connecting tubing with standard outside diameters	qs	
[11] Centring sleeve ZBH	6 ... 35	• For centring the gripper during mounting • 2 centring sleeves included in the scope of delivery of the gripper	20	
[12] Adapter kit DHAA, HMSV, HAPG, HAPS, HMVA	6 ... 35	• Connecting plate between drive and gripper	16	
[13] Proportional-pressure regulator VPPM	6 ... 35	• For infinite adjustment of the gripping force	vppm	

Type codes

001	Series
DHPS	Parallel gripper

002	Size
6	6
10	10
16	16
20	20
25	25
35	35



003	Position sensing
A	For proximity sensor

004	Gripping force backup
	None
NC	N/O contact
NO	Opening

## Data sheet

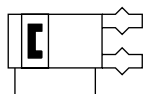
Function  
Double-acting  
DHPS-...-A



-  Size  
6 ... 35 mm
-  Total stroke  
4 ... 25 mm



www.festo.com

Function – Variant  
Single-acting or with gripping force  
backup

Opening: DHPS-...-NO



Closing: DHPS-...-NC

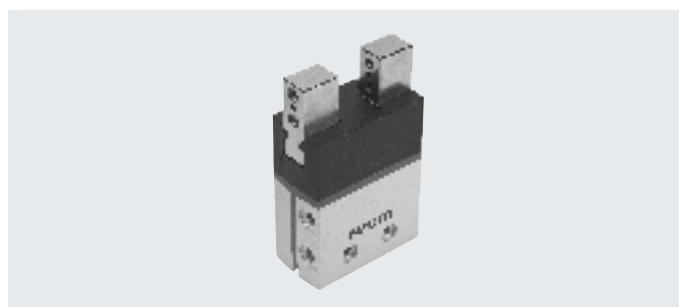

General technical data		6	10	16	20	25	35
Size		6	10	16	20	25	35
Design		Lever					
		Guided motion sequence					
Mode of operation		Double-acting					
Gripper function		Parallel					
Guide		Plain-bearing guide					
Gripping force backup		–	NO, NC	NO, NC	NO, NC	NO, NC	NO, NC
Number of gripper jaws		2					
Max. load per gripper finger <sup>1)</sup>	[g]	10	60	150	250	350	450
Stroke per gripper jaw	[mm]	2	3	5	6.5	7.5	12.5
Pneumatic connection		M3	M3	M3	M5	G1/8	G1/8
Repetition accuracy <sup>2)</sup>	[mm]	≤ 0.02					
Max. interchangeability	[mm]	≤ ±0.2					
Max. operating frequency	[Hz]	4			3		2
Rotational symmetry	[mm]	< ∅ 0.2					
Position sensing		Via position sensor		Via proximity switch, position transmitter			
Type of mounting		With through-hole and centring sleeve					
		With female thread and centring sleeve					
Mounting position		Any					

1) Applies to unthrottled operation

2) Under constant exposure to operating conditions, end-position drift occurs, in the direction of movement of the gripper jaws, at 100 consecutive strokes

Operating and environmental conditions		6	10	16	20	25	35
Size		6	10	16	20	25	35
Min. operating pressure							
DHPS-...-A	[bar]	2					
DHPS-...-A-N	[bar]	–	4				
Max. operating pressure	[bar]	8					
Operating medium		Compressed air to ISO 8573-1:2010 [7:4:4]					
Note on operating/pilot medium		Lubricated operation possible (in which case lubricated operation will always be required)					
Ambient temperature <sup>1)</sup>	[°C]	+5 ... +60					
Corrosion resistance CRC <sup>2)</sup>		1					

1) Note operating range of proximity switches

2) Corrosion resistance class CRC 1 to Festo standard FN 940070

Low corrosion stress. Dry internal application or transport and storage protection. Also applies to parts behind covers, in the non-visible interior area, and parts which are covered in the application (e. g. drive trunnions).

## Data sheet

Weights [g]						
Size	6	10	16	20	25	35
DHPS-...-A	19	67	184	380	700	1285
DHPS-...-A-N	-	68	188	387	713	1345

### Materials

#### Sectional view

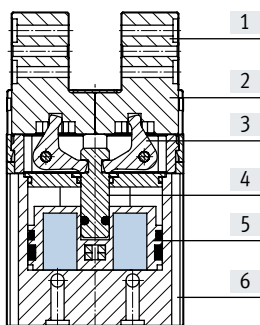

Parallel gripper		
[1]	Gripper jaws	High-alloy stainless steel
[2]	Cover cap	Polyamide
[3]	Reversing lever	Hardened sintered steel
[4]	Piston rod	Tempered steel
[5]	Piston	Polyacetal
[6]	Housing	Hard anodised wrought aluminium alloy
-	Seals	NBR
-	Note on materials	Free of copper and PTFE
		RoHS-compliant

#### Gripping force [N] at 6 bar

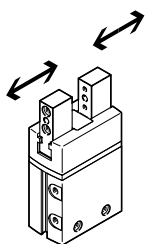

Size		6	10	16	20	25	35
Gripping force per gripper jaw							
DHPS-...-A	Opening	15	39	105	162	249	483
	Closing	13.5	34.5	96	147	228	450
Total gripping force							
DHPS-...-A	Opening	30	80	210	320	500	970
	Closing	25	70	190	290	450	910

#### Characteristic load values at the gripper jaws

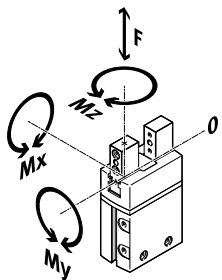

The indicated permissible forces and torques apply to a single gripper jaw. They include the lever arm, additional weight forces created by the workpiece or external gripper fingers and acceleration forces during movement.

The zero coordinate line (gripper jaw guide) must be taken into consideration for the calculation of torques.

Size		6	10	16	20	25	35
Max. permissible force $F_z$	[N]	10	60	150	250	350	450
Max. permissible torque $M_x$	[Nm]	0.5	3	8	14	30	50
Max. permissible torque $M_y$	[Nm]	0.5	3	8	14	30	50
Max. permissible torque $M_z$	[Nm]	0.5	3	8	14	30	50



## Data sheet

### Mass moment of inertia [kgm<sup>2</sup>x10<sup>-4</sup>]

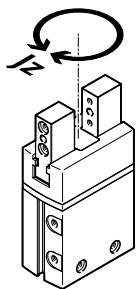

Mass moment of inertia of the parallel gripper in relation to the central axis, without external gripper fingers, with no load.

Size	6	10	16	20	25	35
DHPS-...-A	0.01	0.08	0.47	1.49	3.83	12.70
DHPS-...-A-NO	-	0.08	0.47	1.52	3.92	12.83
DHPS-...-A-NC	-	0.08	0.47	1.49	3.84	12.73

### Gripper jaw backlash

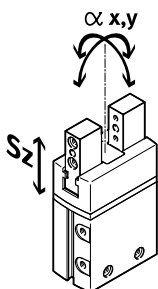

The plain-bearing guide used in the grippers means that there is backlash between the gripper jaws and the housing. The backlash values entered in the table have been calculated in accordance with the traditional accumulative tolerance method.

Size	6	10	16	20	25	35
Max. gripper jaw backlash Sz [mm]	≤ 0.02					
Max. gripper jaw angular backlash ax, ay [°]	≤ 1	≤ 0.5				

### Opening and closing times [ms] at 6 bar

Without external gripper fingers

With external gripper fingers

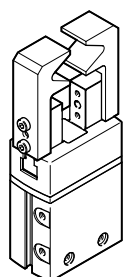
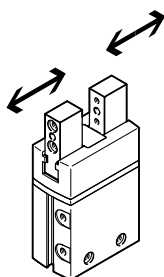

The opening and closing times [ms] given were measured at room temperature at an operating pressure of 6 bar with the gripper horizontally mounted and without additional gripper fingers. The grippers must be throttled for larger weights [g]. Opening and closing times must then be adjusted accordingly.

Size		6	10	16	20	25	35
<b>Without external gripper fingers</b>							
DHPS-...-A	Opening	8	21	33	59	48	95
	Closing	17	28	41	87	63	123
DHPS-...-A-NO	Opening	-	19	32	58	45	88
	Closing	-	30	50	97	78	151
DHPS-...-A-NC	Opening	-	58	48	72	68	131
	Closing	-	24	37	62	52	99
<b>With external gripper fingers (as a function of load per gripper finger)</b>							
DHPS-...	20 g	50	-	-	-	-	-
	100 g	-	50	-	-	-	-
	125 g	-	100	-	-	-	-
	150 g	-	200	-	-	-	-
	200 g	-	-	100	-	-	-
	250 g	-	-	200	-	-	-
	300 g	-	-	300	100	-	-
	350 g	-	-	-	200	-	-
	400 g	-	-	-	300	100	-
	500 g	-	-	-	-	200	-
600 g	-	-	-	-	300	200	
750 g	-	-	-	-	-	300	

Data sheet

Gripping force  $F_H$  per gripper jaw as a function of operating pressure and lever arm  $x$

The gripping forces as a function of the operating pressure and lever arm can be determined from the following graphs.

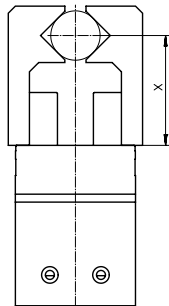

- 2 bar
- · - · 4 bar
- - - 6 bar
- · · · · 8 bar

**Note**  
 Engineering software  
 Gripper selection  
 → [www.festo.com](http://www.festo.com)

External gripping (closing)

DHPS-6

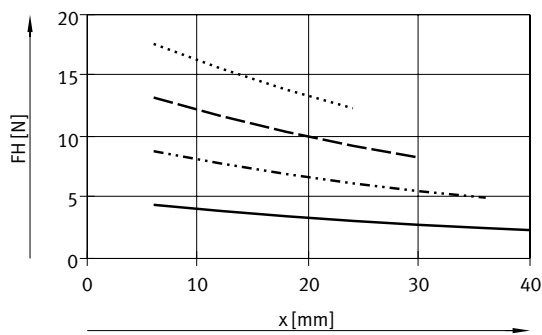

DHPS-10

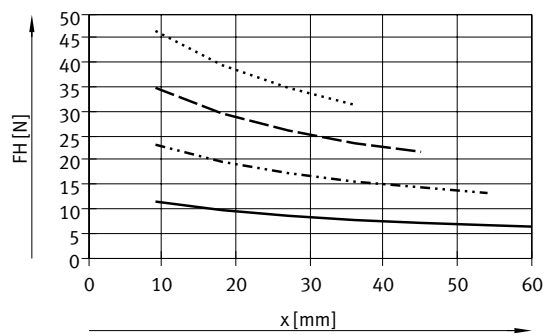

DHPS-16

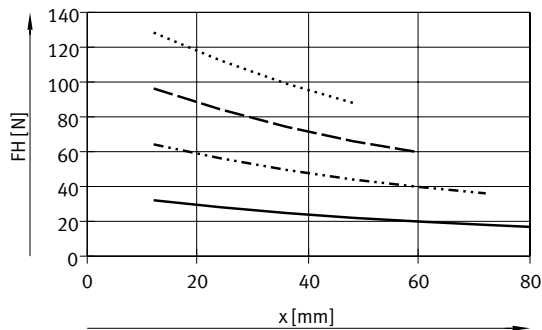

DHPS-20

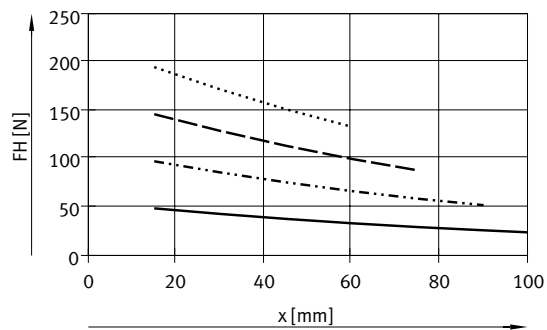

DHPS-25

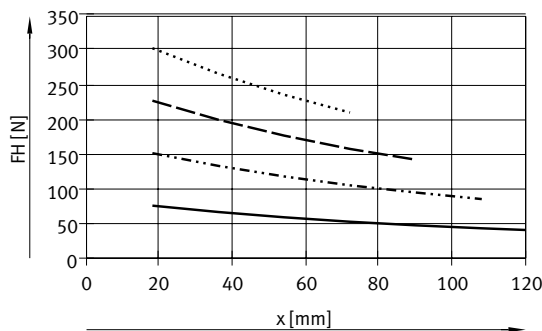

DHPS-35

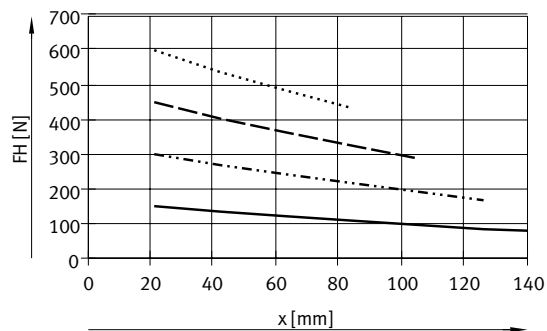

## Data sheet

### Gripping force $F_H$ per gripper jaw as a function of operating pressure and lever arm $x$

The gripping forces as a function of the operating pressure and lever arm can be determined from the following graphs.

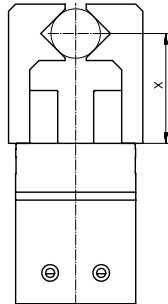

- 2 bar
- · - · 4 bar
- - - 6 bar
- · · · · 8 bar

**Note**  
 Engineering software  
 Gripper selection  
 → [www.festo.com](http://www.festo.com)

### Internal gripping (opening)

DHPS-6

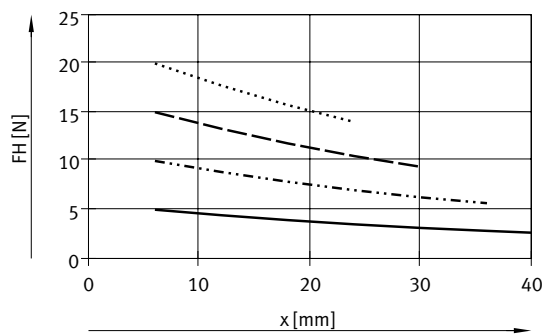

DHPS-10

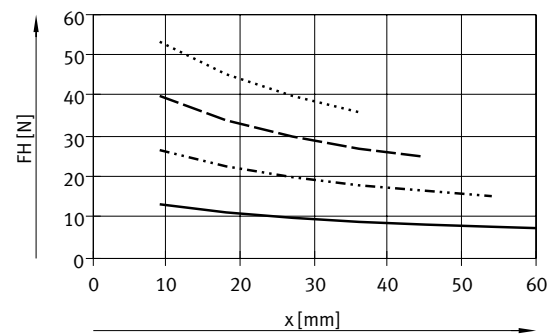

DHPS-16

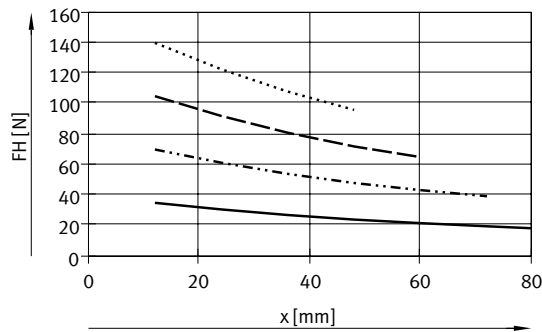

DHPS-20

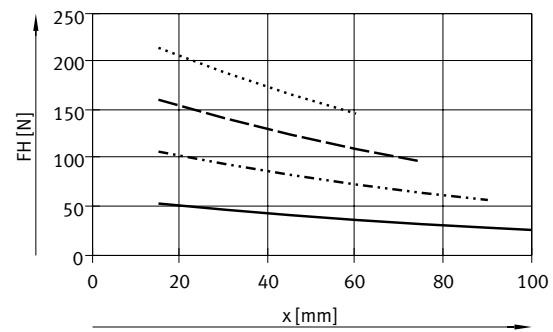

DHPS-25

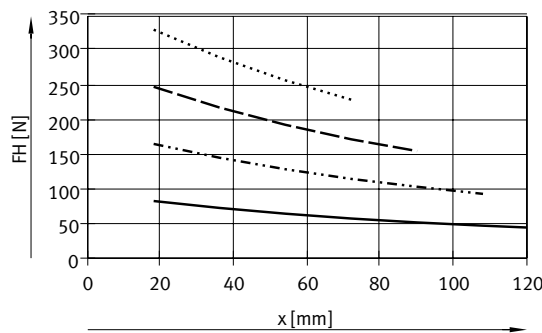

DHPS-35

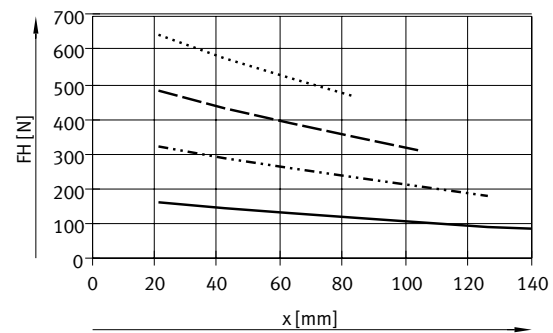

## Data sheet

### Gripping force $F_H$ per gripper jaw at 6 bar as a function of lever arm $x$ and eccentricity $a$ and $b$

The following formula must be used to calculate the lever arm  $x$  with eccentric gripping:

$$x = \sqrt{a^2 + b^2}$$

The gripping force  $F_H$  can be read from the graphs (→ page 10) using the calculated value  $x$ .

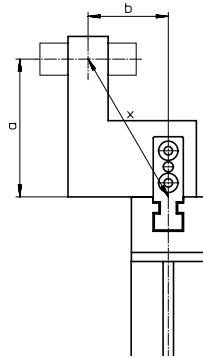

### Calculation example

Given:

Distance  $a = 25$  mm

Distance  $b = 20$  mm

To be calculated:

The gripping force at 6 bar with a DHPS-16, used as an external gripper

Procedure: Calculating the lever arm  $x$

$$x = \sqrt{25^2 + 20^2}$$

$$x = 32$$
 mm

The graph

(→ page 10) gives a value for the gripping force of  $F_H = 79$  N.

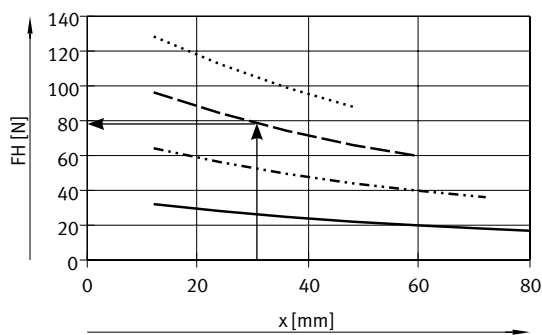

## Data sheet

### Spring force $F_F$ as a function of size and total gripper jaw stroke $l$

Gripping force backup for DHPS-...-N...

The spring forces  $F_F$  as a function of gripper jaw stroke  $l$  can be determined from the following graph.

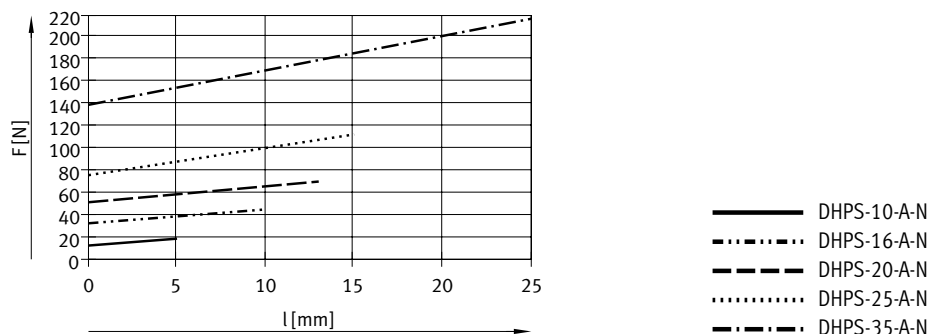

### Spring force $F_F$ as a function of size, gripper jaw stroke $l$ and lever arm $x$ per gripper finger

The lever arm  $x$  must be taken into consideration when determining the actual spring force  $F_{Ftotal}$ .

The formulae for calculating the spring force are provided in the table below.

Gripping force backup	Size	$F_{Ftotal}$ per gripper finger
NO, NC	10	$-0.02 * x + 0.5 * F_F$
	16	$-0.08 * x + 0.5 * F_F$
	20	$-0.1 * x + 0.5 * F_F$
	25	$-0.12 * x + 0.5 * F_F$
	35	$-0.19 * x + 0.5 * F_F$

### Determination of the actual gripping forces $F_{Gr}$ for DHPS-...-NO and DHPS-...-NC as a function of application

The parallel grippers with integrated spring type DHPS-...-NO (opening gripping force backup) and DHPS-...-NC (closing gripping force backup) can be used as

- single-acting grippers
- grippers with supplementary gripping force and
- grippers with gripping force backup depending on requirements.

In order to calculate the available gripping forces  $F_{Gr}$  (per gripper jaw), the gripping force  $F_H$  and spring force  $F_{Ftotal}$  must be combined accordingly.

#### Application

Single-acting	Supplementary gripping force	Gripping force backup
<ul style="list-style-type: none"> <li>• Gripping with spring force: <math>F_{Gr} = F_{Ftotal}</math></li> <li>• Gripping with pressure force: <math>F_{Gr} = F_H - F_{Ftotal}</math></li> </ul>	<ul style="list-style-type: none"> <li>• Gripping with pressure and spring force: <math>F_{Gr} = F_H + F_{Ftotal}</math></li> </ul>	<ul style="list-style-type: none"> <li>• Gripping with spring force: <math>F_{Gr} = F_{Ftotal}</math></li> </ul>

Data sheet

Dimensions

Download CAD data → [www.festo.com](http://www.festo.com)

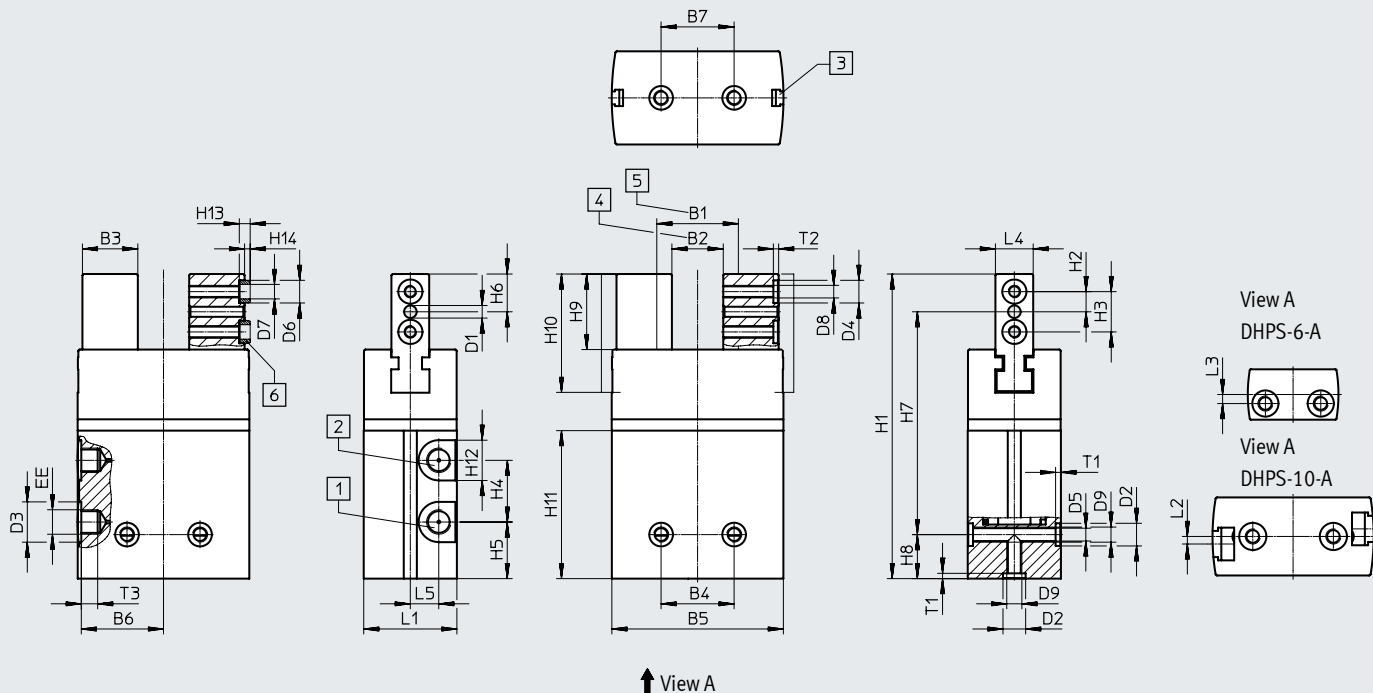

- [1] Supply port, opening
- [2] Supply port, closing
- [3] Slot for proximity switch
- [4] Normal position for DHPS...-A and DHPS...-A-NC
- [5] Normal position for DHPS...-A-NO
- [6] Centring sleeves ZBH (size 10 and above: 4 included in the scope of delivery)
- [7] Mounting interface: centring sleeves ZBH for mounting the gripper (2 included in the scope of delivery)

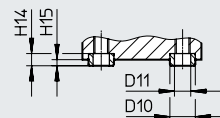

Size	B1	B2	B3	B4 <sup>1)</sup>	B5	B6	B7 <sup>1)</sup>	D1	D2	D3	D4
[mm]	±0.5	±0.5	-0.03		±0.1			∅ H8	∅ H8	∅	∅ H8
6	10	6	5.5	11	18	8.65	11	1.5	5	7	-
10	21.8	15.8	7	16	32	15.4	16	2	5	7	5
16	27.8	17.8	13	25	47	22.65	25	3	7	7	7
20	30	17	17.5	25	55.6	26.65	25	4	7	10	7
25	35.4	20.4	22	29	68.2	32.65	29	4	9	16	9
35	56	31	27	33	88	42.25	33	5	12	16	9

1) Tolerance for centring hole ±0.02 mm; tolerance for thread ±0.1 mm

## Data sheet

Size [mm]	D5 ∅ +0.1	D6 ∅ h7	D7 ∅	D8	D9	D10 ∅ h7	D11 ∅	EE	H1	H2	H3 <sup>1)</sup>
6	2.5	–	–	M2	M3	–	–	M3	45.5	2.9	5.8
10	2.5	5	3.2	M3	M3	5	3.2	M3	66	4	8
16	3.3	7	5.3	M4	M4	5	3.2	M3	80	5.5	11
20	3.3	7	5.3	M4	M4	7	5.3	M5	101	7	14
25	5.1	9	6.4	M5	M6	9	6.4	G1/8	121	8	16
35	6.4	9	6.4	M6	M8	12	10.3	G1/8	142	8.5	17

Size [mm]	H4	H5	H6	H7 ±0.2	H8 <sup>2)</sup>	H9	H10	H11	H12	H13 –0.2	H14 –0.3
6	15	4	5	33	7.5	9.55	15.8	25.3	7	–	–
10	15.5	10.5	7.5	51	7.5	15.2	23	35	7	2.4	1.2
16	18	11	10	62.5	7.5	20	32.5	38.1	7	3	1.4
20	23	16	12.5	81	7.5	25	39.5	50	10	3	1.4
25	24.5	22.5	15	88.5	17.5	30	47	58.8	16	4	1.9
35	29	24	16	108.5	17.5	32	53	65.3	16	4	1.9

Size [mm]	H15 –0.2	H16 –0.3	L1	L2	L3 <sup>1)</sup>	L4 –0.05	L5	T1 +0.1	T2 +0.1	T3 +0.5
6	–	–	10 <sup>+0.1</sup>	–	1.8	5	1.5	1.2	–	3.5
10	2.4	1.2	15.5 <sup>+0.1</sup>	1.5	–	7	5	1.2	1.2	5
16	3	1.4	22 <sup>+0.1</sup>	–	–	10	7	1.6	1.6	6
20	3	1.4	30±0.1	–	–	12	9	1.6	1.6	6
25	4	1.9	37±0.1	–	–	15	11.3	2.1	2.1	6.5
35	4	1.9	45 <sup>+0.1</sup>	–	–	20	13.5	2.6	2.1	6.5

1) Tolerance for centring hole ±0.02 mm; tolerance for thread ±0.1 mm

2) Tolerance for centring hole ±0.05 mm; tolerance for thread ±0.1 mm

## Ordering data

Size [mm]	Double-acting without compression spring		Single-acting or with gripping force backup			
	Part no.	Type	Opening		Closing	
	Part no.	Type	Part no.	Type	Part no.	Type
6	1254039	DHPS-6-A	–		–	
10	1254040	DHPS-10-A	1254041	DHPS-10-A-NO	1254042	DHPS-10-A-NC
16	1254043	DHPS-16-A	1254044	DHPS-16-A-NO	1254045	DHPS-16-A-NC
20	1254046	DHPS-20-A	1254047	DHPS-20-A-NO	1254048	DHPS-20-A-NC
25	1254049	DHPS-25-A	1254050	DHPS-25-A-NO	1254051	DHPS-25-A-NC
35	1254052	DHPS-35-A	1254053	DHPS-35-A-NO	1254054	DHPS-35-A-NC

Accessories

Adapter kit  
HAPG, HAPS, HMSV

Material:  
Wrought aluminium alloy  
Free of copper and PTFE  
RoHS-compliant

 **Note**  
The kit includes the individual mounting interface as well as the necessary mounting material.

Permissible drive/gripper combinations with adapter kit

Download CAD data → [www.festo.com](http://www.festo.com)

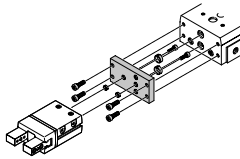
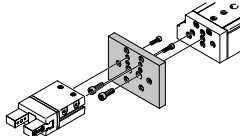
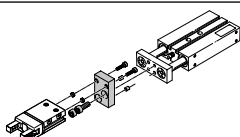
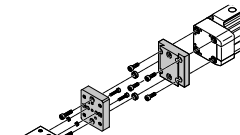
Combination	Drive Size	Gripper		Adapter kit			
		Size	Mounting option		CRC <sup>1)</sup>	Part no.	Type
	<b>DGST</b>	<b>DHPS</b>			<b>DHAA</b>		
	6	6	■	■	2	8161981	DHAA-G-G8-6-B18-6
	8	6	■	■		8161977	DHAA-G-G8-8-B18-6
	10	10	■	■		8161979	DHAA-G-G8-10-B18-10
	12	10	■	■		8161978	DHAA-G-G8-12-B18-10
	16	16	■	■		8161980	DHAA-G-G8-16-B18-16
	20	20	■	■		8161976	DHAA-G-G8-20-B18-20
	25	25	■	■		8161975	DHAA-G-G8-25-B18-25
	<b>DGSL</b>	<b>DHPS</b>			<b>HMSV</b>		
	4, 6	6	■	■	2	548783	HMSV-53
	8, 10	10	■	■		548784	HMSV-54
	12, 16	16	■	■		548785	HMSV-55
	20, 25	20, 25	■	■		548786	HMSV-56
	<b>DPZ</b>	<b>DHPS</b>			<b>HAPG</b>		
	10, 16	10	■	–	2	163250	HAPG-1
	16	16, 20	■	–		163251	HAPG-2
	20	16, 20	■	–		163252	HAPG-3
	25, 32	25	■	–		163253	HAPG-4
	<b>DGPL</b>	<b>DHPS</b>			<b>HMVA, HAPG, HMSV</b>		
	<b>Direct mounting</b>						
	25, 32	6	■	■	2	196788	HMVA-DLA1 8/25
						192706	HAPG-37-S1
	40	6	■	■		196790	HMVA-DLA40
						192706	HAPG-37-S1
	25, 32	10	■	■		196788	HMVA-DLA1 8/25
						192705	HAPG-36-S1
	40	10	■	■		196790	HMVA-DLA40
						192705	HAPG-36-S1
	25, 32	16	■	■		196788	HMVA-DLA1 8/25
					193922	HAPG-37-S4	
40	16	■	■		196790	HMVA-DLA40	
					193922	HAPG-37-S4	

1) Corrosion resistance class CRC 2 to Festo standard FN 940070

Moderate corrosion stress. Indoor applications in which condensation can occur. External visible parts with primarily decorative surface requirements which are in direct contact with a normal industrial environment.



## Accessories



Adapter kit  
DHAA, HAPG

Material:  
Wrought aluminium alloy  
Free of copper and PTFE  
RoHS-compliant



**Note**

The kit includes the individual mounting interface as well as the necessary mounting material.

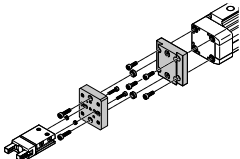
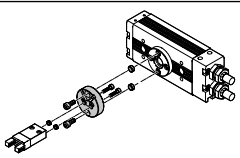
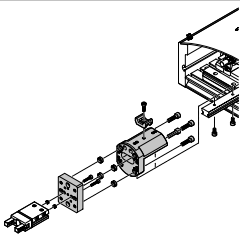
Permissible drive/gripper combinations with adapter kit							Download CAD data → <a href="http://www.festo.com">www.festo.com</a>		
Combination	Drive Size	Gripper		Adapter kit		CRC <sup>1)</sup>	Part no.	Type	
		Size	Mounting option						
	<b>DGPL</b>	<b>DHPS</b>			<b>HMVA, HAPG, HMSV</b>				
	<b>Dovetail mounting</b>								
	25	10	■	■	2	196788	HMVA-DLA1 8/25		
						177767	HMSV-27		
	40	10	■	■		196790	HMVA-DLA40		
						177767	HMSV-27		
	25	16	■	■		196788	HMVA-DLA1 8/25		
						177768	HMSV-28		
	40	16	■	■		196790	HMVA-DLA40		
						177768	HMSV-28		
40	25	■	■		196790	HMVA-DLA40			
					177769	HMSV-29			
40	35	■	■		196790	HMVA-DLA40			
					177770	HMSV-30			
	<b>DRRD</b>	<b>DHPS</b>			<b>DHAA</b>				
	8	6	■	■	2	2808892	DHAA-G-Q11-8-B1-6		
	10	6	■	■		2807644	DHAA-G-Q11-10-B1-6		
	12	6	■	■		2805783	DHAA-G-Q11-12-B1-6		
	12	10	■	■		2802687	DHAA-G-Q11-12-B1-10		
	16	10	■	■		2190504	DHAA-G-Q11-16-B1-10		
	16	16	■	■		2190393	DHAA-G-Q11-16-B1-16		
	16	20	■	■		2187838	DHAA-G-Q11-16-B1-20		
	20	16	■	■		2190284	DHAA-G-Q11-20-B1-16		
	20	20	■	■		2187713	DHAA-G-Q11-20-B1-20		
	20	25	■	■		2185820	DHAA-G-Q11-20-B1-25		
	25	16	■	■		1471634	DHAA-G-Q11-25-B1-16		
	25	20	■	■		1722652	DHAA-G-Q11-25-B1-20		
	25	25	■	■		1725707	DHAA-G-Q11-25-B1-25		
	32	25	■	■		2186909	DHAA-G-Q11-32-B1-25		
	32	35	■	■		2187316	DHAA-G-Q11-32-B1-35		
35, 40	35	■	■		2187606	DHAA-G-Q11-3 5/40-B1-35			
	<b>HSP</b>	<b>DHPS</b>			<b>HAPG</b>				
	12	6	■	–	2	192709	HAPG-60-S1		
						540881	HAPG-70-B		
	16	6	■	–		192706	HAPG-37-S1		
						540882	HAPG-71-B		
	16	10	■	–		192705	HAPG-36-S1		
						540882	HAPG-71-B		
	25	10	■	–		192705	HAPG-36-S1		
					540883	HAPG-72-B			
25	16	■	–		193922	HAPG-37-S4			
					540883	HAPG-72-B			

1) Corrosion resistance class CRC 2 to Festo standard FN 940070

Moderate corrosion stress. Indoor applications in which condensation can occur. External visible parts with primarily decorative surface requirements which are in direct contact with a normal industrial environment.

Accessories



Adapter kit  
DHAA, HAPG

Material:  
Wrought aluminium alloy  
Free of copper and PTFE  
RoHS-compliant

 **Note**  
The kit includes the individual mounting interface as well as the necessary mounting material.

Permissible drive/gripper combinations with adapter kit

Download CAD data → [www.festo.com](http://www.festo.com)

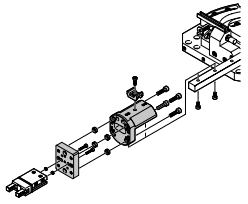
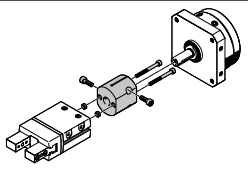
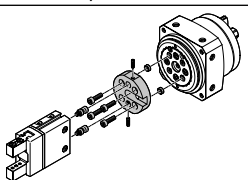
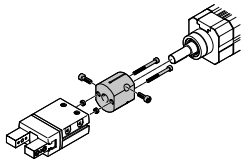
Combination	Drive Size	Gripper Size	Mounting option		Adapter kit		
					CRC <sup>1)</sup>	Part no.	Type
	12, 16	DHPS 6	■	–	2	192706	HAPG-37-S1
		DHPS 10	■	–		540882	HAPG-71-B
	12, 16	DHPS 10	■	–		192705	HAPG-36-S1
		DHPS 10	■	–		540882	HAPG-71-B
	DSM-...-FW 6, 8, 10	DHPS 6	■	■	2	187568	HAPG-34
	DSM-... 12, 16, 16, 25, 25, 32	DHPS 10	■	■	2	163266	HAPG-17
		DHPS 10	■	■		163267	HAPG-18
		DHPS 16, 20	■	■		163268	HAPG-19
		DHPS 16, 20	■	■		163269	HAPG-20
		DHPS 25	■	■		163270	HAPG-21
		DHPS 25	■	■		163271	HAPG-22
	DSM-...-HD 12	DHPS 6	■	■	2	8071899	DHAA-G-R3-12-B18-6
	DSM-...-HD 12	DHPS 10	■	■		8072157	DHAA-G-R3-12-B18-10
	DSM-...-HD 16	DHPS 10	■	■		8071917	DHAA-G-R3-16-B18-10
	DSM-...-HD 16	DHPS 16	■	■		8079173	DHAA-G-R3-16-B18-16
	DSM-...-HD 25	DHPS 16, 20	■	■		8071956	DHAA-G-R3-25-B18-16
	DSM-...-HD 32	DHPS 25	■	■		8079208	DHAA-G-R3-32-B18-25
	DSL 16, 20, 20, 25, 25, 32	DHPS 10	■	■	2	163266	HAPG-17
		DHPS 10	■	■		163267	HAPG-18
		DHPS 16, 20	■	■		163268	HAPG-19
		DHPS 16, 20	■	■		163269	HAPG-20
		DHPS 25	■	■		163270	HAPG-21
		DHPS 25	■	■		163271	HAPG-22

1) Corrosion resistance class CRC 2 to Festo standard FN 940070

Moderate corrosion stress. Indoor applications in which condensation can occur. External visible parts with primarily decorative surface requirements which are in direct contact with a normal industrial environment.



## Accessories

**Adapter kit**  
DHAA, HAPG, HMSV

Material:  
Wrought aluminium alloy  
Free of copper and PTFE  
RoHS-compliant

 **Note**

The kit includes the individual mounting interface as well as the necessary mounting material.

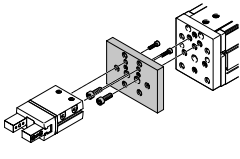
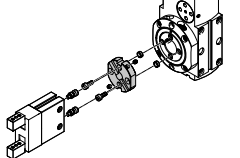
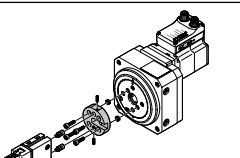
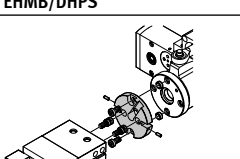
Permissible drive/gripper combinations with adapter kit					Download CAD data → <a href="http://www.festo.com">www.festo.com</a>		
Combination	Drive Size	Gripper Size	Mounting option		Adapter kit		
					CRC <sup>1)</sup>	Part no.	Type
	<b>EGSL</b>	<b>DHPS</b>			2		
	35	6	■	■		548783	HMSV-53
	35	10	■	■		1088262	HMSV-70
	45, 55	16	■	■		548784	HMSV-54
	75	20, 25	■	■		1088262	HMSV-70
					548785	HMSV-55	
					548786	HMSV-56	
	<b>ERMB</b>	<b>DHPS</b>			2		
	20	16, 20	■	■		184479	HAPG-SD2-3
	25	16, 20	■	■		184482	HAPG-SD2-6
	20	25	■	■		184480	HAPG-SD2-4
	25	25	■	■		184483	HAPG-SD2-7
	32	25	■	■		184485	HAPG-SD2-9
	32	35	■	■		184486	HAPG-SD2-10
	<b>ERMO</b>	<b>DHPS</b>			2		
	12	6	■	■		8071899	DHAA-G-R3-12-B18-6
	12	10	■	■		8072157	DHAA-G-R3-12-B18-10
	16	10	■	■		8071917	DHAA-G-R3-16-B18-10
	16	16	■	■		8079173	DHAA-G-R3-16-B18-16
	25	16, 20	■	■		8071956	DHAA-G-R3-25-B18-16
	32	25	■	■		8079208	DHAA-G-R3-32-B18-25
	<b>EHMB</b>	<b>DHPS</b>			2		
	20	25	■	■		184485	HAPG-SD2-9
	20	35	■	■		184486	HAPG-SD2-10
	25, 32	35	■	■		526027	HAPG-SD2-21

1) Corrosion resistance class CRC 2 to Festo standard FN 940070

Moderate corrosion stress. Indoor applications in which condensation can occur. External visible parts with primarily decorative surface requirements which are in direct contact with a normal industrial environment.

## Accessories

### Sensor rail HGP-SL

bondable

Material:

Wrought aluminium alloy

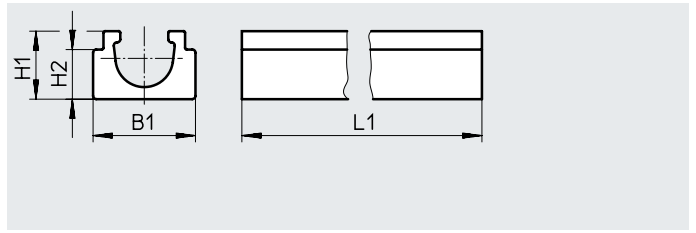

#### Dimensions and ordering data

For size [mm]	B1 +0.05	H1 +0.05/-0.1	H2 -0.1	L1	Weight [g]	Part no.	Type
10	4.25	3.1	6.4	35	1.4	<b>535582</b>	<b>HGP-SL-10-10</b>
16				38	1.5	<b>535583</b>	<b>HGP-SL-10-16</b>
20				50	2.0	<b>535584</b>	<b>HGP-SL-10-20</b>
25				58	2.3	<b>535585</b>	<b>HGP-SL-10-25</b>
35				65	2.6	<b>535586</b>	<b>HGP-SL-10-35</b>

#### Ordering data

For size [mm]	Description	Weight [g]	Part no.	Type	PE <sup>1)</sup>	
Centring sleeve ZBH <span style="float: right;">Data sheets → Internet: zbh</span>						
	10	For centring the gripper fingers on the gripper jaws	1	<b>8146543</b>	<b>ZBH-5-B</b>	10
	16, 20		1	<b>8146544</b>	<b>ZBH-7-B</b>	
	25, 35		1	<b>8137184</b>	<b>ZBH-9-B</b>	
	6, 10	For centring the gripper during mounting	1	<b>8146543</b>	<b>ZBH-5-B</b>	
	16, 20		1	<b>8146544</b>	<b>ZBH-7-B</b>	
	25		1	<b>8137184</b>	<b>ZBH-9-B</b>	
	35		1	<b>8137185</b>	<b>ZBH-12-B</b>	

1) Packaging unit

## Accessories

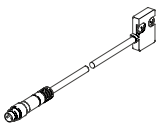
Ordering data				
Type	For size	Weight [g]	Part no.	Type
Position sensor SMH-S1 <span style="float: right;">Data sheets → Internet: smh-s1</span>				
	6	20	175710	SMH-S1-HGP06

**Installation instructions for position sensor SMH-S1**

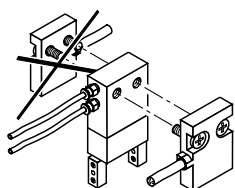

To ensure the position sensor functions correctly, the cable outlet and the tubing outlet must point in the same direction when installed.

**Signal converter SVE4 for position sensor SMH-S1**

- Converts analogue signals into switching points
- Switching function freely programmable with teach-in
- Threshold value, hysteresis or window comparator

Ordering data							
Type	For size	Input connection	Output connection	Switching output	Weight [g]	Part no.	Type
Signal converter SVE4 <span style="float: right;">Data sheets → Internet: sve4</span>							
	6	Socket M8x1, 4-pin	Plug M8x1, 4-pin	2x PNP	19	544216	SVE4-HS-R-HM8-2P-M8
				2x NPN		544219	SVE4-HS-R-HM8-2N-M8

**Ordering data – Connecting cables**

Ordering data – Connecting cables						Data sheets → Internet: nebu
	Electrical connection, left	Electrical connection, right	Cable length [m]	Part no.	Type	
<b>Connection between position sensor and signal converter</b>						
	Straight socket, M8x1, 4-pin	Straight plug M8x1, 4-pin	2.5	554035	NEBU-M8G4-K-2.5-M8G4	
<b>Connection between signal converter and controller</b>						
	Straight socket, M8x1, 4-pin	Cable, open end, 4-wire	2.5	541342	NEBU-M8G4-K-2.5-LE4	
			5	541343	NEBU-M8G4-K-5-LE4	
	Angled socket, M8x1, 4-pin	Cable, open end, 4-wire	2.5	541344	NEBU-M8W4-K-2.5-LE4	
			5	541345	NEBU-M8W4-K-5-LE4	

## Accessories

### Proximity switch for size 10 ... 35

#### Ordering data – Proximity switch for T-slot, magneto-resistive

Data sheets → Internet: smt

	Type of mounting	Electrical connection, outlet direction of connection	Switching output	Cable length [m]	Part no.	Type
<b>N/O contact</b>						
	Inserted in the slot lengthwise	Cable, 3-wire, crosswise	PNP	2.5	547859	SMT-8G-PS-24V-E-2,5Q-OE
		Plug M8x1, 3-pin, crosswise		0.3	547860	SMT-8G-PS-24V-E-0,3Q-M8D
		Cable, 3-wire, crosswise	NPN	2.5	8065028	SMT-8G-NS-24V-E-2,5Q-OE
		Plug M8x1, 3-pin, crosswise		0.3	8065027	SMT-8G-NS-24V-E-0,3Q-M8D

### Proximity switch for size 10 ... 35, with sensor rail HGP-SL10-...



#### Ordering data – Proximity switch for C-slot, magneto-resistive

Data sheets → Internet: smt

	Type of mounting	Electrical connection, outlet direction of connection	Switching output	Cable length [m]	Part no.	Type
<b>N/O contact</b>						
	Inserted in the slot lengthwise	Cable, 3-wire, crosswise	PNP	2.5	547862	SMT-10G-PS-24V-E-2,5Q-OE
		Plug M8x1, 3-pin, crosswise		0.3	547863	SMT-10G-PS-24V-E-0,3Q-M8D
		Cable, 3-wire, crosswise	NPN	2.5	8065030	SMT-10G-NS-24V-E-2,5Q-OE
		Plug M8x1, 3-pin, crosswise		0.3	8065029	SMT-10G-NS-24V-E-0,3Q-M8D

#### Ordering data – Connecting cables

Data sheets → Internet: nebu

	Electrical connection, left	Electrical connection, right	Cable length [m]	Part no.	Type
	Straight socket, M8x1, 3-pin	Cable, open end, 3-wire	2.5	541333	NEBU-M8G3-K-2.5-LE3
			5	541334	NEBU-M8G3-K-5-LE3
	Angled socket, M8x1, 3-pin	Cable, open end, 3-wire	2.5	541338	NEBU-M8W3-K-2.5-LE3
			5	541341	NEBU-M8W3-K-5-LE3

## Position transmitter

The position transmitter continuously senses the position of the piston.

It has an analogue output and an output signal relative to the piston position.



#### Ordering data – Position transmitter for T-slot

Data sheets → Internet: position transmitter

	For size	Position measuring range	Analogue output		Type of mounting	Electrical connection	Cable length [m]	Part no.	Type
			[V]	[mA]					
	10 ... 35	0 ... 40	0 ... 10	–	Inserted in the slot from above	Plug M8x1, 4-pin, in-line	0.3	553744	SMAT-8M-U-E-0,3-M8D
	35	0 ... 50	–	4 ... 20	Inserted in the slot from above	Plug M8x1, 4-pin, in-line	0.3	1531265	SDAT-MHS-M50-1L-SA-E-0.3-M8

#### Ordering data – Connecting cables

Data sheets → Internet: nebu

	Electrical connection, left	Electrical connection, right	Cable length [m]	Part no.	Type
	Straight socket, M8x1, 4-pin	Cable, open end, 4-wire	2.5	541342	NEBU-M8G4-K-2.5-LE4
			5	541343	NEBU-M8G4-K-5-LE4
	Angled socket, M8x1, 4-pin	Cable, open end, 4-wire	2.5	541344	NEBU-M8W4-K-2.5-LE4
			5	541345	NEBU-M8W4-K-5-LE4