

THIS DRAWING IS UNPUBLISHED. RELEASED FOR PUBLICATION 2008  
 © COPYRIGHT 2008 BY TYCO ELECTRONICS CORPORATION. ALL RIGHTS RESERVED.

LOC	DIST	REVISIONS			
P	LTR	DESCRIPTION	DATE	DWN	APVD
A1	-	F1	NEW CAD DRAWING CREATED	17SEP2008	Raab Goe.

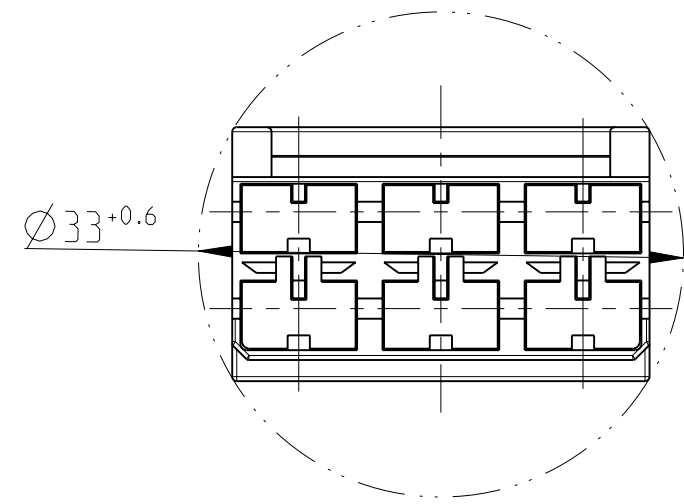

Schnitt Section A-A

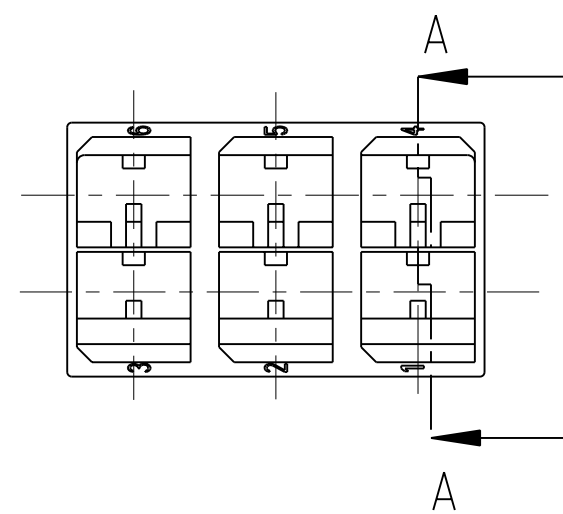
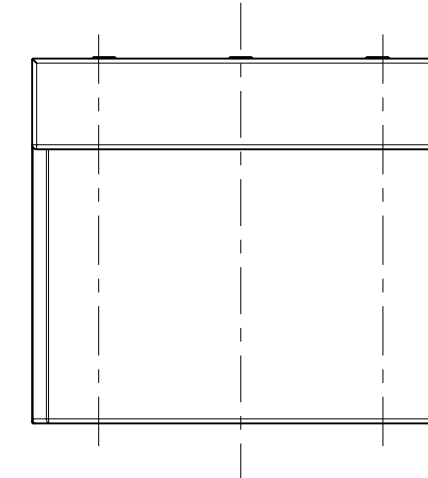
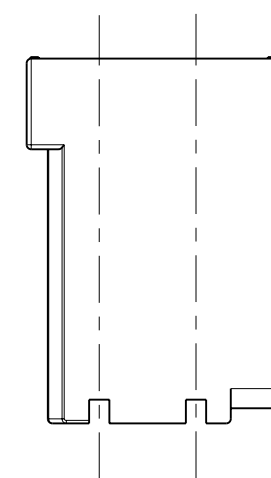
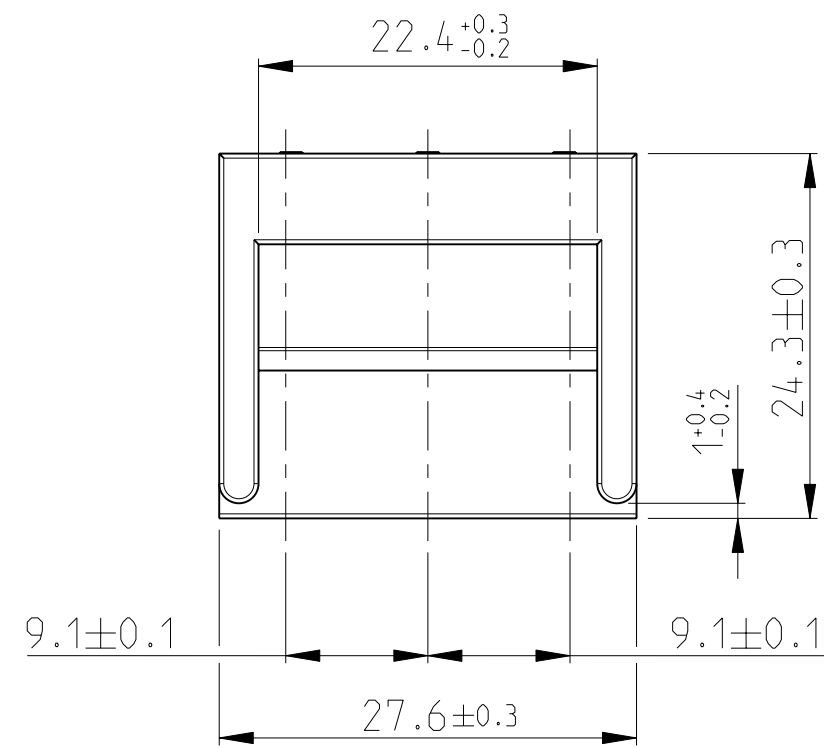
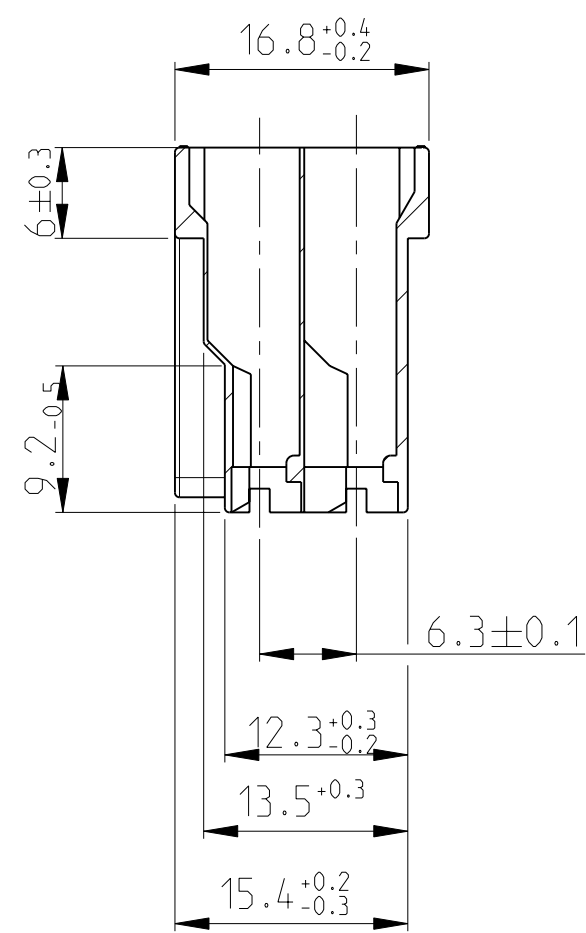

1:1

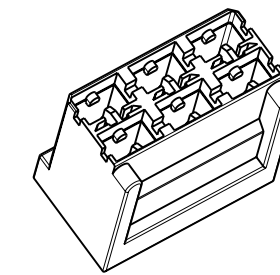

weiß/ WHITE RAL 9001	PA 6.6	926330-8
blau/ BLUE RAL 5012	PA 6.6	926330-7
gelb/ YELLOW RAL 1018	PA 6.6	926330-6
grün/ GREEN RAL 6011	PA 6.6	926330-5
rot/ RED RAL 3000	PA 6.6	926330-4
natur/ NARURAL	PA 6.6	926330-3
grau/ GREY RAL 7037	PA 6.6	926330-2
schwarz/ BLACK	PA 6.6	926330-1
COLOR	MATERIAL	PARTNUMBER

Bemerkungen  
NOTES:

- 1 Nicht vermaßte Wanddicken 1 <sup>+0.2</sup>/<sub>-0.4</sub>  
WALL THICKNESS 1 <sup>+0.2</sup>/<sub>-0.4</sub> EXEPT AS NOTED
- 2 Nicht vermaßte Radien R0.3<sup>+0.2</sup>  
ALL RADII R0.3<sup>+0.2</sup> EXEPT AS NOTED

DIMENSIONS:		TOLERANCES UNLESS OTHERWISE SPECIFIED:		DWN		Tyco Electronics	
mm		Ø PLC	±	Raab, S.	17SEP2008	Tyco Electronics AMP GmbH 64625 Bensheim (Germany)	
		1 PLC	±	CHK	22SEP2008	NAME	
		2 PLC	±	Goeppel, C.		6-poliges POSITIVE LOCK Gehaeuse der Serie 6.3 (.250)	
		3 PLC	±	APVD	23SEP2008	SIZE	CAGE CODE
		4 PLC	±	Bleicher, M.		A2	00779
		ANGLES	±1.5°	PRODUCT SPEC		DRAWING NO	926330
		FINISH		APPLICATION SPEC		RESTRICTED TO	-
MATERIAL	-	WEIGHT	3.7 g	SCALE	2:1	SHEET	1 OF 1
		CUSTOMER DRAWING		REV	F1		