

## Mod. G7580 - Fittings Series 7000 - Automation

Product code: G7580 12

Datasheet creation date: 12/12/2025 08:33

Check the most updated document online [click here](#)



### ■ TECHNICAL DATA

Mod.	G7580 12
------	----------

## Mod. G7580 - Fittings Series 7000 - Automation

Product code: G7580 12

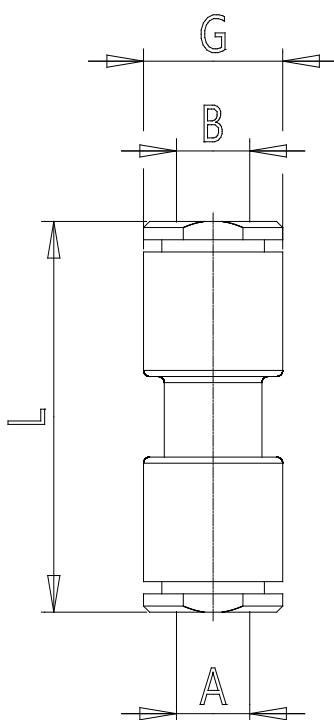

### **DIMENSIONS**

<b>A (mm)</b>	12
<b>B (mm)</b>	12
<b>GD (mm)</b>	20.0
<b>L (mm)</b>	46.0
<b>Weight (g)</b>	9.0