

# ULTRA MINIATURE RELAY

## 2 POLES - 2 A (Low Profile Signal Relay)

### FTR-B3 Series

#### ■ FEATURES

- DPDT 2C
- Ultra miniature low profile relay with high heat resistant material
- Height: 5.45mm, Weight: 0.85g, Mounting space: 87mm<sup>2</sup>
- Adopted superior contact spring for high frequency characteristic
- Comply with Telcordia / FCC standard
  - Isolation distance: min. 1.6mm
  - Dielectric strength between coil and contact: 1500VAC
  - Surge strength: 2500V
- Low power: Non-latching: 140mW (230mW at 24V)  
Latching: 100mW (120mW at 24V)
- High reliable bifurcated gold overlay silver contact
- UL, CSA recognized. Confirms to IEC 60950, UL1950, EN60950. Spacing & high breakdown voltage (basic insulation, 150 working volts, pollution degree 2)
- RoHS compliant.  
Please see page 9 for more information

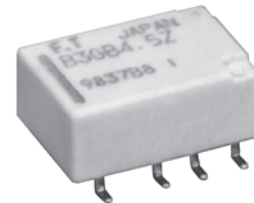

#### ■ PARTNUMBER INFORMATION

**[Example]**      FTR-B3    G   B   012   Z   -   B   10  
                   (a)    (b) (c)   (d)   (e)    (f)   (g)

(a)	Relay type	FTR-B3 : FTR-B3-Series
(b)	Terminal type	C : Through hole G : Surface mount S : Surface mount, space saving
(c)	Coil type	A : Standard type B : Latching type (1 coil)
(d)	Coil rated voltage	012 : 1.5.....24 VDC Coil rating table at page 3
(e)	Contact material	Z : Gold overlay silver nickel P : Gold overlay silver palladium
(f)	Relay enclosing direction *1	B : Standard enclosing direction
(g)	Number of relays per reel *2	10 : 1,000 (standard)

Remarks: Actual marking on relay would not carry code FTR and be as below:  
 Ordering code: FTR-B3GB012Z-B10    Actual marking: B3GB012Z

\* 1 Only surface mount types (G and S) are applicable

\* 2 All relays are packaged in tubes unless part number ends with -B10 (50 relays per tube).

# FTR-B3 SERIES

## ■ SPECIFICATION

Item			Standard type	Latching type
			FTR-B3 ( ) A	FTR-B3 ( ) B
Contact Data	Configuration		2 form C	
	Construction		Bifurcated contacts (cross-bar)	
	Material		Gold overlay silver nickel / Gold overlay silver palladium	
	Resistance (initial)		Max. 75 mΩ at 1 A, 6 VDC	
	Contact rating (resistive)		30VDC, 1A / 125VAC, 0.3A	
	Max. carrying current		2A	
	Max. switching voltage		250 VAC / 220VDC	
	Max. switching power		62.5VA / 30W	
	Min. switching load *		0.01mA, 10mVDC	
Life	Mechanical		Min. 50 x 10 <sup>6</sup> operations (at 3Hz)	Min. 20 x 10 <sup>6</sup> operations (at 3Hz)
	Electrical		Min. 100 x 10 <sup>3</sup> operations at 1A 30VDC (at 0.5Hz) Min. 100 x 10 <sup>3</sup> operations at 0.3A 125VDC (at 0.5Hz)	
Coil Data	Rated power		140mW - 230mW	100mW - 120mW
	Operate power		80mW - 130mW	57mW - 68mW
	Operating temperature range		-40 °C to +85 °C (no frost)	
Timing Data	Operate (at nominal voltage)		Max. 3 ms (without bounce)	
	Release (at nominal voltage)		Max. 3 ms (without bounce)	
Insulation	Resistance (initial)		Min. 1,000MΩ at 500VDC	
	Dielectric strength	Open contacts	1,000VAC (50/60Hz) 1min	
		Contacts to coil	1,500VAC (50/60Hz) 1min	
		Adjacent contacts	1,000VAC (50/60Hz) 1min.	
	Surge strength	Coil to contacts	2,500V, 2 x 10μs standard wave	
		Adjacent contacts	1.0 mm	
	Clearance	Open contacts	0.28 mm	
		Coil and contacts	1.0 mm	
		Adjacent contacts	1.0 mm	
	Creepage	Open contacts	0.28 mm	
Coil and contacts		1.60 mm		
Adjacent contacts		1.0 mm		
Other	Vibration resistance	Misoperation	10 to 55Hz double amplitude 3.3mm	
		Endurance	10 to 55Hz double amplitude 5.0mm	
	Shock	Misoperation	750m/s <sup>2</sup>	
		Endurance	1,000m/s <sup>2</sup>	
	Weight	Approximately 0.8 g		

\* Minimum switching loads mentioned above are reference values. Please perform the confirmation test with actual load before production since reference values may vary according to switching frequencies, environmental conditions and expected reliability levels.

# FTR-B3 SERIES

## ■ COIL RATING

Standard type

Coil Code	Rated Coil Voltage (VDC)	Coil Resistance +/- 10% (Ohm)	Must Operate Voltage (VDC) *	Must Release Voltage (VDC) *	Max. Coil Voltage (VDC)	Rated Power (mW)
1.5	1.5	16.1	1.13	0.15	3.53	140
003	3	64.3	2.25	0.3	7.05	
4.5	4.5	145	3.38	0.45	10.58	
006	6	257	4.5	0.6	14.10	
009	9	579	6.75	0.9	21.15	
012	12	1,028	9	1.2	28.20	
024	24	2,504	18	2.4	56.40	230

Latching type (1 coil)

Coil Code	Rated Coil Voltage (VDC)	Coil Resistance +/- 10% (Ohm)	Must Operate Voltage (VDC) *	Must Release Voltage (VDC) *	Max. Coil Voltage (VDC)	Rated Power (mW)
1.5	1.5	22.5	1.13	-0.13	3.53	100
003	3	90	2.25	-2.25	7.05	
4.5	4.5	203	3.38	-3.38	10.58	
006	6	360	4.5	-4.5	14.10	
009	9	810	6.75	-6.75	21.15	
012	12	1,440	9	-9	28.20	
024	24	4,800	18	-18	56.40	120

Note: All values in the table are valid for 20°C and zero contact current.

\* Specified operate values are valid for pulse wave voltage.

## ■ SAFETY STANDARDS

Type	Compliance	Contact rating
UL	UL 508	Flammability: UL 94-V0 (plastics)
	E 63615	0.5A, 125VAC (resistive) 1A, 30VDC (resistive)
CSA	C22.2 No. 14 LR 40304-58	0.3A, 110VDC (resistive) 2A, 30VDC (resistive)

# FTR-B3 SERIES

## CHARACTERISTIC DATA

- Standard type

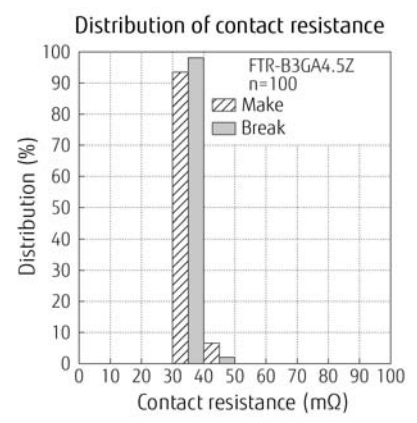
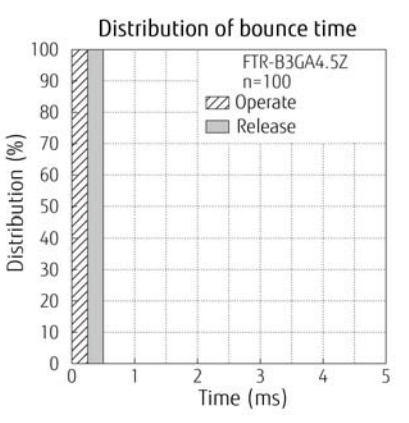
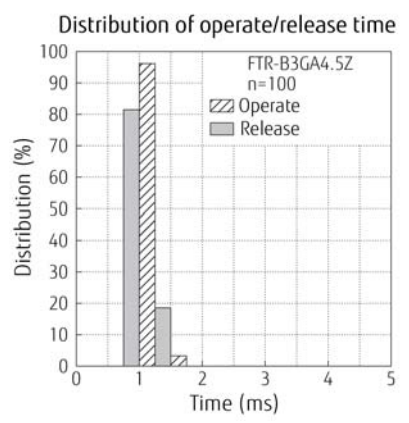
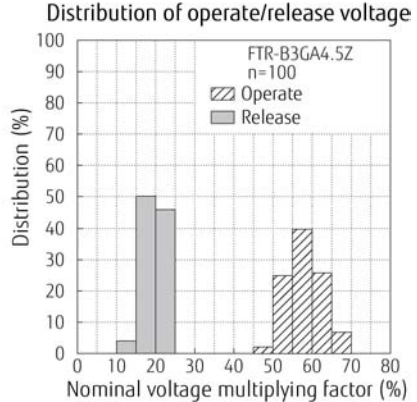
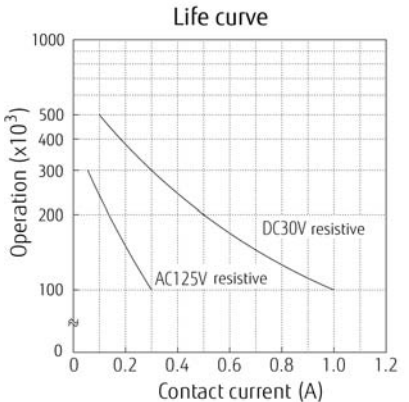
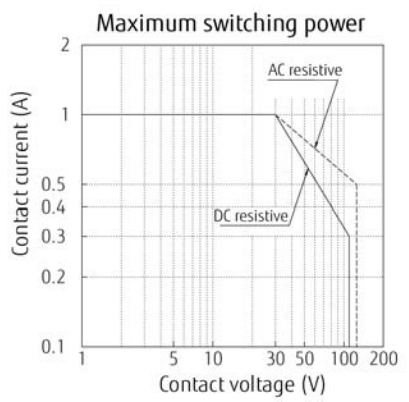
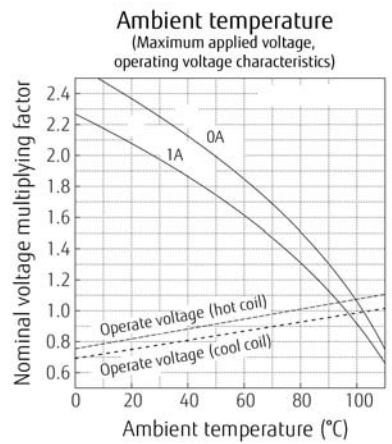
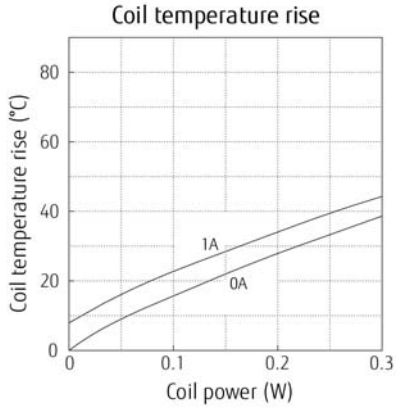
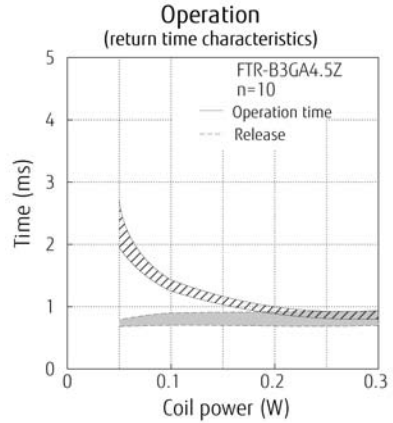

# FTR-B3 SERIES

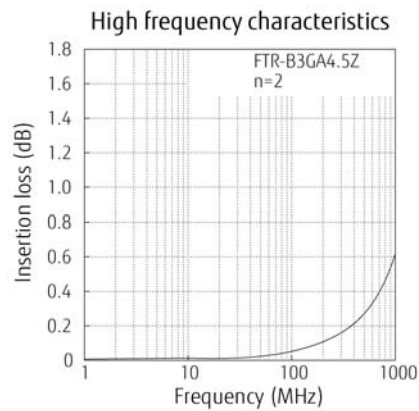
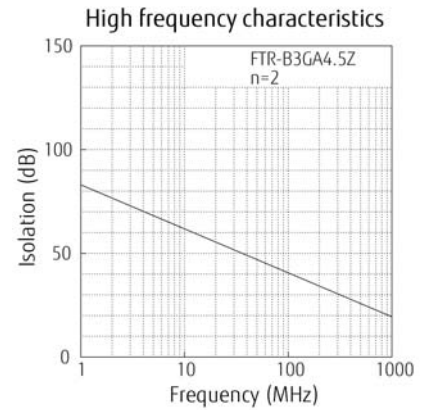
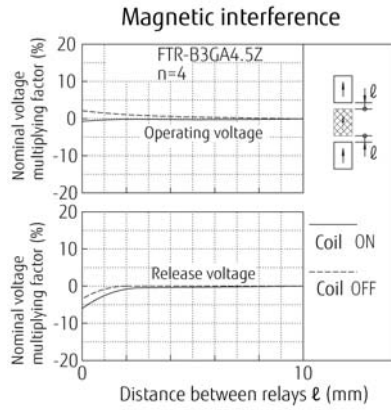
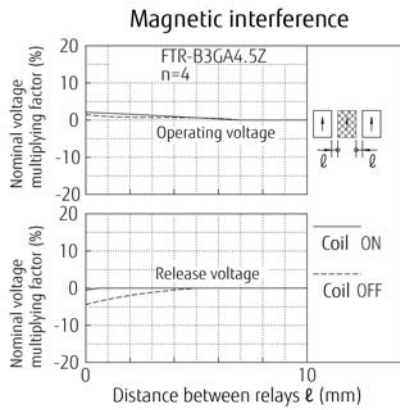

- Latching type

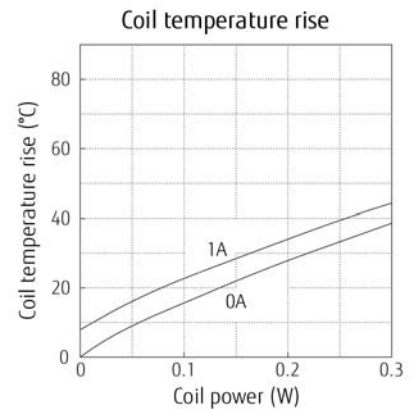
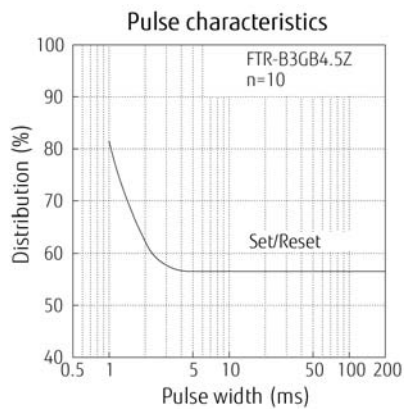
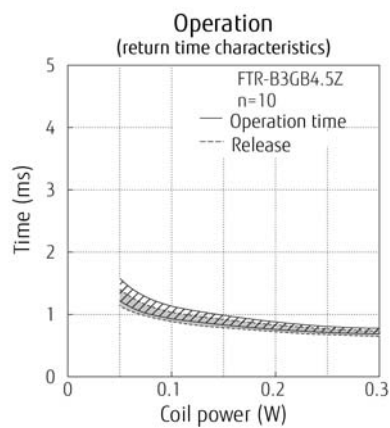

# FTR-B3 SERIES

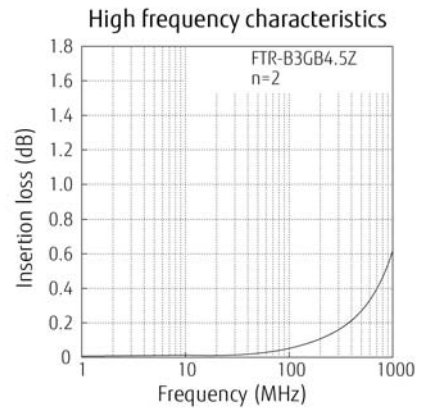
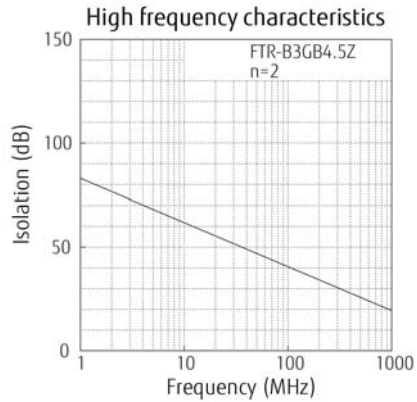
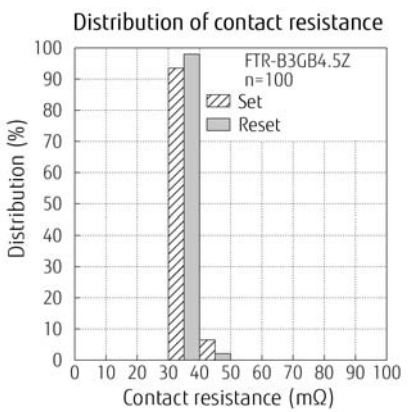
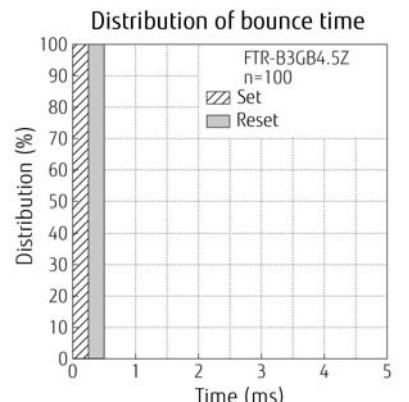
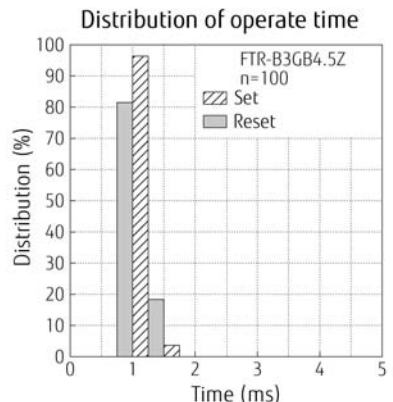
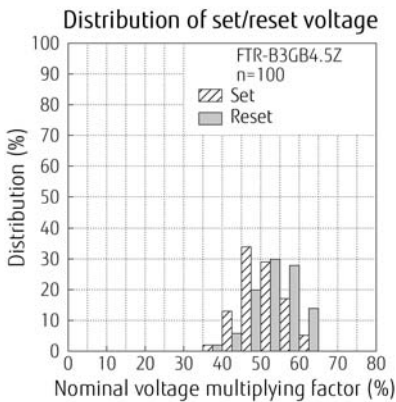
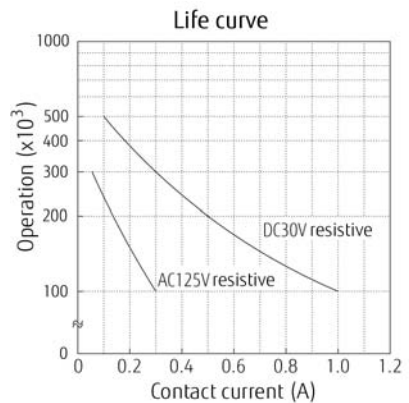
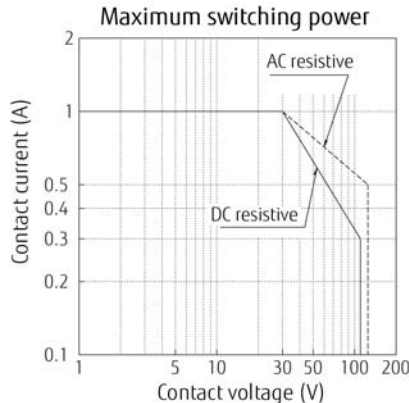
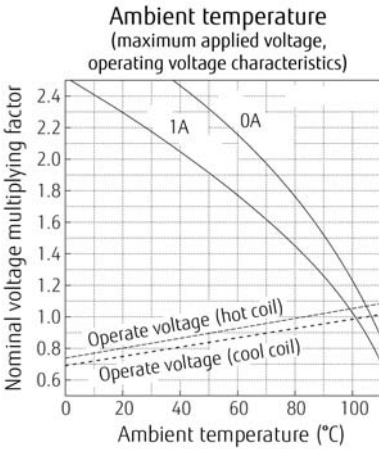

# FTR-B3 SERIES

## ■ DIMENSIONS

FTR-B3C - Through hole type

- Dimensions

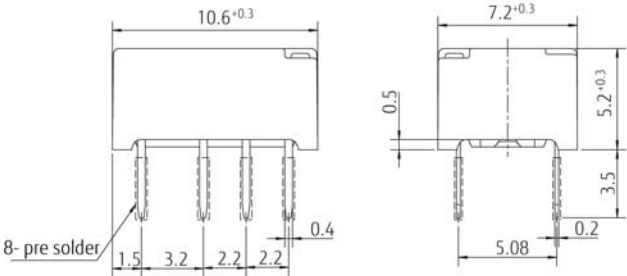

- Schematics \*  
(BOTTOM VIEW)

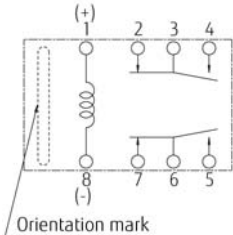

- PC board mounting hole layout  
(BOTTOM VIEW)

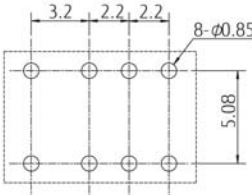

FTR-B3G - Surface mount type

- Dimensions

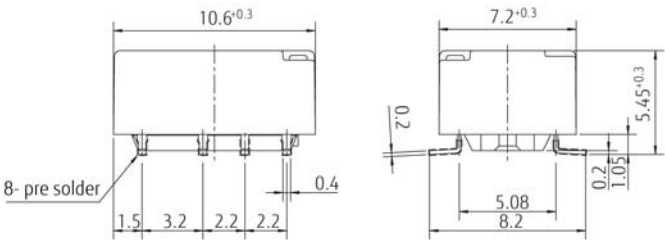

- Schematics \*  
(TOP VIEW)

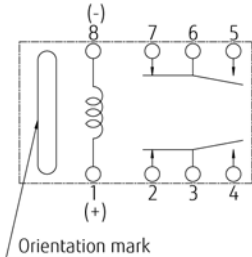

- PC board mounting pad layout  
(TOP VIEW)

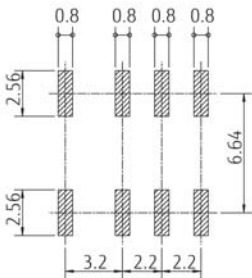

FTR-B3S - Space saving type

- Dimensions

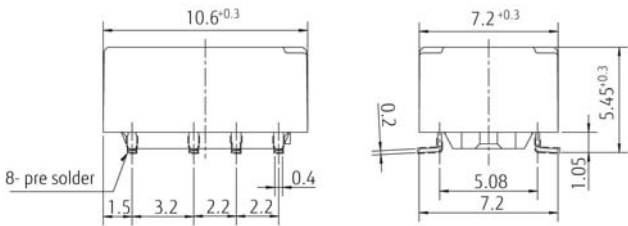

- Schematics \*  
(TOP VIEW)

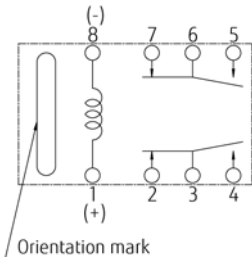

- PC board mounting pad layout  
(TOP VIEW)

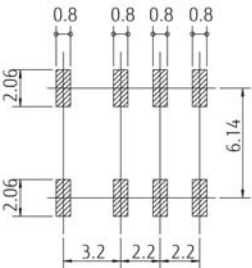

\* Indicates reset state for latching relays (FTR-B3CB, FTR-B3GB and FTR-B3SB versions)  
Indicates non-operate state for standard relays (FTR-B3CA, FTR-B3GA and FTR-B3SA versions)

Unit: mm

## ■ COIL POLARITY LATCHING TYPE

Coil terminal	1	8
Set	+	-
Reset	-	+

## ■ RECOMMENDED SOLDERING CONDITIONS FOR SMT (SEE PAGE 9) (TEMPERATURE PROFILE)

Notes:

1. Temperature profiles on page 9 show the temperature of PC board surface.
2. Please perform soldering test with your actual PC board before mass production, since the temperatures of PC board surfaces vary according to the size of PC board, status of parts mounting and heating method.

## ■ PRECAUTIONS

- For details on general precautions, refer to the section on technical descriptions.
- Since this is a polarized relay, follow the instructions of the internal wiring diagram for the  $\pm$  connections of the coil.
- Note that the terminal layout and internal wiring of the surface mount relay are a top view.
- SMT versions of the FTR-B3 relays have moisture sensitivity level 3, acc. JEDEC-J-STD-020D
- SMT versions of the FTR-B3 relays will be shipped in "dry pack". Relays have an "out bag" storage time of 192h.

## ■ PACKAGING SPECIFICATIONS

### ● Packaging method

- Packaging standard: JIS C 0806
- Taping type: TB 1612
- Reel type: R16D
- Quantity of 1 reel: 1000 pieces

### ● Packaging orientation code: B

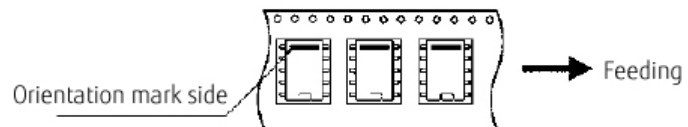

### ● Reel dimensions

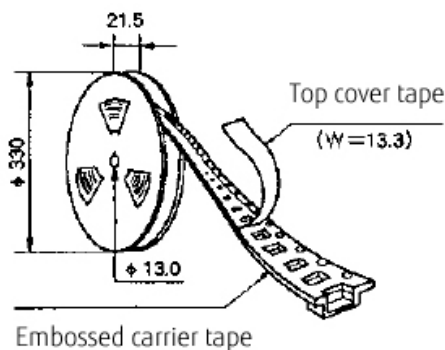

### ● Tape dimensions

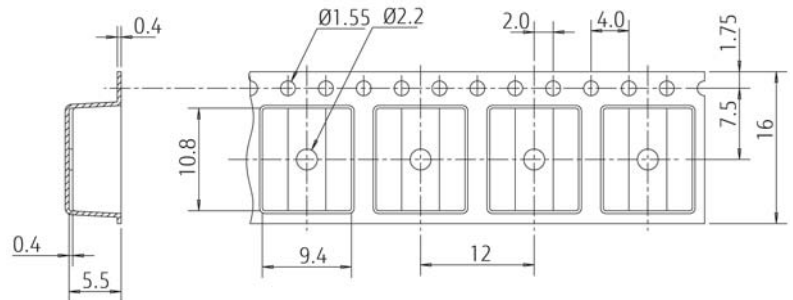

Unit: mm

Note:

Relays are sold in 1000 pieces per box. Minimum order quantity is 1000 pieces for tube and tape & reel packing.



## RoHS Compliance and Lead Free Information

### 1. General Information

- All signal and power relays produced by Fujitsu Components are compliant with RoHS directive 2002/95/EC including amendments.
- Cadmium as used in electrical contacts is exempted from the RoHS directives on October 21st, 2005. (Amendment to Directive 2002/95/EC)
- All of our signal and power relays are lead-free. Please refer to Lead-Free Status Info for older date codes at: <http://www.fujitsu.com/us/downloads/MICRO/fcai/relays/lead-free-letter.pdf>
- Lead free solder plating on relay terminals is Sn-3.0Cu-Ni for FTR-B3 and FTR-B4 series relays. This material has been verified to be compatible with PbSn assembly process.

### 2. Recommended Lead Free Solder Profile

- Recommended solder Sn-3.0Ag-0.5Cu or Sn-3.0 Cu-Ni (only FTR-B3 and FTR-B4)

#### Reflow Solder condition

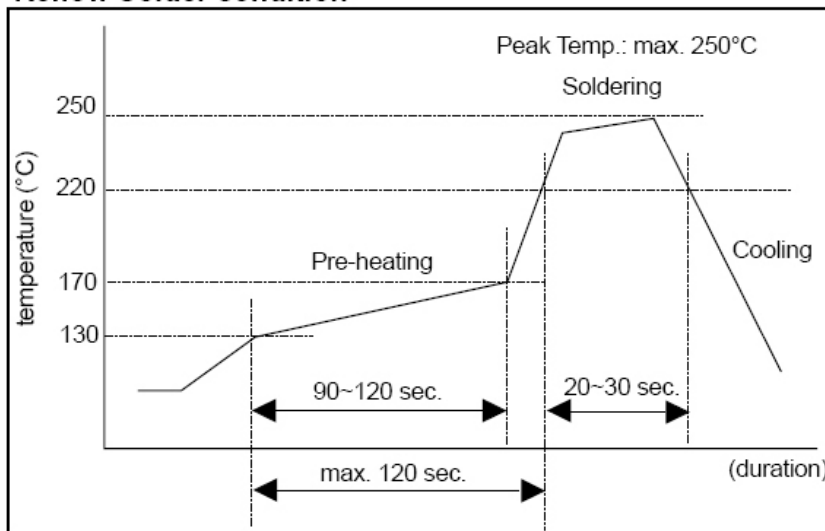

#### Flow Solder condition:

Pre-heating: maximum 120°C  
Soldering: dip within 5 sec. at 260°C solder bath

#### Solder by Soldering Iron:

Soldering Iron  
Temperature: maximum 360°C  
Duration: maximum 3 sec.

**We highly recommend that you confirm your actual solder conditions**

### 3. Moisture Sensitivity

- Moisture Sensitivity Level standard is not applicable to electromechanical relays, unless otherwise indicated.

### 4. Tin Whiskers

- Dipped SnAgCu solder is known as presenting a low risk to tin whisker development. No considerable length whisker was found by our in house test.

## Fujitsu Components International Headquarter Offices

### Japan

Fujitsu Component Limited  
Gotanda-Chuo Building  
3-5, Higashigotanda 2-chome, Shinagawa-ku  
Tokyo 141, Japan  
Tel: (81-3) 5449-7010  
Fax: (81-3) 5449-2626  
Email: [promothq@ft.ed.fujitsu.com](mailto:promothq@ft.ed.fujitsu.com)  
Web: [www.fcl.fujitsu.com](http://www.fcl.fujitsu.com)

### North and South America

Fujitsu Components America, Inc.  
250 E. Caribbean Drive  
Sunnyvale, CA 94089 U.S.A.  
Tel: (1-408) 745-4900  
Fax: (1-408) 745-4970  
Email: [components@us.fujitsu.com](mailto:components@us.fujitsu.com)  
Web: <http://us.fujitsu.com/components>

### Europe

Fujitsu Components Europe B.V.  
Diamantlaan 25  
2132 WV Hoofddorp  
Netherlands  
Tel: (31-23) 5560910  
Fax: (31-23) 5560950  
Email: [info@fceu.fujitsu.com](mailto:info@fceu.fujitsu.com)  
Web: [emea.fujitsu.com/components/](http://emea.fujitsu.com/components/)

### Asia Pacific

Fujitsu Components Asia Ltd.  
102E Pasir Panjang Road  
#01-01 Citilink Warehouse Complex  
Singapore 118529  
Tel: (65) 6375-8560  
Fax: (65) 6273-3021  
Email: [fcalfcal.fujitsu.com](mailto:fcalfcal.fujitsu.com)  
Web: <http://www.fujitsu.com/sg/services/micro/components/>

©2011 Fujitsu Components Europe B.V. All rights reserved. All trademarks or registered trademarks are the property of their respective owners.

The contents, data and information in this datasheet are provided by Fujitsu Component Ltd. as a service only to its user and only for general information purposes.

The use of the contents, data and information provided in this datasheet is at the users' own risk.

Fujitsu has assembled this datasheet with care and will endeavor to keep the contents, data and information correct, accurate, comprehensive, complete and up to date.

Fujitsu Components Europe B.V. and affiliated companies do however not accept any responsibility or liability on their behalf, nor on behalf of its employees, for any loss or damage, direct, indirect or consequential, with respect to this datasheet, its contents, data, and information and related graphics and the correctness, reliability, accuracy, comprehensiveness, usefulness, availability and completeness thereof.

Nor do Fujitsu Components Europe B.V. and affiliated companies accept on their behalf, nor on behalf of its employees, any responsibility or liability for any representation or warrant of any kind, express or implied, including warranties of any kind for merchantability or fitness for particular use, with respect to these datasheets, its contents, data, information and related graphics and the correctness, reliability, accuracy, comprehensiveness, usefulness, availability and completeness thereof. Rev. January 09, 2012