





Contact element, 1N/CL, front mount, screw connection



Part no. M22-K01D
Catalog No. 262165
Eaton Catalog No. M22-K01DQ

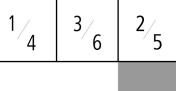

Delivery program

Product range		Accessories
Single unit/Complete unit		Element
Basic function accessories		Contact elements
Approval		
Connection technique		Screw terminals
Fixing		Front fixing
Contacts		
N/C = Normally closed		1 NC 
Notes		 = safety function, by positive opening to IEC/EN 60947-5-1
Actuator travel and actuation force as per DIN EN 60947-5-1, K.5.4.1		
	mm	4.8
Maximum travel	mm	5.7
Minimum force for positive opening	N	15

Contact sequence			
Contact travel diagram, stroke in connection with front element			
Configuration			
Degree of Protection			IP20
Connection to SmartWire-DT			no
Connection type			Single contact

Technical data

General

Standards			IEC 60947-5-1
Lifespan, mechanical	Operations	$\times 10^6$	> 5
Operating frequency	Operations/h		 3600
Actuating force	n		 5
Operating torque (screw terminals)	Nm		 0.8
Degree of Protection			IP20
Climatic proofing			Damp heat, constant, to IEC 60068-2-78 Damp heat, cyclic, to IEC 60068-2-30
Ambient temperature			
Open	°C		-25 - +70
Mechanical shock resistance to IEC 60068-2-27 Shock duration 11 ms, half-sinusoidal	g		> 30
Terminal capacities		mm ²	
Solid		mm ²	0.75 - 2.5
Stranded		mm ²	0.5 - 2.5
Flexible with ferrule		mm ²	0.5 - 1.5

Contacts

Rated impulse withstand voltage	U_{imp}	V AC	6000
Rated insulation voltage	U_i	V	500

Overvoltage category/pollution degree			III/3
Control circuit reliability			
at 24 V DC/5 mA	H _F	Fault probability	< 10 ⁻⁷ (i.e. 1 failure to 10 ⁷ operations)
at 5 V DC/1 mA	H _F	Fault probability	< 5 x 10 ⁻⁶ (i.e. 1 failure in 5 x 10 ⁶ operations)
Max. short-circuit protective device			
Fuseless		Type	PKZM0-10/FAZ-B6/1
Fuse	gG/gL	A	10

Switching capacity

Rated operational current	I _e	A	
AC-15			
115 V	I _e	A	6
220 V 230 V 240 V	I _e	A	6
380 V 400 V 415 V	I _e	A	4
500 V	I _e	A	2
DC-13			
24 V	I _e	A	3
42 V	I _e	A	1.7
60 V	I _e	A	1.2
110 V	I _e	A	0.6
220 V	I _e	A	0.3
Lifespan, electrical			
AC-15			
230 V/0.5 A	Operations	x 10 ⁶	1.6
230 V/1.0 A	Operations	x 10 ⁶	1
230 V/3.0 A	Operations	x 10 ⁶	0.7
DV-13			
12 V/2.8 A	Operations	x 10 ⁶	1.2

Auxiliary contacts

Rated conditional short-circuit current	I _q	kA	1
---	----------------	----	---

Design verification as per IEC/EN 61439

Technical data for design verification			
Rated operational current for specified heat dissipation	I _n	A	6
Heat dissipation per pole, current-dependent	P _{vid}	W	0.11
Equipment heat dissipation, current-dependent	P _{vid}	W	0
Static heat dissipation, non-current-dependent	P _{vs}	W	0
Heat dissipation capacity	P _{diss}	W	0
Operating ambient temperature min.		°C	-25
Operating ambient temperature max.		°C	70
IEC/EN 61439 design verification			
10.2 Strength of materials and parts			
10.2.2 Corrosion resistance			Meets the product standard's requirements.
10.2.3.1 Verification of thermal stability of enclosures			Meets the product standard's requirements.
10.2.3.2 Verification of resistance of insulating materials to normal heat			Meets the product standard's requirements.
10.2.3.3 Verification of resistance of insulating materials to abnormal heat and fire due to internal electric effects			Meets the product standard's requirements.
10.2.4 Resistance to ultra-violet (UV) radiation			Meets the product standard's requirements.
10.2.5 Lifting			Does not apply, since the entire switchgear needs to be evaluated.
10.2.6 Mechanical impact			Does not apply, since the entire switchgear needs to be evaluated.
10.2.7 Inscriptions			Meets the product standard's requirements.
10.3 Degree of protection of ASSEMBLIES			Does not apply, since the entire switchgear needs to be evaluated.
10.4 Clearances and creepage distances			Meets the product standard's requirements.
10.5 Protection against electric shock			Does not apply, since the entire switchgear needs to be evaluated.

10.6 Incorporation of switching devices and components		Does not apply, since the entire switchgear needs to be evaluated.
10.7 Internal electrical circuits and connections		Is the panel builder's responsibility.
10.8 Connections for external conductors		Is the panel builder's responsibility.
10.9 Insulation properties		
10.9.2 Power-frequency electric strength		Is the panel builder's responsibility.
10.9.3 Impulse withstand voltage		Is the panel builder's responsibility.
10.9.4 Testing of enclosures made of insulating material		Is the panel builder's responsibility.
10.10 Temperature rise		The panel builder is responsible for the temperature rise calculation. Eaton will provide heat dissipation data for the devices.
10.11 Short-circuit rating		Is the panel builder's responsibility. The specifications for the switchgear must be observed.
10.12 Electromagnetic compatibility		Is the panel builder's responsibility. The specifications for the switchgear must be observed.
10.13 Mechanical function		The device meets the requirements, provided the information in the instruction leaflet (IL) is observed.

Technical data ETIM 6.0

Low-voltage industrial components (EG000017) / Auxiliary contact block (EC000041)

Electric engineering, automation, process control engineering / Low-voltage switch technology / Component for low-voltage switching technology / Auxiliary switch block (ecl@ss8.1-27-37-13-02 [AKN342010])

Number of contacts as change-over contact		0
Number of contacts as normally open contact		0
Number of contacts as normally closed contact		1
Rated operation current I _e at AC-15, 230 V	A	6
Type of electric connection		Screw connection
Model		Top mounting
Mounting method		Front fastening

Approvals

Product Standards		IEC/EN 60947-5; UL 508; CSA-C22.2 No. 14-05; CSA-C22.2 No. 94-91; CE marking
UL File No.		E29184
UL Category Control No.		NKCR
CSA File No.		012528
CSA Class No.		3211-03
North America Certification		UL listed, CSA certified
Degree of Protection		UL/CSA Type: -

Dimensions

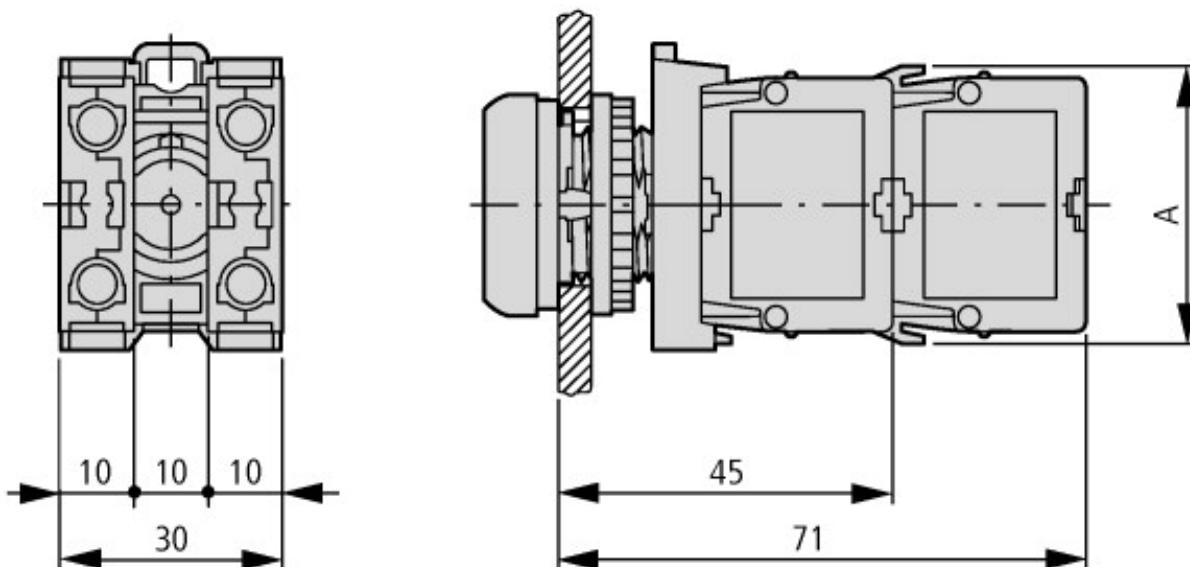

A = 37.2

Pushbutton with M22-(C)K...
Pushbutton with M22-(C) LED... + M22-XLED...

Additional product information (links)

IL04716002Z (AWA1160-1745) RMQ-Titan System

IL04716002Z (AWA1160-1745) RMQ-Titan
System

ftp://ftp.moeller.net/DOCUMENTATION/AWA_INSTRUCTIONS/IL04716002Z2017_01.pdf