

SEMiX303GB12E4p



SEMiX® 3p

Trench IGBT Modules

SEMiX303GB12E4p

Features

- Homogeneous Si
- Trench = Trenchgate technology
- $V_{CE(sat)}$ with positive temperature coefficient
- High short circuit capability
- Press-fit pins as auxiliary contacts
- UL recognized, file no. E63532

Typical Applications*

- AC inverter drives
- UPS
- Renewable energy systems

Remarks

- Product reliability results are valid for $T_j=150^\circ\text{C}$
- V_{isol} between temperature sensor and power section is only 2500V

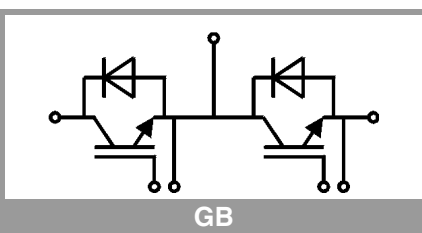

GB

Absolute Maximum Ratings			
Symbol	Conditions	Values	Unit
IGBT			
V_{CES}	$T_j = 25^\circ\text{C}$	1200	V
I_C	$T_j = 175^\circ\text{C}$	$T_c = 25^\circ\text{C}$	469
		$T_c = 80^\circ\text{C}$	361
I_{Cnom}		300	A
I_{CRM}	$I_{CRM} = 3 \times I_{Cnom}$	900	A
V_{GES}		-20 ... 20	V
t_{psc}	$V_{CC} = 800\text{ V}$ $V_{GE} \leq 20\text{ V}$ $V_{CES} \leq 1200\text{ V}$	$T_j = 150^\circ\text{C}$	10
			μs
T_j		-40 ... 175	$^\circ\text{C}$
Inverse diode			
V_{RRM}	$T_j = 25^\circ\text{C}$	1200	V
I_F	$T_j = 175^\circ\text{C}$	$T_c = 25^\circ\text{C}$	378
		$T_c = 80^\circ\text{C}$	284
I_{Fnom}		300	A
I_{FRM}	$I_{FRM} = 3 \times I_{Fnom}$	900	A
I_{FSM}	$t_p = 10\text{ ms, sin } 180^\circ, T_j = 25^\circ\text{C}$	1485	A
T_j		-40 ... 175	$^\circ\text{C}$
Module			
$I_{t(RMS)}$		600	A
T_{stg}		-40 ... 125	$^\circ\text{C}$
V_{isol}	AC sinus 50Hz, $t = 1\text{ min}$	4000	V

Characteristics					
Symbol	Conditions	min.	typ.	max.	Unit
IGBT					
$V_{CE(sat)}$	$I_C = 300\text{ A}$ $V_{GE} = 15\text{ V}$ chipelevel	$T_j = 25^\circ\text{C}$	1.80	2.05	V
		$T_j = 150^\circ\text{C}$	2.20	2.40	V
V_{CE0}	chipelevel	$T_j = 25^\circ\text{C}$	0.8	0.9	V
		$T_j = 150^\circ\text{C}$	0.7	0.8	V
r_{CE}	$V_{GE} = 15\text{ V}$ chipelevel	$T_j = 25^\circ\text{C}$	3.3	3.8	$\text{m}\Omega$
		$T_j = 150^\circ\text{C}$	5	5.3	$\text{m}\Omega$
$V_{GE(th)}$	$V_{GE}=V_{CE}, I_C = 11.4\text{ mA}$	5	5.8	6.5	V
I_{CES}	$V_{GE} = 0\text{ V}$ $V_{CE} = 1200\text{ V}$	$T_j = 25^\circ\text{C}$		4	mA
		$T_j = 150^\circ\text{C}$			mA
C_{ies}	$V_{CE} = 25\text{ V}$ $V_{GE} = 0\text{ V}$	$f = 1\text{ MHz}$	18.5		nF
C_{oes}		$f = 1\text{ MHz}$	1.22		nF
C_{res}		$f = 1\text{ MHz}$	1.04		nF
Q_G	$V_{GE} = -8\text{ V...} + 15\text{ V}$		1695		nC
R_{Gint}	$T_j = 25^\circ\text{C}$		2.50		Ω
$t_{d(on)}$	$V_{CC} = 600\text{ V}$	$T_j = 150^\circ\text{C}$	180		ns
t_r	$I_C = 300\text{ A}$ $V_{GE} = +15/-15\text{ V}$	$T_j = 150^\circ\text{C}$	55		ns
		$T_j = 150^\circ\text{C}$	23		mJ
E_{on}	$R_{Gon} = 1.3\ \Omega$	$T_j = 150^\circ\text{C}$			mJ
$t_{d(off)}$	$R_{Goff} = 1.3\ \Omega$	$T_j = 150^\circ\text{C}$	470		ns
t_f	$di/dt_{on} = 5600\text{ A}/\mu\text{s}$ $di/dt_{off} = 2400\text{ A}/\mu\text{s}$	$T_j = 150^\circ\text{C}$	110		ns
E_{off}	$du/dt = 3500\text{ V}/\mu\text{s}$ $L_s = 21\text{ nH}$	$T_j = 150^\circ\text{C}$	38		mJ
$R_{th(j-c)}$	per IGBT			0.094	K/W
$R_{th(c-s)}$	per IGBT ($\lambda_{grease}=0.81\text{ W}/(\text{m}^2\text{K})$)		0.03		K/W
$R_{th(c-s)}$	per IGBT, pre-applied phase change material		0.021		K/W



Trench IGBT Modules

SEMiX303GB12E4p

Features

- Homogeneous Si
- Trench = Trenchgate technology
- $V_{CE(sat)}$ with positive temperature coefficient
- High short circuit capability
- Press-fit pins as auxiliary contacts
- UL recognized, file no. E63532

Typical Applications*

- AC inverter drives
- UPS
- Renewable energy systems

Remarks

- Product reliability results are valid for $T_j=150^\circ\text{C}$
- V_{isol} between temperature sensor and power section is only 2500V

Characteristics						
Symbol	Conditions		min.	typ.	max.	Unit
Inverse diode						
$V_F = V_{EC}$	$I_F = 300\text{ A}$ $V_{GE} = 0\text{ V}$ chipelevel	$T_j = 25^\circ\text{C}$		2.20	2.52	V
		$T_j = 150^\circ\text{C}$		2.15	2.47	V
V_{F0}	chipelevel	$T_j = 25^\circ\text{C}$	1.1	1.3	1.5	V
		$T_j = 150^\circ\text{C}$	0.7	0.9	1.1	V
r_F	chipelevel	$T_j = 25^\circ\text{C}$	2.7	3	3.4	m Ω
		$T_j = 150^\circ\text{C}$	3.5	4.2	4.6	m Ω
I_{RRM}	$I_F = 300\text{ A}$	$T_j = 150^\circ\text{C}$		330		A
Q_{rr}	$di/dt_{off} = 6000\text{ A}/\mu\text{s}$	$T_j = 150^\circ\text{C}$		50		μC
E_{rr}	$V_{GE} = -15\text{ V}$ $V_{CC} = 600\text{ V}$	$T_j = 150^\circ\text{C}$		23		mJ
$R_{th(j-c)}$	per diode				0.15	K/W
$R_{th(c-s)}$	per diode ($\lambda_{grease}=0.81\text{ W}/(\text{m}^2\text{K})$)			0.046		K/W
$R_{th(c-s)}$	per diode, pre-applied phase change material			0.037		K/W
Module						
L_{CE}				20		nH
R_{CC+EE}	res. terminal-chip	$T_C = 25^\circ\text{C}$		1.2		m Ω
		$T_C = 125^\circ\text{C}$		1.65		m Ω
$R_{th(c-s)1}$	calculated without thermal coupling			0.009		K/W
$R_{th(c-s)2}$	including thermal coupling, T_s underneath module ($\lambda_{grease}=0.81\text{ W}/(\text{m}^2\text{K})$)			0.014		K/W
$R_{th(c-s)2}$	including thermal coupling, T_s underneath module, pre-applied phase change material			0.011		K/W
M_s	to heat sink (M5)		3		6	Nm
M_t		to terminals (M6)	3		6	Nm
						Nm
w					350	g
Temperature Sensor						
R_{100}	$T_c=100^\circ\text{C}$ ($R_{25}=5\text{ k}\Omega$)			$493 \pm 5\%$		Ω
$B_{100/125}$	$R_{(T)}=R_{100}\exp[B_{100/125}(1/T-1/T_{100})]$; $T[\text{K}]$;			3550 $\pm 2\%$		K

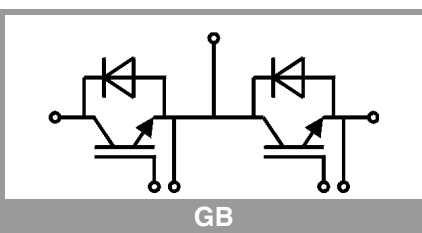

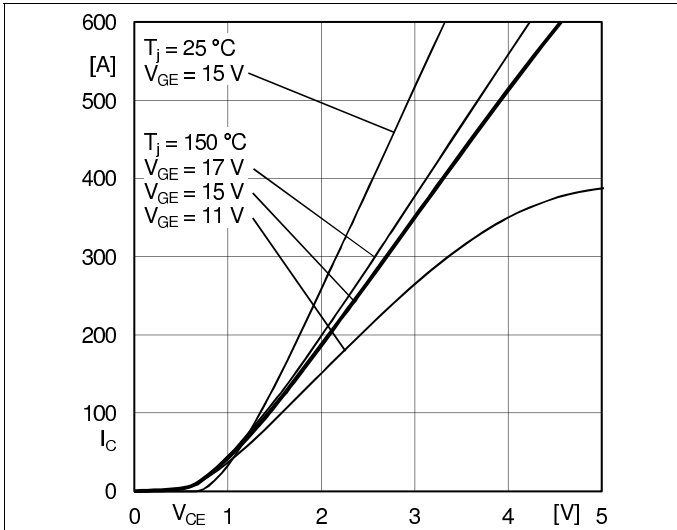

Fig. 1: Typ. output characteristic, inclusive $R_{CC'+EE'}$

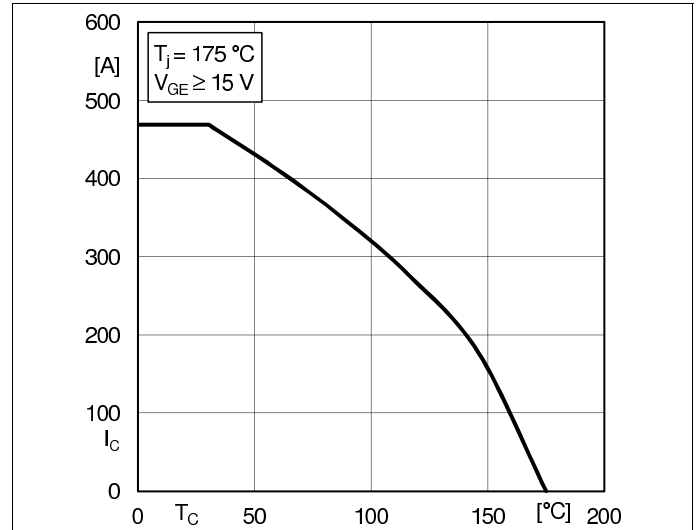

Fig. 2: Rated current vs. temperature $I_c = f(T_C)$

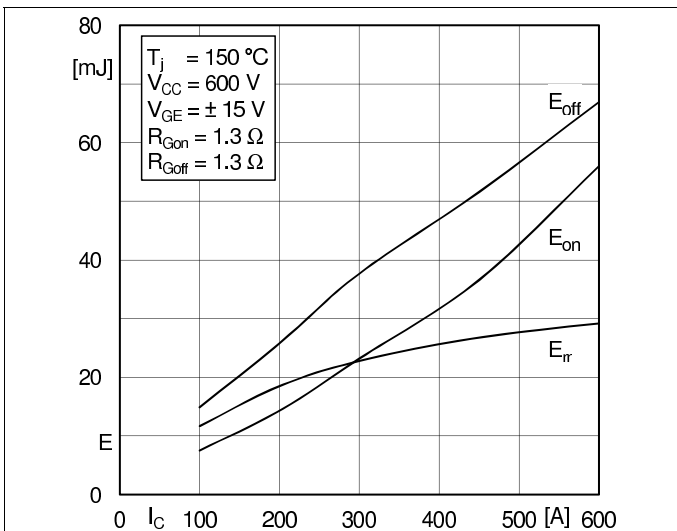

Fig. 3: Typ. turn-on /-off energy = $f(I_c)$

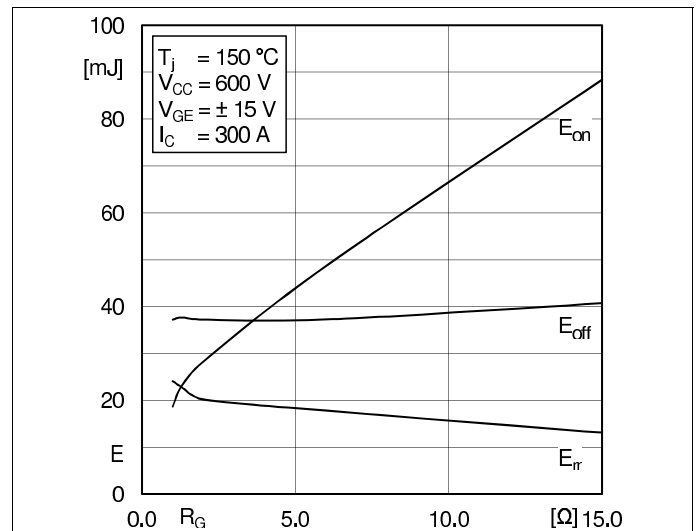

Fig. 4: Typ. turn-on /-off energy = $f(R_G)$

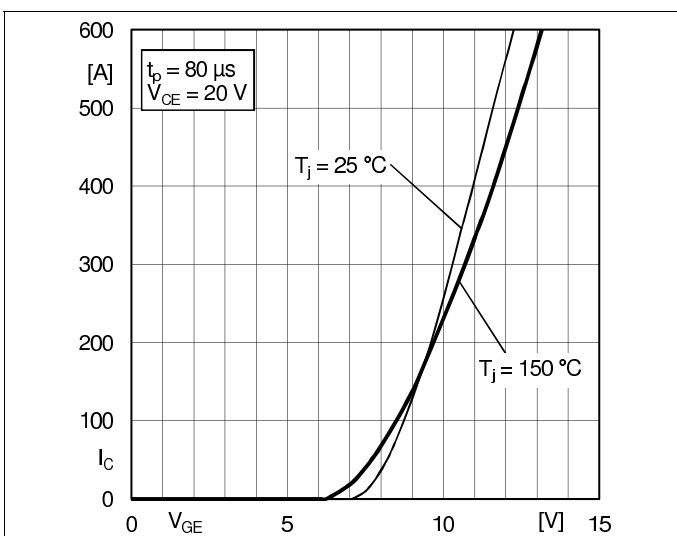

Fig. 5: Typ. transfer characteristic

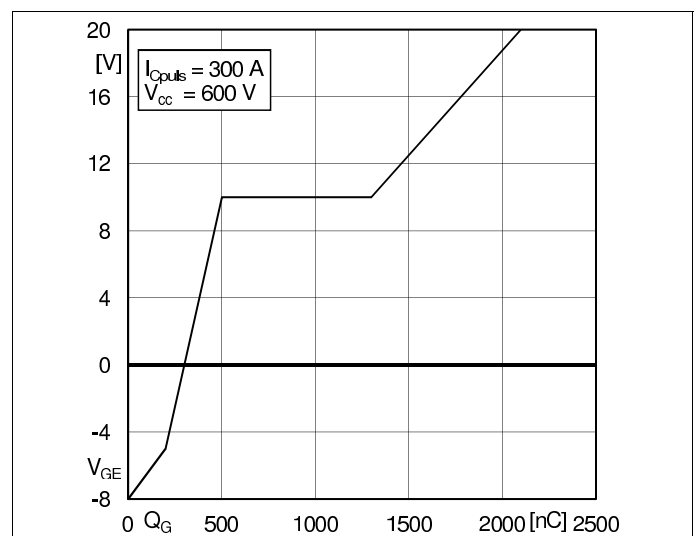

Fig. 6: Typ. gate charge characteristic

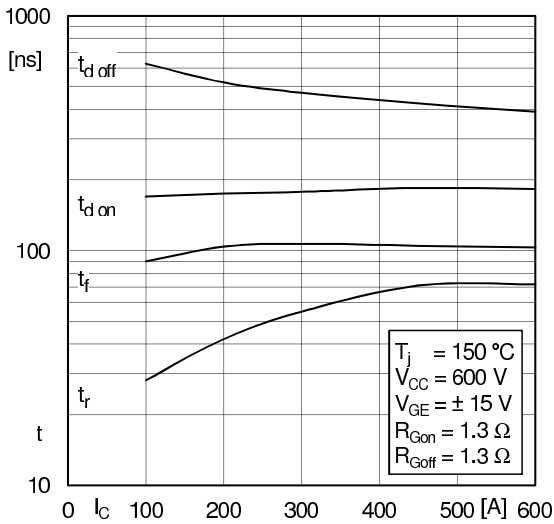

Fig. 7: Typ. switching times vs. I_c

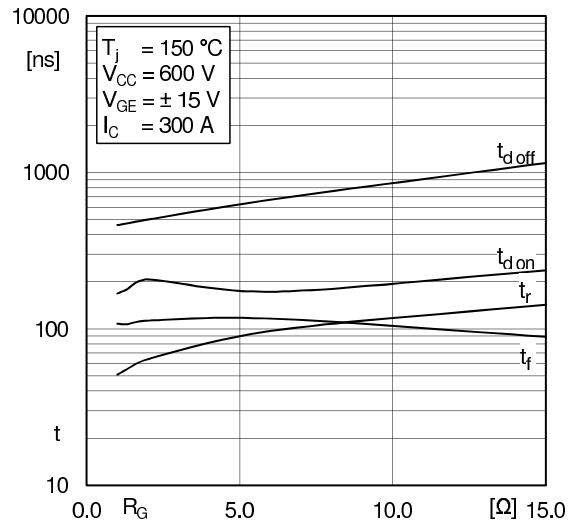

Fig. 8: Typ. switching times vs. gate resistor R_G

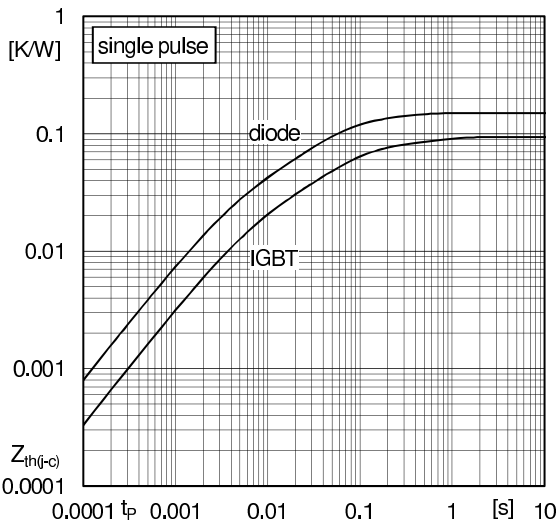

Fig. 9: Typ. transient thermal impedance

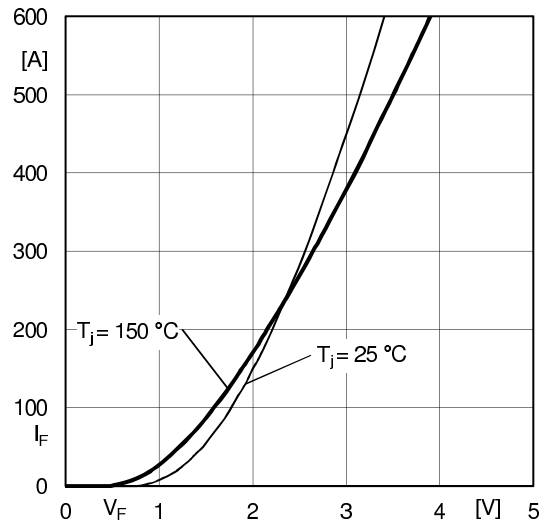

Fig. 10: Typ. CAL diode forward charact., incl. R_{CC+EE}

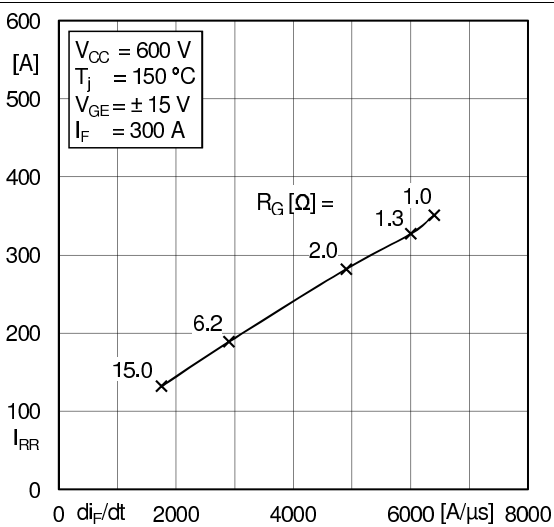

Fig. 11: Typ. CAL diode peak reverse recovery current

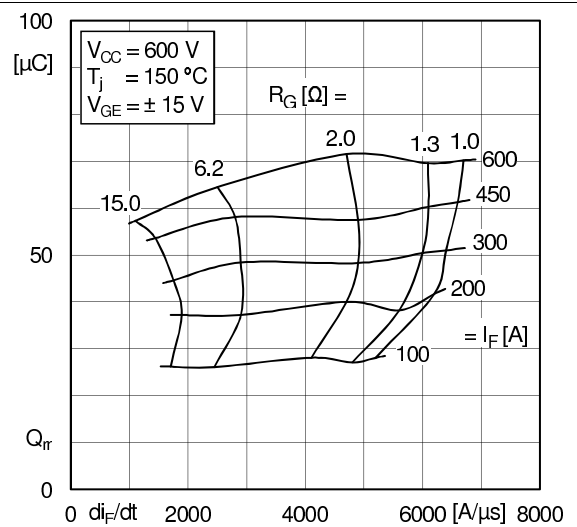

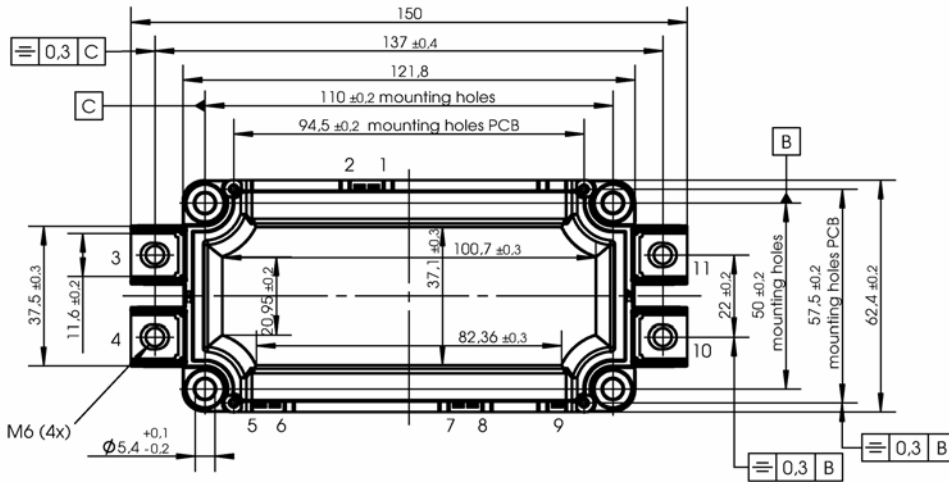
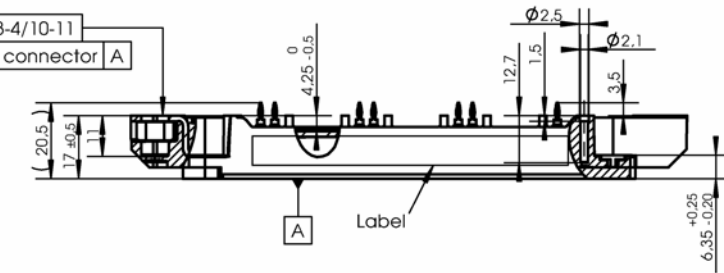

Fig. 12: Typ. CAL diode recovery charge

SEMiX303GB12E4p

Package outline

-  0.3 connector 3-4/10-11
-  0.2 each single connector A



PCB drillhole pattern

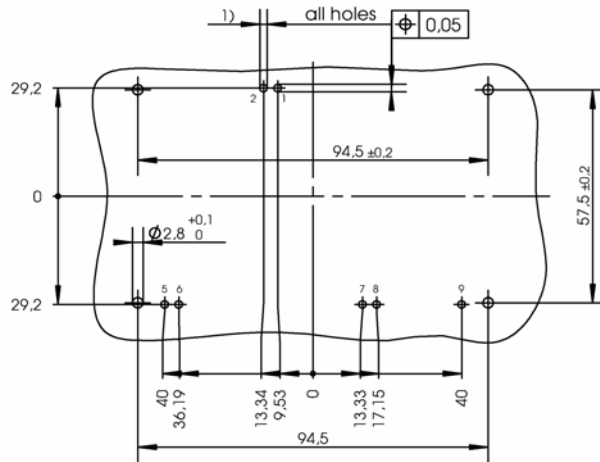

Dimensions valid in mounted status

1) PCB hole specification see Mounting Instructions SEMiX press-fit

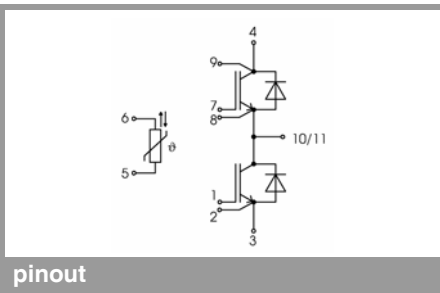

pinout

This is an electrostatic discharge sensitive device (ESDS), international standard IEC 60747-1, Chapter IX

* The specifications of our components may not be considered as an assurance of component characteristics. Components have to be tested for the respective application. Adjustments may be necessary. The use of SEMIKRON products in life support appliances and systems is subject to prior specification and written approval by SEMIKRON. We therefore strongly recommend prior consultation of our staff.